

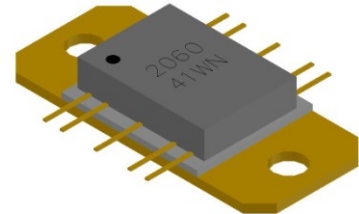

DESCRIPTION

AMCOM's AM206041WN-SN is a broadband GaN MMIC power amplifier. It has > 30dB gain, and > 41 dBm output power over the 1.75 to 6.5GHz band. The AM206041WN-SN-R is in a ceramic package version with a flange and straight RF and DC leads for drop-in assembly. Because of high DC power dissipation, good heat sinking is required. The package is RoHS compliant. This MMIC is matched to 50 Ohms.



FEATURES

- Broadband from 1.75 to 6.5GHz
- Saturated output power Psat is 43dBm
- High gain, 26dB
- Input & output matched to 50 Ohms

APPLICATIONS

- Instrumentation
- Commercial telecom transmission equipment
- Fixed microwave backhaul

TYPICAL PERFORMANCE

Parameters	Minimum	Typical **	Maximum
Frequency	2.5 – 6.0GHz	1.75 – 6.5GHz	
Small Signal Gain	26dB	30dB	33dB
Gain Ripple		± 1dB	± 3.0dB
P1dB	34dBm	38dBm	
Psat	37dBm	40dBm	
Psat Efficiency		23%	
Noise Figure		TBD	
IP3 dBm		47.5	
Input Return Loss	10dB	15dB	
Output Return Loss	4dB	8dB	
Thermal Resistance		TBD	

* Specifications subject to change without notice.

** Bias Conditions: $V_{ds1} = V_{ds2} = +28V$, $I_{dsq1} + I_{dsq2} = 0.6A$, $V_{gs1} \& V_{gs2} = -2.0V$, $V_{ds3} = +28V$, $I_{dsq3} = 0.9A$, $V_{gs3} = -2.0V$
Gate biases may change from chip to chip to get the specified currents

ABSOLUTE MAXIMUM RATING

Parameters	Symbol	Rating
First & second stage drain voltages	V_{ds1}, V_{ds2}	32V
Second stage drain voltage	V_{ds3}	32V
Gate source voltage	$V_{gs1} \& V_{gs2}$	-6V
Drain source current	$I_{dsq1} + I_{dsq2}$	0.75A
Drain source current	I_{dsq3}	1.1A
Continuous dissipation at 25°C	P_t	80W
Channel temperature	T_{ch}	200°C
Operating temperature	T_{op}	-55°C to +85°C
Storage temperature	T_{sto}	-55°C to +135°C

SMALL SIGNAL DATA*

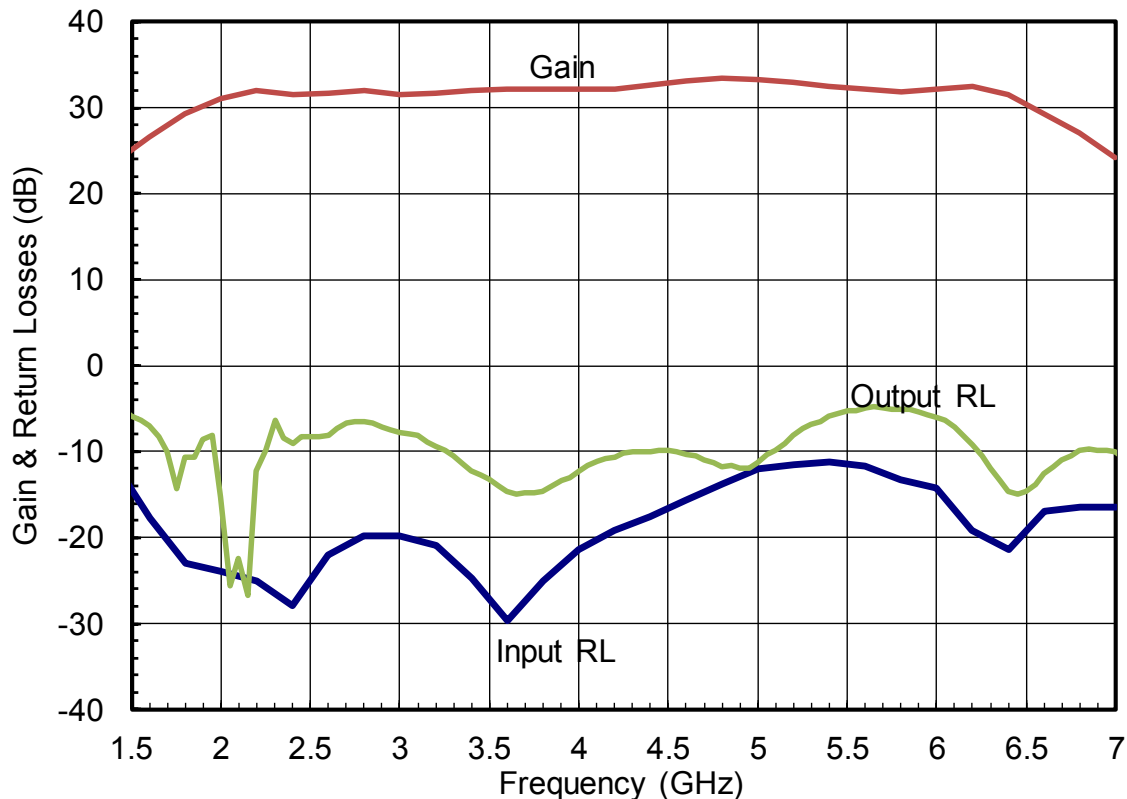

*S-Parameters measured using test fixture. Bias is $V_{ds1} = V_{ds2} = V_{ds3} = +28V$, $I_{ds1} + I_{ds2} = 600mA$, $I_{ds3} = 900mA$, $V_{gs1} = V_{gs2} = V_{gs3} = -2.0V$.

POWER DATA**

Vds= +28V

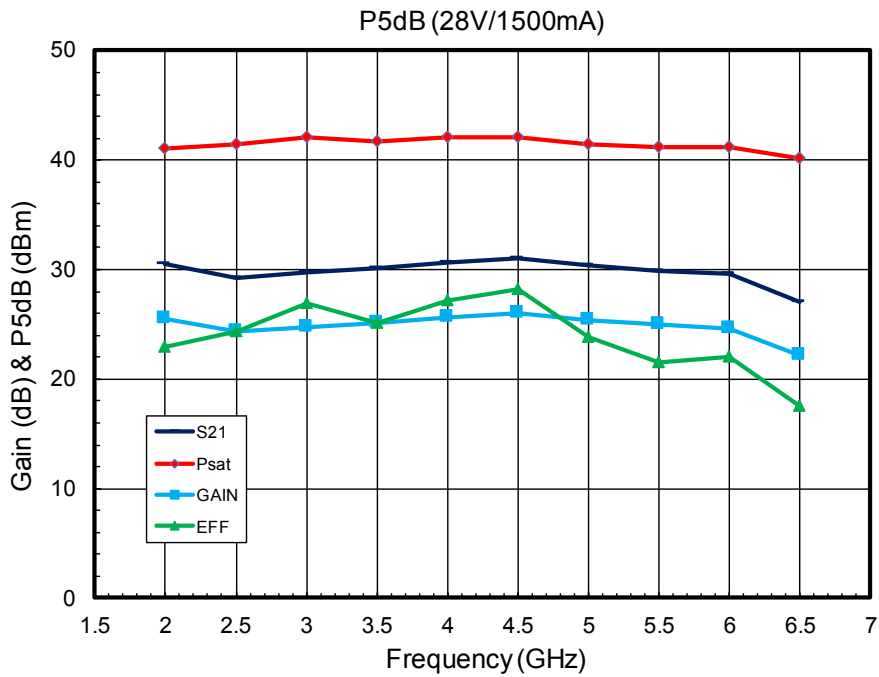
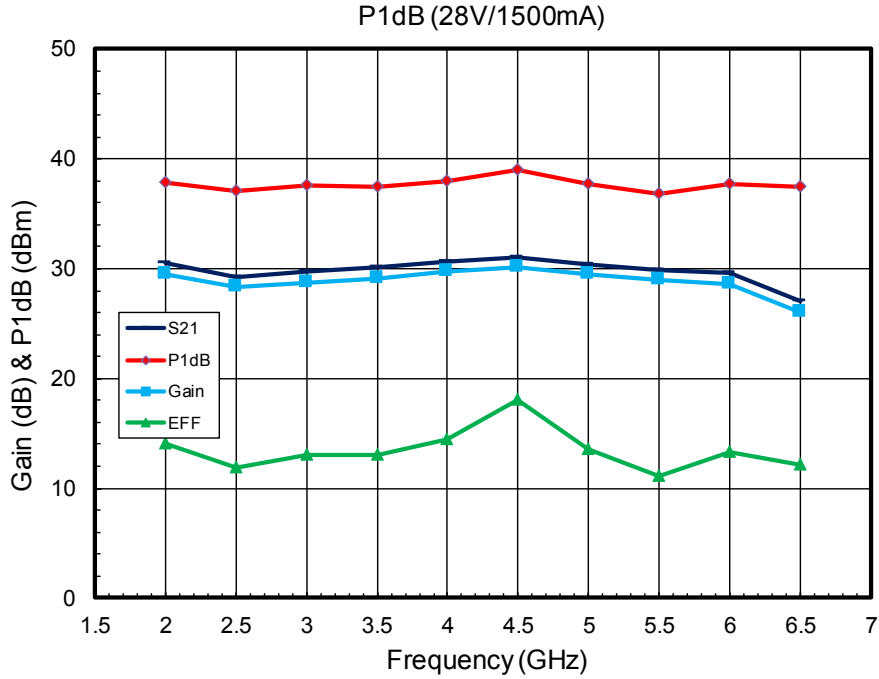

Vds= +20V

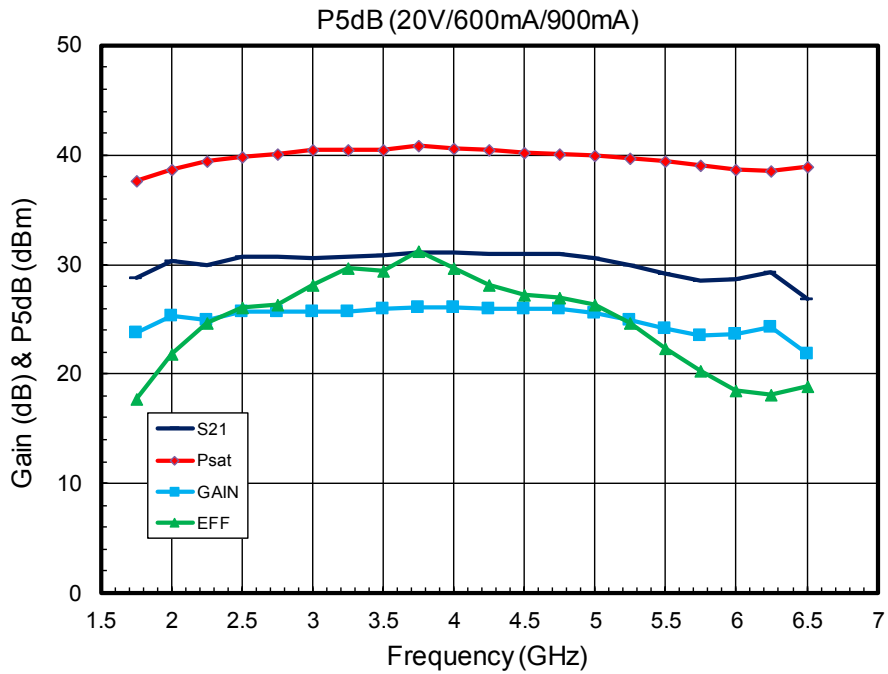
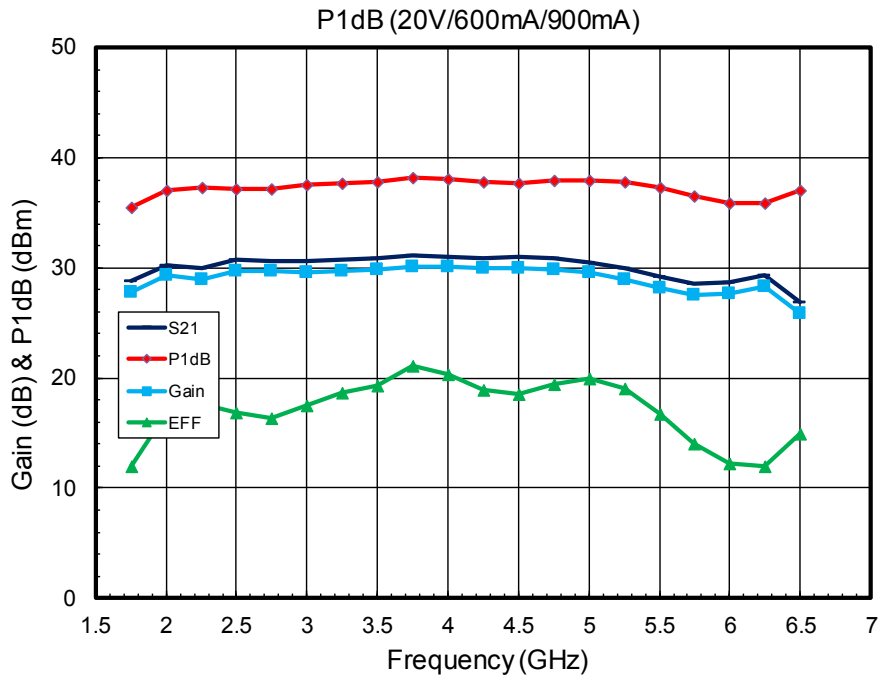

Vds= +15V

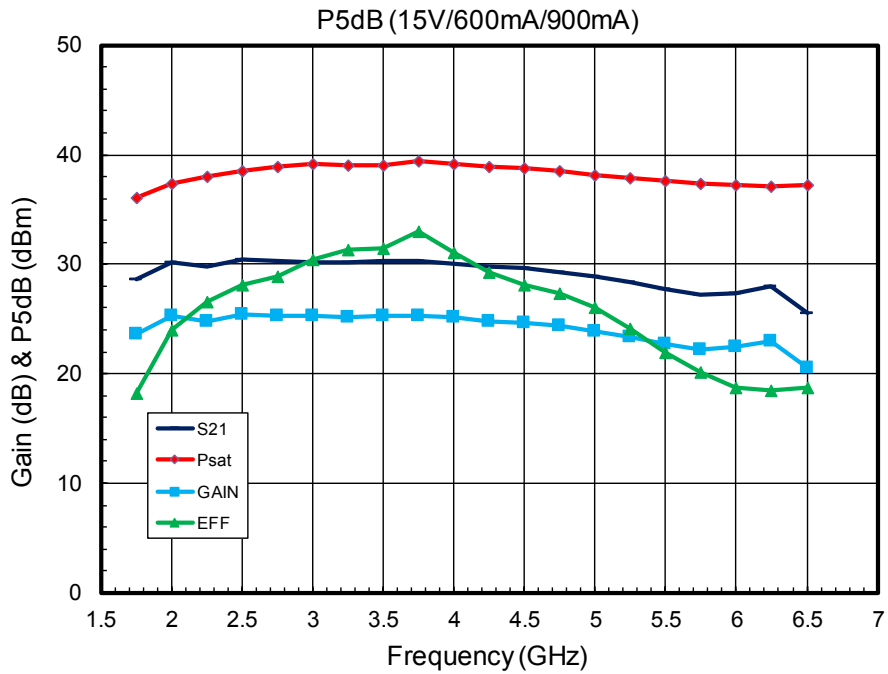
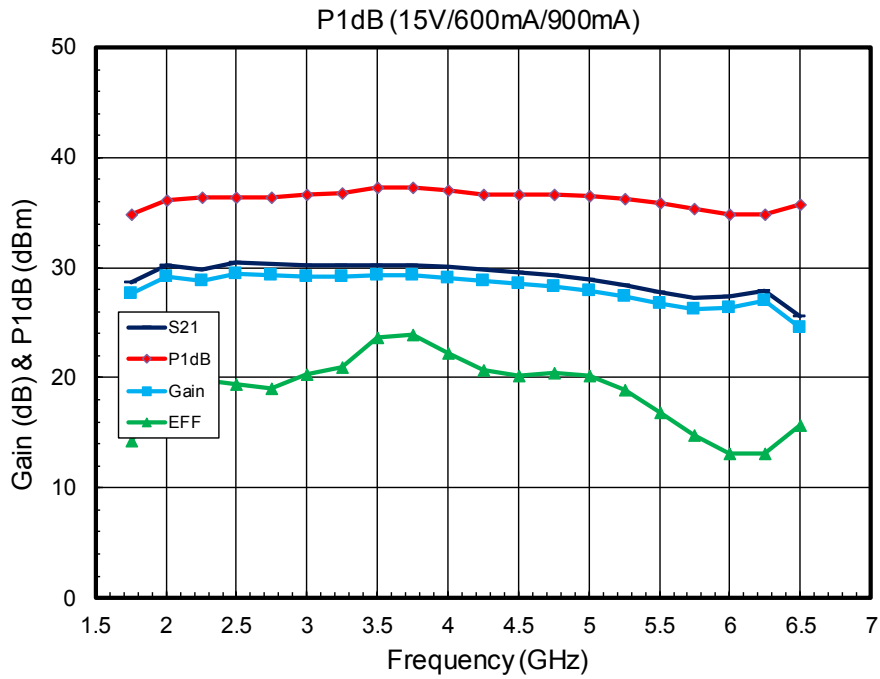

Vds= +12V

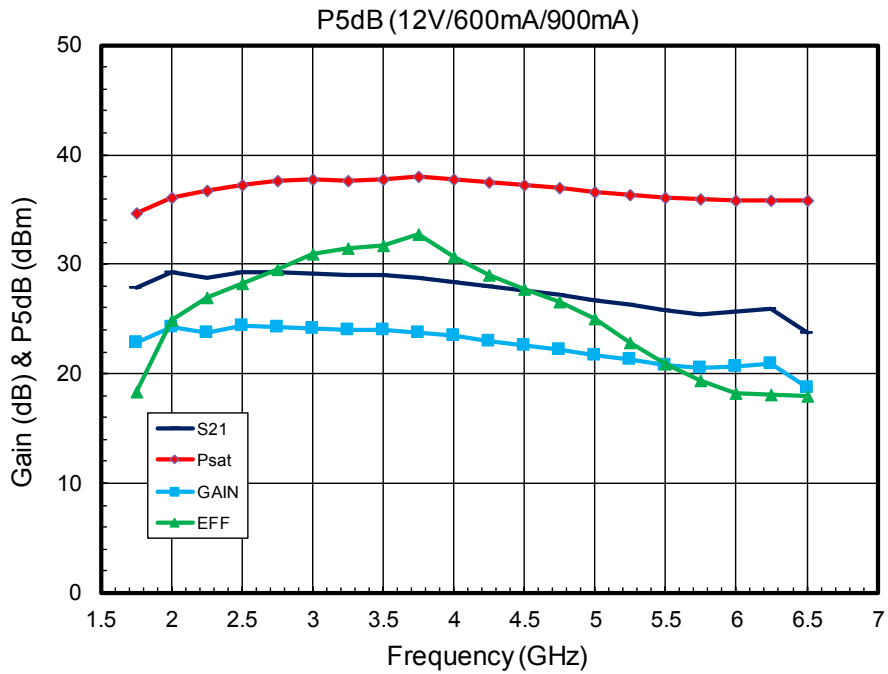
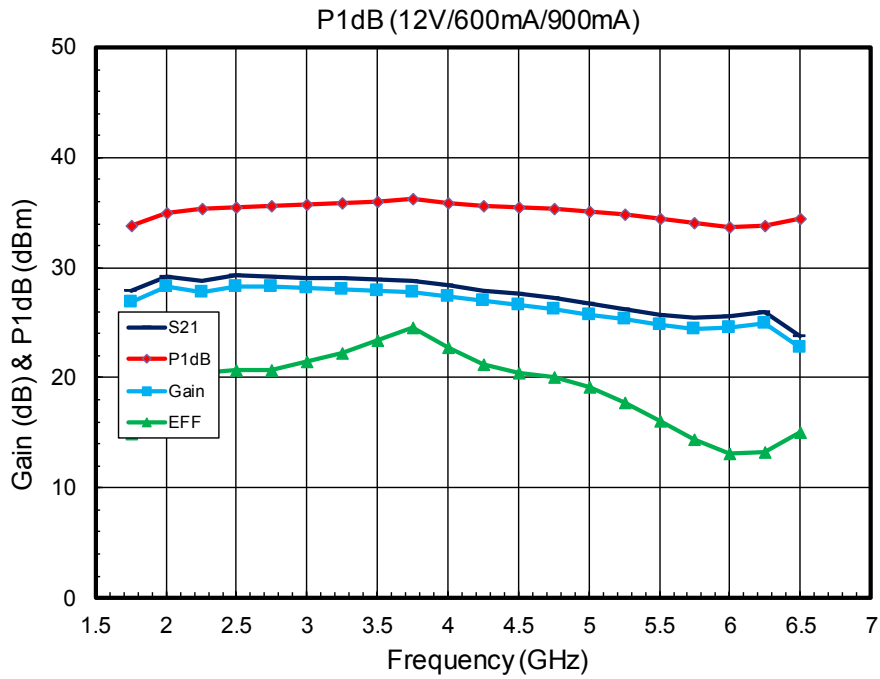

INTERMODULATION DISTORTION

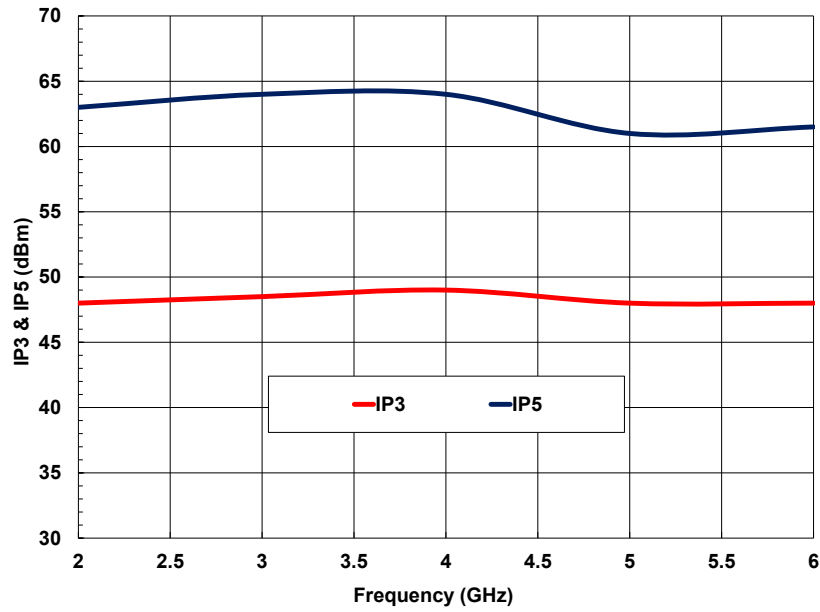

NOISE FIGURE

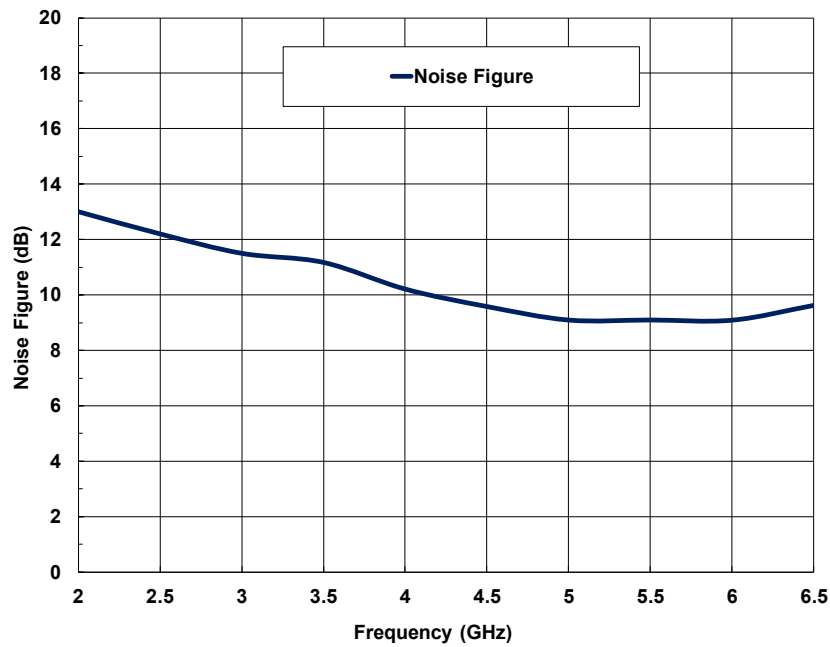

PACKAGE OUTLINE (AM206041WN-SN-R)

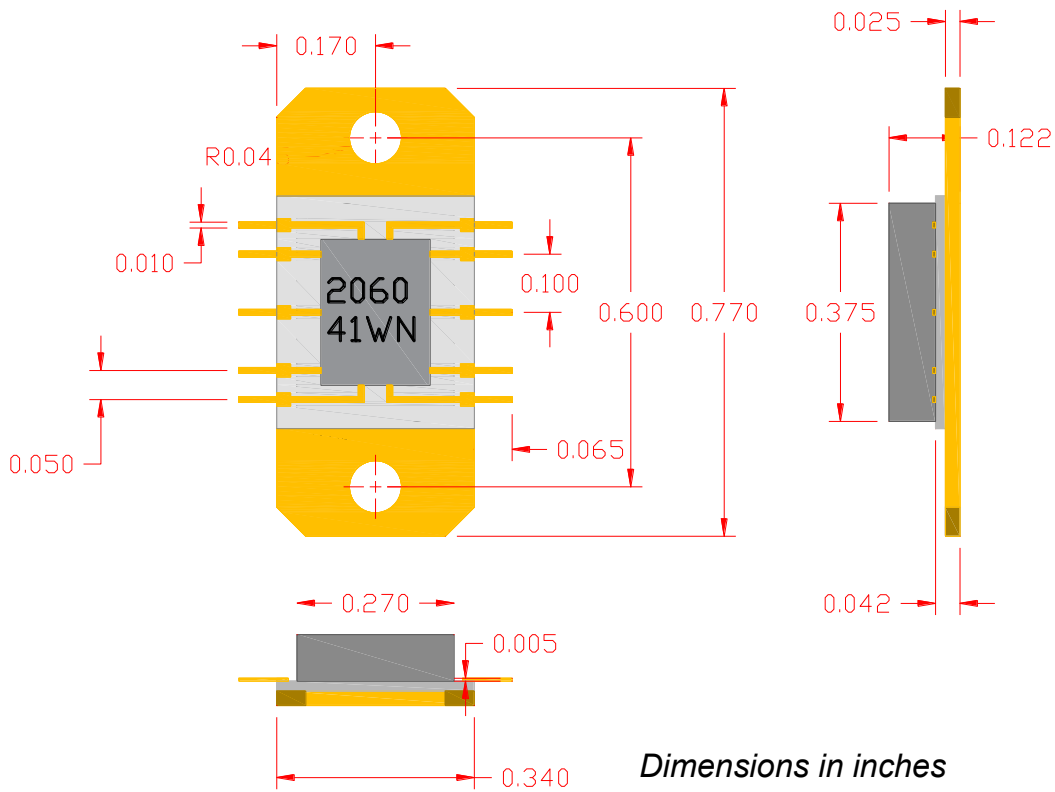

Pin Layout

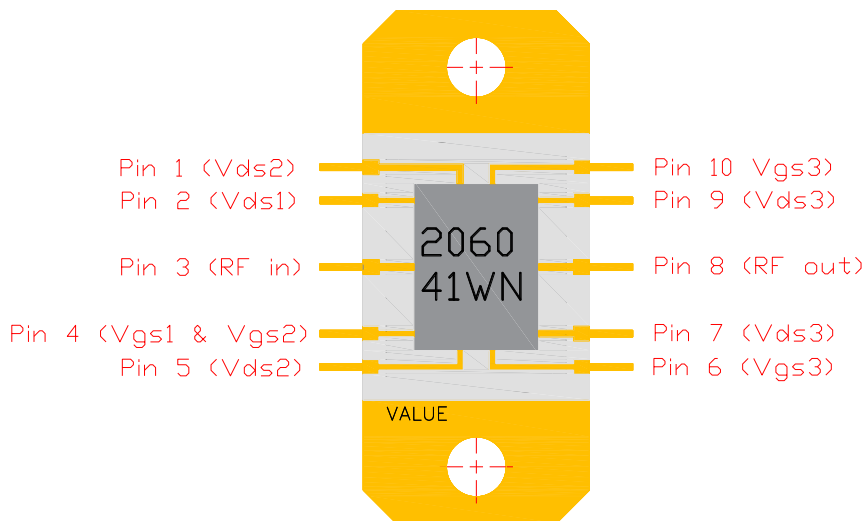

Pin No.	Function	Bias
1	Vds2	+28V
2	Vds1	+28V
3	RF in	-
4	Vgs1 & Vgs2	-2.3V
5	Vds2	+28V
6	Vgs3	-2.3V
7	Vds3	+28V
8	RF out	-
9	Vds3	+28V
10	Vgs3	-2.3V

TEST CIRCUIT

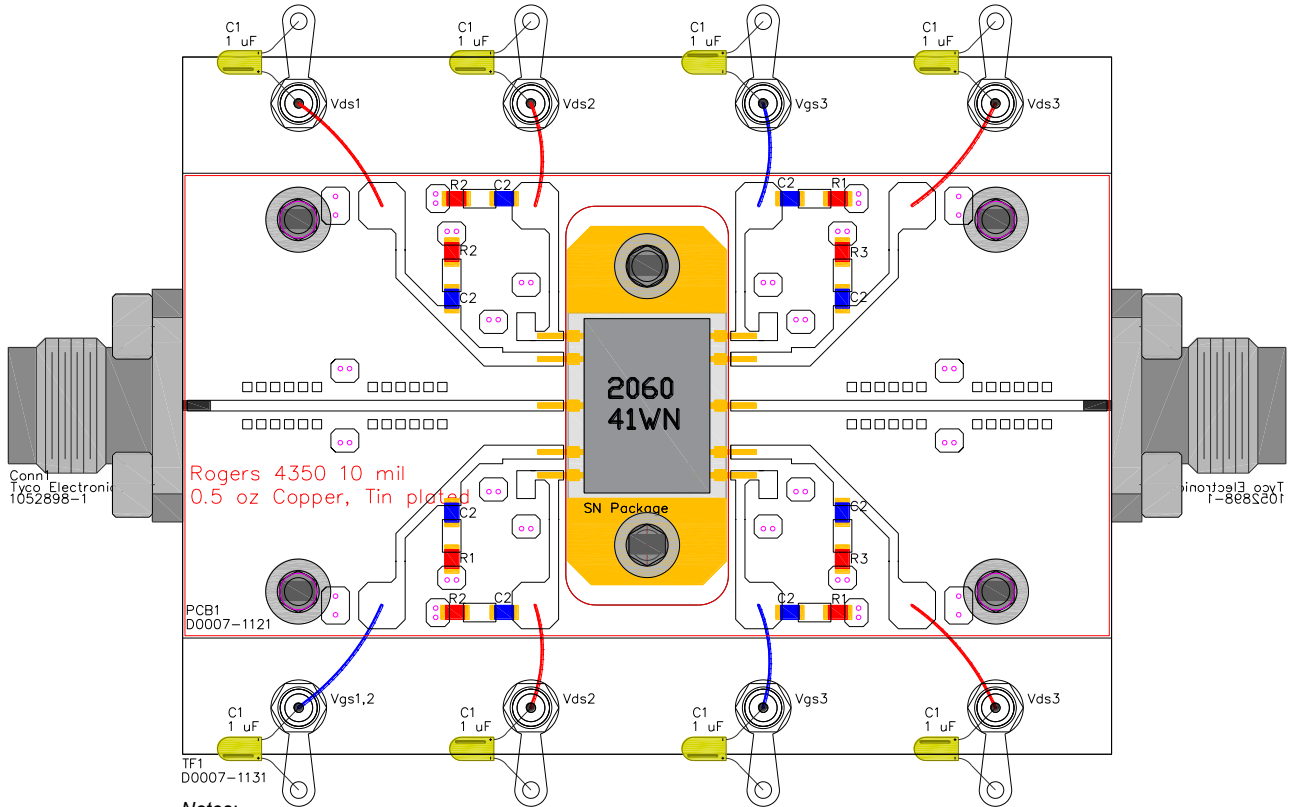

Notes:

- 1- Use epoxy to mount PCB
- 2- C1=1uF, C2=1000pF, R1=50ohms, R2=10ohms, R3=5ohms
- 3- All SMT Caps & Resistors are 0603 size
- 4- Use Test Block No. D0007-1131

Important Notes:

- 1- For best RF performance we recommend using 4mil indium shim between MMIC package and heatsink
- 2- Recommended current biases are 600mA for the first & second stage and 900mA for the third stage. Gate biases of -2.0V are for reference only. V_{gs1} & V_{gs2} could be adjusted to vary the currents going thru the first stage (V_{ds1} pin) & second stage (V_{ds2} pin). V_{gs3} could be adjusted to vary the currents going the third stage thru the two V_{ds3} pins.
- 3- Do not apply V_{ds1} , V_{ds2} & V_{ds3} without proper negative voltages on V_{gs1} , V_{gs2} & V_{gs3} . Otherwise MMIC would fail due to excess heat.
- 4- AutoCAD DXF available.