



WWW.Arcaudio.com

KS 300.2 KS 300.4 KS 600.2 CLASS H FULLRANGE STEREO AMPLIFIER

High Performance Audio Amplifier



OWNER'S MANUAL

ARC AUDIO WARRANTY AND SERVICE GUIDELINES

ARC AUDIO warrants all new KAR Series Amplifiers against defects in material and workmanship for a period of **ONE (1) YEAR** from the original date of purchase on all over the counter purchases not installed by an **AUTHORIZED ARC AUDIO RETAILER**. This warranty is extended to **Three (3) YEARS** if the product is originally installed by an **AUTHORIZED ARC AUDIO RETAILER** and is accompanied by a valid copy of the original receipt showing a charge for the installation. This warranty is not transferable and applies only to the **original retail purchaser** of the product from an authorized ARC AUDIO retailer. Upon inspection by ARC AUDIO should services be necessary under this warranty for any reason due to manufacture defects ARC AUDIO will, at its sole discretion, repair or replace the defective product with new or similar conditioned product at no charge.

THIS WARRANTY DOES NOT COVER INSTALLATION OR DAMAGE RESULTING FROM ACCIDENT, MISUSE, ABUSE, IMPROPER WIRING, OPERATION OUTSIDE OF THE MANUFACTURERS RECOMMENDATIONS OR SPECIFICATIONS, OR AGAINST INSTRUCTIONS IN OWNERS MANUAL. IN ADDITION ANY PRODUCT THAT HAS BEEN OPENED, TEMPERED WITH OR MODIFIED, OR IF ANY SERIAL NUMBERS HAVE BEEN REMOVED WILL NOT BE COVERED BY ANY PART OF THE MANUFACTURERS WARRANTY.

All warranty returns should be sent to ARC AUDIO freight prepaid and must be accompanied by proof of purchase (a copy of the original sales receipt). Direct returns from consumers or non-authorized retailers will be refused unless specifically authorized by ARC AUDIO with a valid return authorization number.

All warranty returns should be packed in original packaging and must be accompanied by a copy of the original sales receipt. Product damaged in shipment will not be covered under this warranty. The customer or retailer may choose to have this damage repaired at the normal "Out of Warranty" repair cost.

In no event will ARC AUDIO be liable for incidental, consequential, or other damages resulting from the use of this product, this includes but is not limited to, damage of hearing, property or person, damage based upon inconvenience or on loss of use of the product, and to the extent permitted by law, damages for personal injury. This warranty gives you specific legal rights, and you may have other rights, which vary from state to state. This warranty applies to products sold and used in the United States of America. In all other countries please contact your distributor

For warranty and non-warranty repairs, send to:

**ARC Audio
4719 Green Leaf Cr. #4
Modesto CA, 95356
209-543-8706**



Thank you for purchasing an ARC Audio Hi-Performance Amplifier.

This ARC Audio amplifier uses a Full Range Class H architecture that significantly improves efficiently without compromise to the sound quality. Don't be fooled by the small size. Class H amplifiers make more power for there size then traditional designs and offer much lower THD and higher Damping factors then Full Range Class D designs.

ARC Audio...**SOLID CONSTRUCTION for SOUND Car Audio Systems.**

Warning

We build all ARC Audio products to play at high volumes for extended periods of time. Your ears however are not designed for high volume listening. This product can easily generate volumes that can permanently damage your hearing. We urge you to limit your exposure to very high volume sound. You may also find your state has laws governing the volume of an audio system in a car. Please be aware of all local and state laws in you area. A properly tuned and operated audio system will deliver years of enjoyment when used properly.

Installation Instructions

ARC Audio KAR Series Amplifiers are designed for easy installation in your vehicle. To ensure proper operation of your new purchase, please follow the suggestions we have listed below:

Warning

Please check the suitability of the installation location before you begin. Do not cut any of the car's structure. Pay close attention to what is behind the panels or carpet. Often the manufacture will hide wires, computers or other electronic devices in the exact areas you wish to install in.

If you do not have experience with automotive electrical and mechanical systems contact a professional installer. Paying a qualified installer is almost always cheaper then paying a dealership to repair your car.

Locating the Amplifier

The amplifiers must be securely mounted to a solid surface. Please select a dry location in the trunk or passenger compartment only. Do not mount the amplifier to any area that may have excessive vibration (like the subwoofer box). Position the amplifier in an area that receives sufficient airflow for proper heat dissipation.

Supplying Enough Power

The Laws of Nature

Your amplifier Does NOT make power. It converts power, or current, from your cars electrical system and turns it into a high power musical energy. If the amp can't get all the power it needs it will not produce its full output. Your ARC Audio amplifier will produce Full output for longer then other amps on the market today. If the Voltage or Current drops too low even our amplifiers will drop below their rated output. Make sure your vehicle charging system is in good working order. Any Hi-Performance audio amplifier will increase the demand on your alternator and battery. If you are unsure have your charging system tested by a professional technician.

The Ground!!!

Warning: Read this Carefully

The ground wire should be connected directly to the chassis of your vehicle. Find a clear location close to the amplifier and remove all the paint and sound deadener. Use a #10 or larger screw to secure it. Never use seatbelt bolts for grounding. Remember, the ground must carry the same high current as the positive power wire.

To reduce the risk of noise, run all signal cables away from any vehicle or power supply wiring.

Running the Cables

Carefully run the power and signal cables through the passenger compartment of the vehicle. Always use a rubber grommet to prevent the power wire from shorting and to reduce the risk of fire. A 4 gauge or larger wire should be used for power and ground connections. We recommend a fuse be installed on the power wire within 18 inches of the battery for safety.

Setting the Gains

So you're worried that your 8 Volt output head unit will be too much for the ARC Audio's 4 Volt input stage.

Don't Be

ARC Audio Amplifiers input stage is rated to 4 volts RMS @ 1KHz without clipping.

Music is very dynamic. Nothing like a 1KHz test tone. It would be rare to see a peak as high as a test tone. Furthermore, your head unit produces its output at full volume but when you tune your system you always set the head unit to 70% of maximum volume.

Input Section

Because of the wide range of head unit output configurations all ARC Audio amplifiers have an adjustable input sensitivity or "Gain". The gain is not a volume or a power limiting control like a throttle. It makes the amp more sensitive to input from the stereo. With the gain up the amp will reach full output at a lower volume setting on the deck. At higher gain settings the amp also becomes more sensitive to noise from the car's electrical system. Try to run the gain at the lowest setting possible for you system.

There is no correct gain setting. Because speakers require different power demands to reach the same output, the gains most often need to be used to compensate for these differences. If you tried to set all the gains at half way you would probably find the system didn't sound very good. Using good judgment and listening carefully to each speaker is still the best way to tune a system.

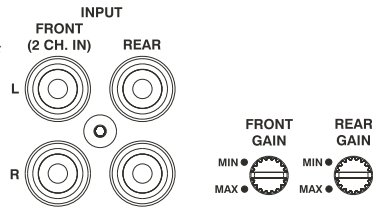

Input Mode Switch

All ARC Audio amplifiers include an input mode switch. This switch controls the signal being sent to the amplifier sections. Most 2-channel amplifiers can be bridged into a single channel however if the signal to the channels is not exactly the same the distortion will increase significantly. The mode switch solves this problem by offering 3 modes of operation.

Stereo

This is simple 2 channel stereo operation. Use this setting for most applications that do not involve bridging the output.

Bridge (R IN)

On a 2-channel amp only the Right channel input will be split and sent to both outputs. On a 4 channel the Right RCA Front will be sent to the front outputs. The Left Front RCA will be sent to the rear outputs. This is a great way of get high power to a component set. The amplifier now acts like a 2 channel that makes full power at 4 ohms.

L+R SUM MONO

This is the mode for bridging a subwoofer. Both the left and right channels are combined into a mono signal that is then split and sent to both output. This will give you a true mono output.

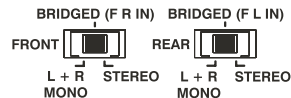

Crossover Controls

A crossover is a device that removes unwanted frequencies from a speaker or amplifier. A tweeter can easily be destroyed by bass notes if they are not filtered out. Likewise a subwoofer will not sound natural if it is playing midrange notes. A crossover removes these sounds from the speaker. As you might guess, careful adjustment is need to ensure that all the speakers are playing the right sounds and that you are left with no "holes" or low spots in the frequency response.

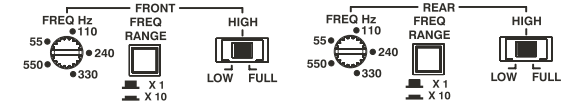

Bass Boost

This amp has an adjustable bass boost. On the 4 channel KS 300.4, the Input Source Select has 3 options. In "4 CH." or "2 CH" the Bass Boost will be directed to the front speakers. In "2 CH.BB" The Bass Boost will be sent to all 4 channel equally. Begin your adjustments at low volume. If you do not hear any improvement then the woofer does not need any boost.

Use Bass Boost carefully. The demands on power output are tremendous. Try to minimize the use by changing woofer position or the enclosure size.

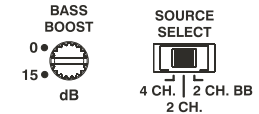

AUTO SENSE

The KS 600.2 uses a Patent Pending Auto Sense Turn-on circuit that offers a significant improvement in reliability over previous designs. Instead of relaying on the music to supply enough signal to turn the amplifier on. Robert Zeff's new design detects the IC (chip) used in the vast majority of stock head units and amplifiers.

When using the auto sense feature the remote input on the power strip becomes a remote output reversing the remote turn-on connection to turn on the rest of your amplifiers?

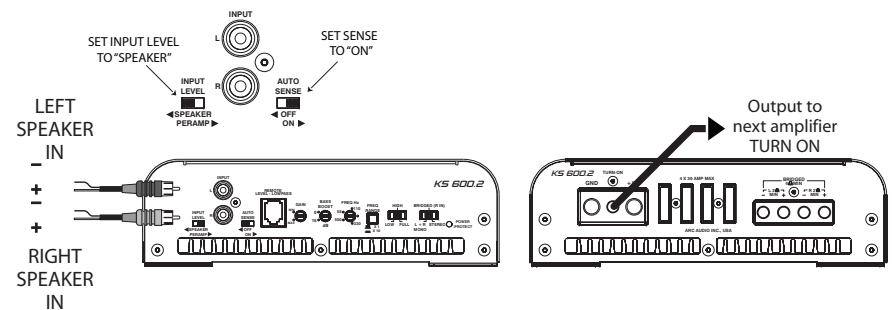

Installation Instructions

1. Disconnect the negative cable from the car battery. Tape up the end so it is isolated from the battery.
2. Run an 4 AWG wire from the battery to the amplifier. Plan this part of the installation carefully. This cable will carry very high current. If it should short to the body and it is not properly fused it could catch fire.
3. Connect the power wire to the battery using a fuse capable of the total current load of all amplifiers connected. Don't install the fuse yet. Wait until the end. Locate the fuse as close as possible to the battery. If the fuse is further than 18 inches (wire length) from the battery you should reevaluate the wire and fuse placement.
4. Find the closest clear metal area to the amp for a ground. Sand, grind or scrape all paint and undercoating from the body and screw the ground securely to the body.

It is advisable to test the ground with an ohmmeter between the ground cable and the negative battery cable to insure a good low resistance connection. Some alloys used in modern cars do not offer the best ground. If you believe this is the case consult with the vehicle manufacturer.

5. Run the speaker wire to the speakers. It is advised that you leave some extra wire at this point. You can "clean it up" later.
6. If you haven't already done so, mount the amp now.
7. Connect the power and ground to the amplifier.

Only after this step should you install the fuse at the battery.

8. Connect the remote wire from the head unit to the amplifier. Now is a good time to turn on the amp for the first time. Make sure it turns on properly and does not go into protection.

9. Connect the speaker wires to the amp and speakers (make sure the amp is off first). Make sure the polarity (+ and-) is correct.
10. Connect the RCA's to the amp.
11. Double check the amplifier controls at this time. Make sure everything is set correctly for your system.
12. Now you're ready to play it for the first time. It is best to leave the gain all the way down at first. Start with the head unit volume low and work your way up.
13. Now you can tune the amp. Take your time and make only one adjustment at a time. It may take some time to get the system fully adjusted. During this time the amp is drawing current from the battery. You should check the battery voltage from time to time and re-charge it if it gets low. Battery voltage can affect the way the amplifier performs.
14. You're done. Now have fun.

This amplifier is equipped with an advanced diagnostic system controlled by the microprocessor. In the event that this unit goes into protection for any reason it will flash the status light found on the control end of the amplifier. The different sequences indicate the "Code" for faster trouble shooting.

BLUE FLASHING

CODE 11 Red Green Flashing

CODE 12 1 Flash, Pause, 2 Flashes

CODE 13 1 Flash, Pause, 3 Flashes

CODE 14 1 Flash, Pause, 4 Flashes

NORMAL TURN ON

THERMAL PROTECTION (Turn the volume down and wait for the amplifier to cool)

SHORT (Turn the amplifier off and check for a shorted speaker or wire.)

REPEATED SHORT (Correct the short and leave the amp off for 5 minutes.)

OVERVOLT (This is a charging system failure. DO NOT START THE ENGINE.)

**KS 300.2 / KS 600.2
BRIDGED 4 OHMS
2 OHM NOT RECOMMENDED**

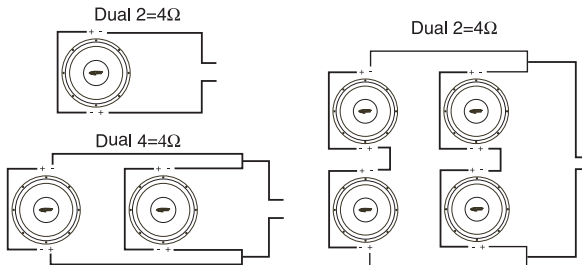
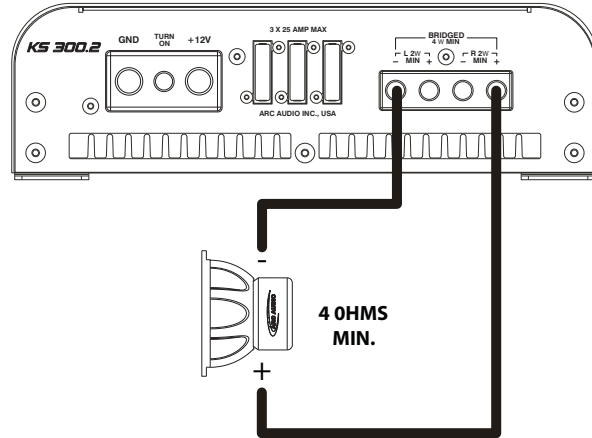
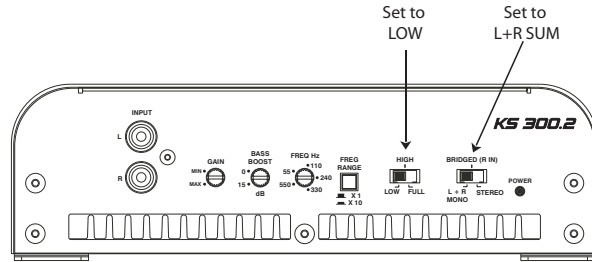

**KS 300.2 / KS 600.4
STEREO FULLRANGE OR HIGH PASS
2 OR 4 OHMS**

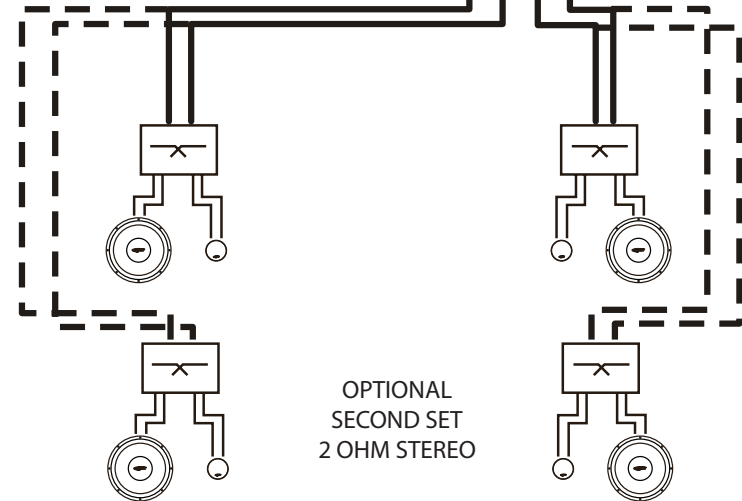
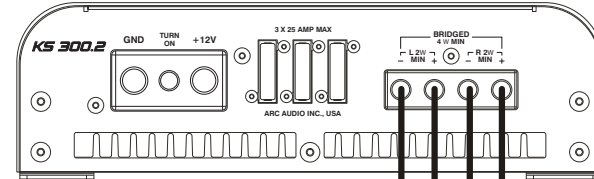
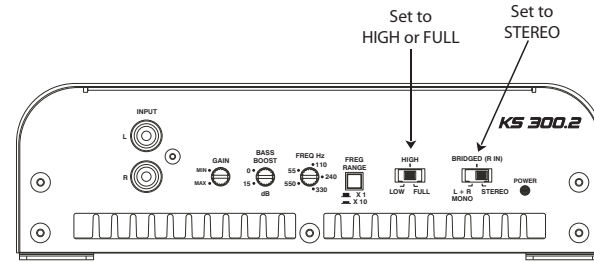

**KS 3004
STEREO 4 CHANNEL
HIGH PASS**

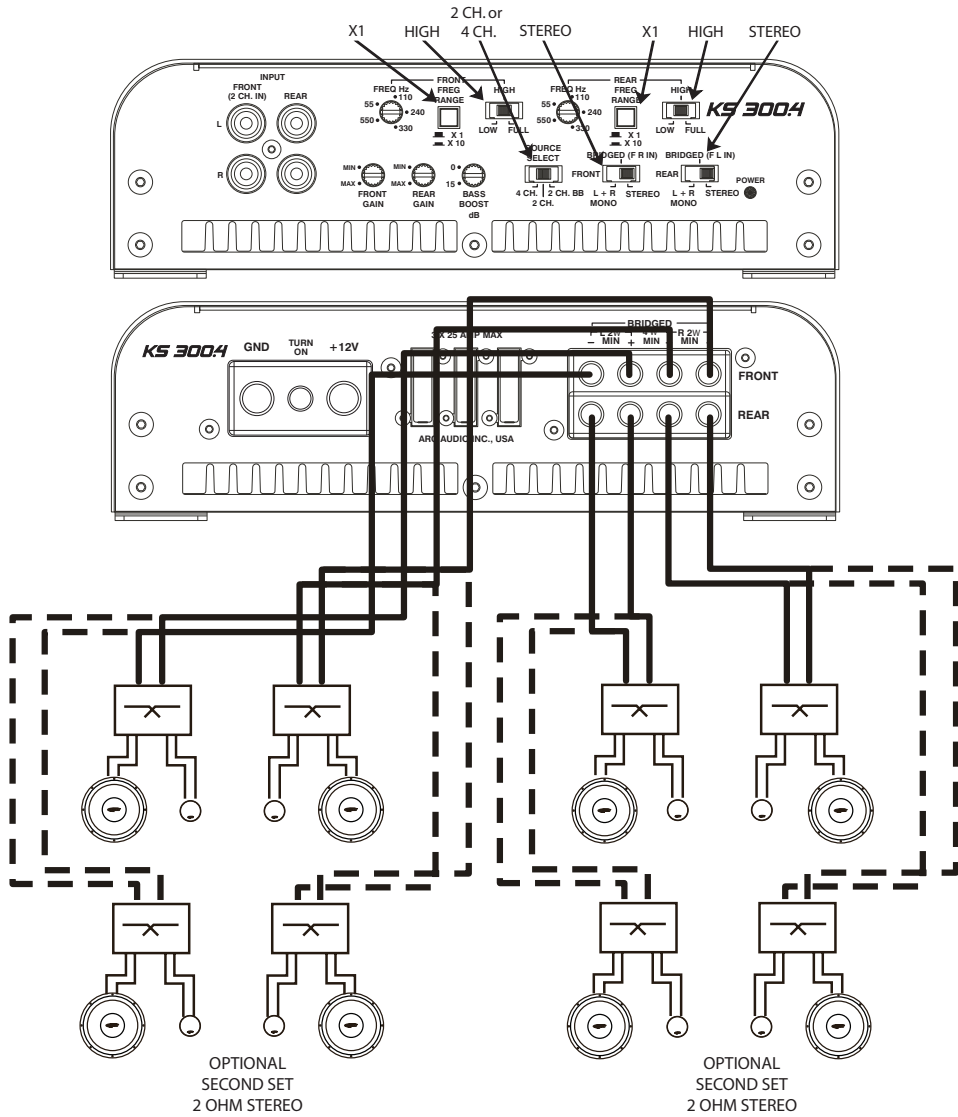

**KS 3004
STEREO HIGH PASS
With MONO SUBWOOFER**

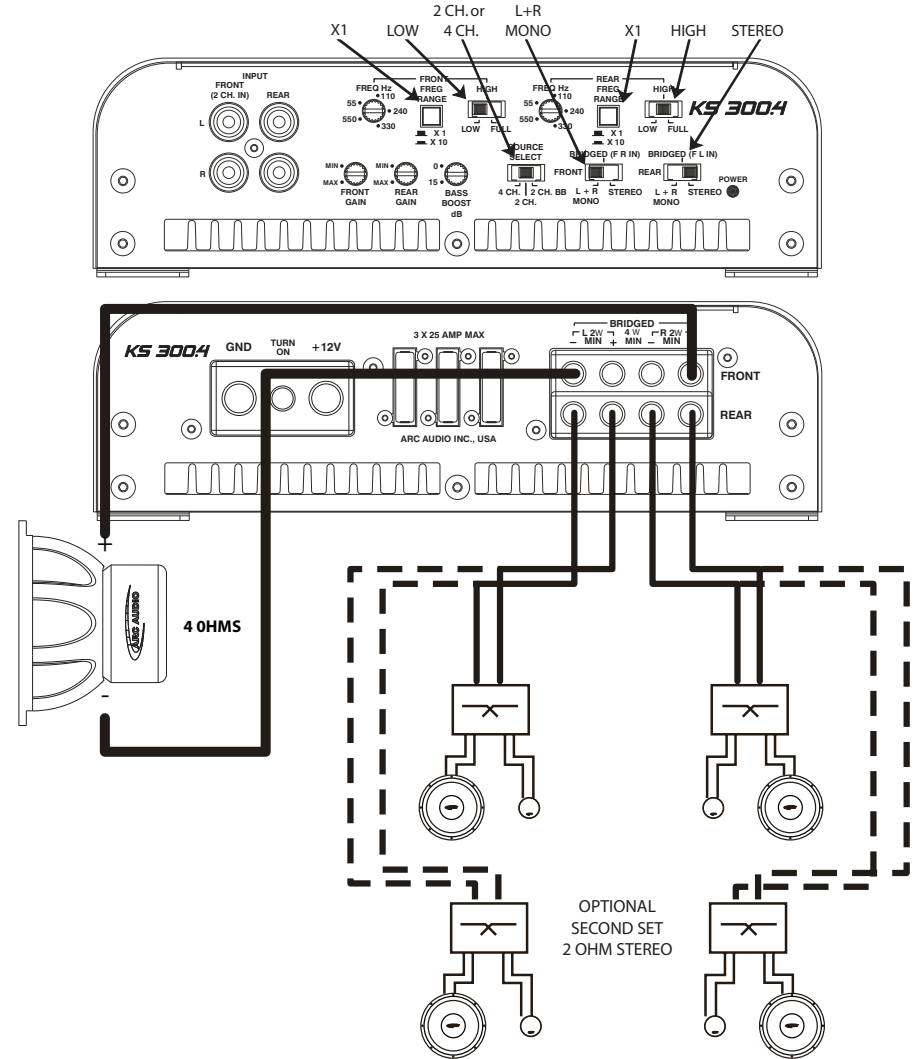

KS 3004 2 CHANNEL BRIDGED STEREO HIGH PASS

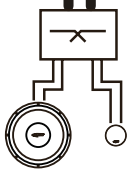
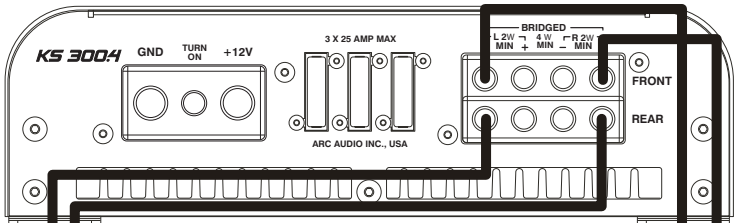
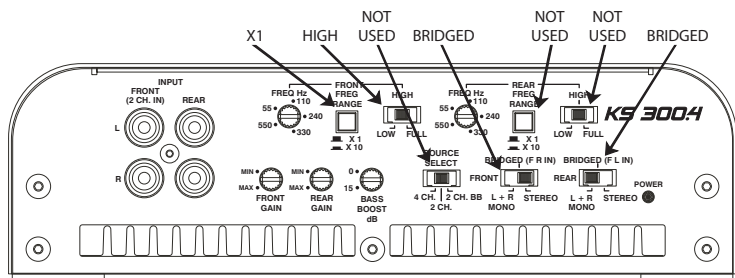

USE 4 OHM SPEAKERS ONLY
WARNING: THE KS 300.4 WILL
PRODUCE OVER 700 WATTS
IN THIS CONFIGURATION
ARC AUDIO IS NOT
RESPONSIBLE FOR
DAMAGED SPEAKERS

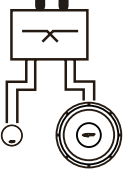

KS 3004 2 CHANNEL BRIDGED STEREO LOW PASS

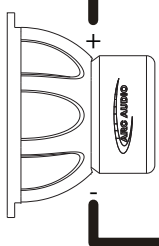
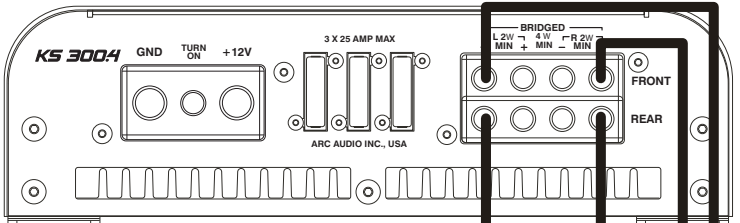
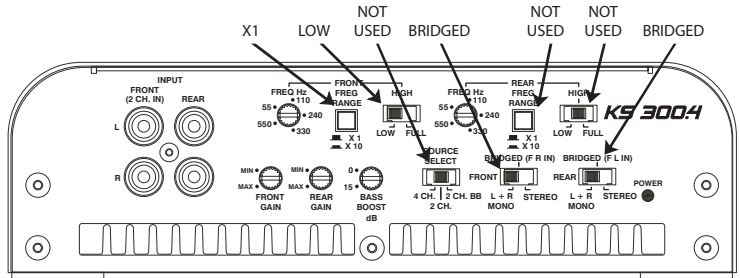

4 OHMS

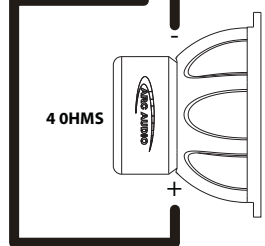

4 OHMS

POWER AND INPUT CONNECTIONS SINGLE BATTERY

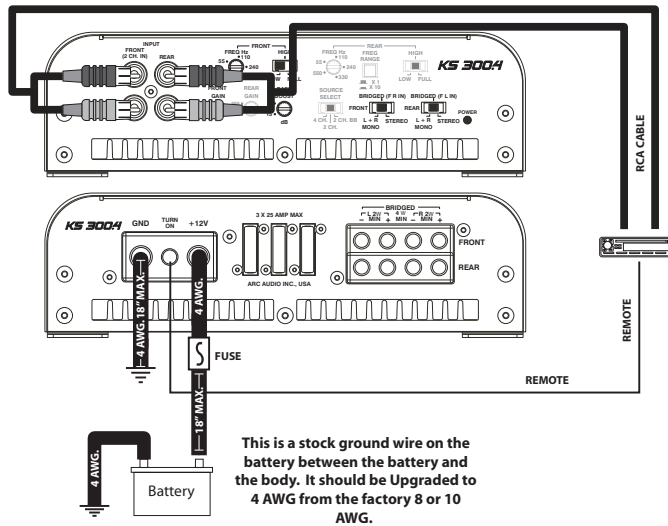

POWER AND INPUT CONNECTIONS DUAL BATTERY or BATTERY AND CAPACITOR

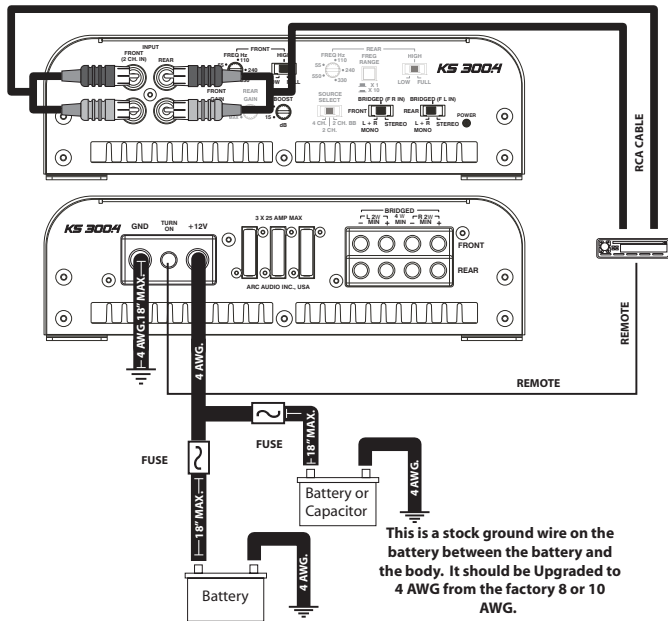

SPECIFICATIONS

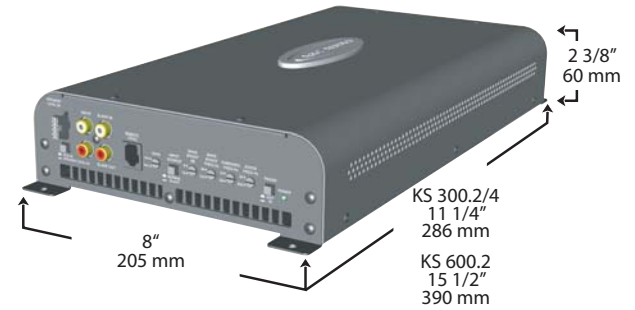

OUTPUT POWER (RMS) @1% THD 100HZ 14.4VDC			
	KS 300.2	KS 600.2	KS 300.4
POWER OUTPUT @ 4 Ω	180 X 2 WATTS	400 X 2 WATTS	90 X 4 WATTS
POWER OUTPUT @ 2 Ω	350 X 2 WATTS	600 X 2 WATTS	175 X 4 WATTS
POWER OUTPUT @ 1 Ω	NOT RECOMMENDED	NOT RECOMMENDED	NOT RECOMMENDED
POWER OUTPUT @ 4Ω BRIDGED	700 WATTS	1200 WATTS	350 X 2 WATTS
POWER OUTPUT @ 2 Ω BRIDGED	NOT RECOMMENDED	NOT RECOMMENDED	NOT RECOMMENDED
TOTAL HARMONIC DISTORTION	.01%	.01%	.01%
FREQUENCY RANGE -3dB	7Hz-68KHz	7Hz-68KHz	7Hz-68KHz
CROSSOVER RANGE	55Hz-5.5KHz	55Hz-5.5KHz	55Hz-5.5KHz
BASS BOOST	0-15dB @ 45Hz	0-15dB @ 45Hz	0-15dB @ 45Hz
S/N RATIO (A wtg) ref 1 Watt 4 ohms	>95dB	>96dB	>98dB
SEPARATION	78dB	78dB	76dB
DAMPING FACTOR 25W out 4 ohm 100Hz	>800	>800	>800
INPUT SENSITIVITY (RCA)	.25V-4.0V	.25V-4.0V	.25V-4.0V
INPUT IMPEDANCE	13K OHMS	13K OHMS	13K OHMS