A collection of surgical instruments, including forceps, a scalpel, and a probe, are arranged on a dark blue, textured surface. The instruments are rendered in a semi-transparent, blue-tinted style, creating a sense of depth and precision. The background has a fine, repeating pattern of small dots.

1U

JUST
ONE
USE

by  Surgitrac[®]
Europe

OPHTHALMOLOGY . OPHTALMOLOGIE . OPHTHALMOLOGIE



We are an established manufacturer and distributor of single-use ophthalmic surgical instruments, and procedure packs.

We sell our products using a global network, of authorised distributors.

We offer :

- Quality assured, CE marked products, manufactured to internationally recognised standards.
- ISO 13485:2016 certified manufacturing.
- Transparency in our supply chain : no forced, or child labour is used during our manufacturing.
- A continuous supply of products, due to our capacity to manufacture millions of instruments each year.
- Private label manufacturing.
- Over 10 years' experience in the manufacture of surgical instruments.
- Customer support.

www.surgitrac.com





Nous sommes distributeur d'instruments chirurgicaux ophthalmiques à usage unique, et de packs de procédures.

Nous vendons nos produits en utilisant un réseau mondial de distributeurs agréés.

Nous offrons :

- Qualité garantie, produits marqués CE, fabriqués selon des normes internationalement reconnues.
- Fabrication certifiée ISO 13485:2016.
- Transparence dans notre chaîne d'approvisionnement : aucun travail forcé ou effectué par des enfants n'est utilisé lors de notre fabrication.
- Un approvisionnement continu de produits, grâce à notre capacité à fabriquer des millions d'instruments chaque année.
- Fabrication de marques privées.
- Plus de 10 ans d'expérience dans la fabrication d'instruments chirurgicaux.
- Support client.

www.just-one-use.com

Wir sind ein etablierter Hersteller und Vertrieb für ophthalmologische, chirurgische Instrumente und Packs.

Wir vertreiben unsere Produkte über unser globales Netzwerk ausgesuchter Distributoren.

Wir bieten :

- sichere Qualität, CE zertifiziert, hergestellt nach internationalen anerkannten Standards ISO 13485:2016 zertifizierte Herstellung.
- Transparente Lieferkette : Produktion ohne Ausbeutung oder Kinderarbeit
- Lieferfähigkeit der Produkte aufgrund Produktionsfähigkeit für Millionen von Produkten jedes Jahr
- Private Label Hersteller
- über 10 Jahre Erfahrung in der Herstellung von chirurgischen Instrumenten
- Kundenbetreuung ansässig

www.just-one-use.com

JUST ONE USE

PHACO, REFRACTIVE & CORNEA

 **SUMMARY** | SOMMAIRE
INHALTSVERZEICHNIS

1/ CAPSULORHEXIS

CAPSULORHEXIS
KAPSULORHEXIS

PAGES 06-07

2/ FORCEPS

PINCES
PINZETTEN

PAGES 08-17

3/ MANIPULATORS & CHOPPERS

MANIPULATEURS & CHOPPERS
MANIPULATOREN & CHOPPER

PAGES 18-23

4/ SPECULUMS

BLEPHAROSTATS
LIDSPERRER

PAGES 24-30

5/ SCISSORS

CISEAUX
SCHEREN

PAGES 31-36

6/ MEASURERS & MARKERS

MESUREURS & MARQUEURS
MESSINSTRUMENTE & MARKER

PAGES 37-39

7/ CURETTES & CLAMPS

CURETTES & PINCES
KÜRETTEN & KLEMMEN

PAGES 40-41

8/ NEEDLE HOLDERS

PORTE-AIGUILLES
NADELHALTER

PAGES 42-43

9/ LACRIMAL

LACRYMAL
LAKRIMAL

PAGES 44-46

10/ CORNEAL & REFRACTIVE

CORNÉE & RÉFRACTIVE
KORNEAL & REFRAKTIV

PAGES 47-54

11/ GENERAL OPHTHALMIC

OPHTALMOLOGIE GÉNÉRALE
ALLGEMEINE OPHTHALMOLOGIE

PAGES 55-59



Just One Use // *The acronym « Just One Use » affirms the single use characteristic of our instruments.* **Safety** : reduce the risk of cross-contamination. **Economy** : eliminate the costs of repair and sterilization. **Performance** : manufactured from medical grade stainless steel, our single use instruments have the same grip, weight and balance of reusable instruments. **Convenience** : reduce theatre preparation time, presentation in sets or individually.

CAPSULORHEXIS / capsulorhexis / kapsulorhexis

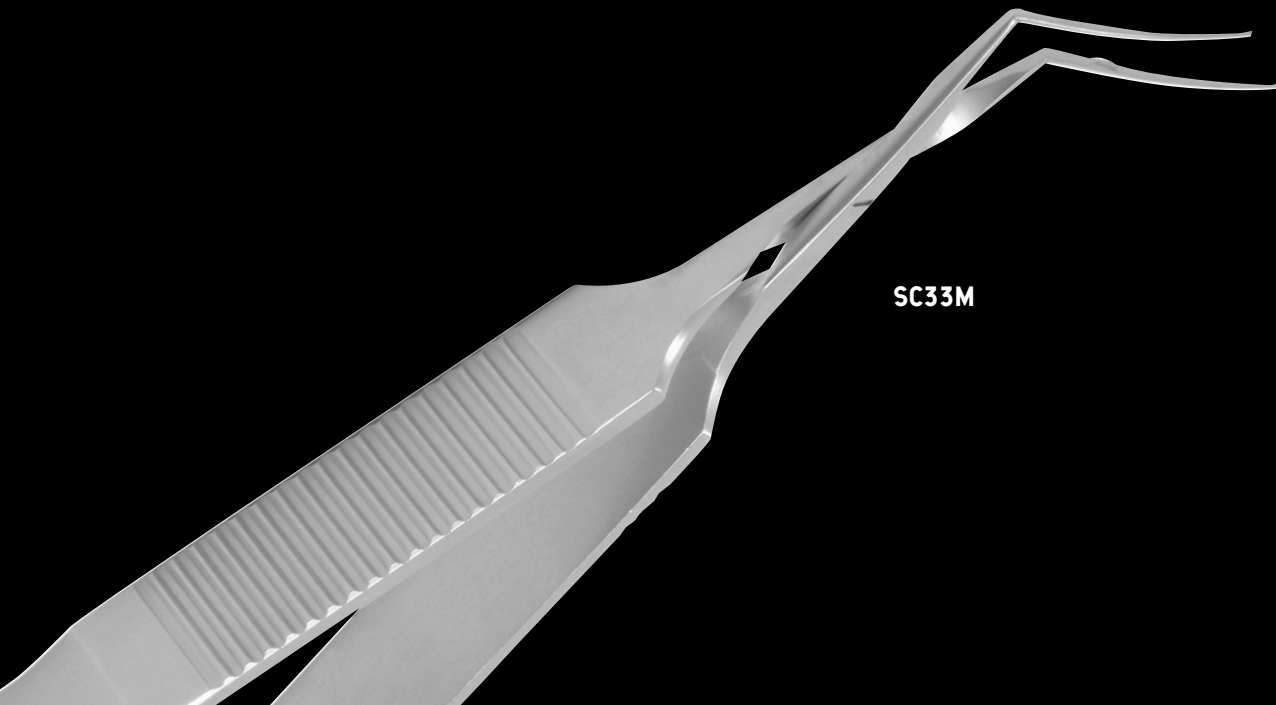

MICS CAPSULORHEXIS FORCEPS CROSS ACTION

Pince Capsulorhexis Action Croisée, Courbe
MICS Kapsulorhexispinzette Cross Action (x-Action)

Length : 11.5 cm
Handle length : 84 mm
50° angled
1.8 mm incision

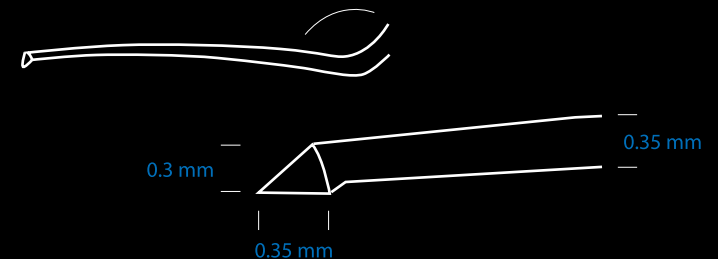

CAPSULORHEXIS ROUND BODIED CURVED / Pince Capsulorhexis, Manche Rond, Courbe / Kapsulorhexispinzette, gebogen, runder Griff

Length : 10.5 cm
Handle length : 77 mm
45° angled platform with notched tips 0.3 mm
1.8 mm incision

SC34M

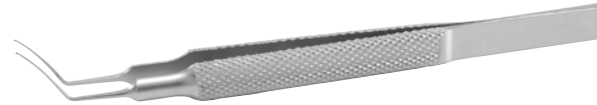

CAPSULORHEXIS

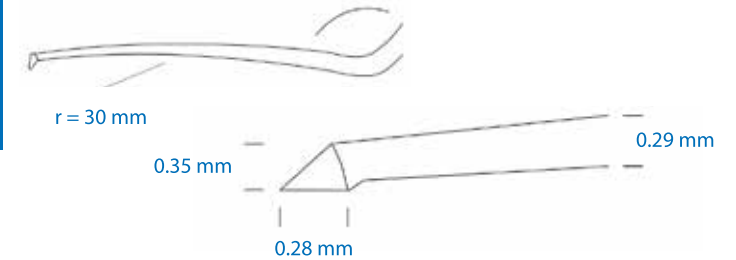

MICS CAPSULORHEXIS FORCEPS CURVED / Pince Capsulorhexis MICS, Courbe / MICS Kapsulorhexispinzette, gebogen

Length : 10.5 cm
Handle length : 77 cm
45° angle
12 mm platform
0.3 mm tips
1.8 mm incision

SC29M



CAPSULORHEXIS



MICS CAPSULORHEXIS FORCEPS ROUND BODIED CURVED / Pince Capsulorhexis, Manche rond / Kapsulorhexispinzette, runder Griff

Length : 10.5 cm
Handle length : 77 mm
50° angle 0.2 mm tip
12 mm platform
1.8 mm incision

SC134M



CAPSULORHEXIS

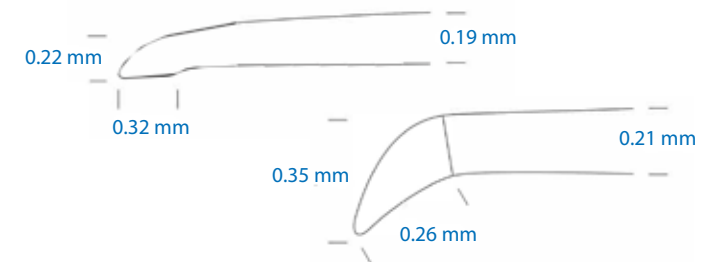

MICS CAPSULORHEXIS FORCEPS STRAIGHT / Pince Capsulorhexis MICS Droite, Kystitome / MICS Kapsulorhexispinzette, gerade

Length : 10.5 cm
Handle length : 76 mm
45° angled 0.3 mm notched tips, with 11 mm platform
1.8 mm incision

SC133M



CAPSULORHEXIS

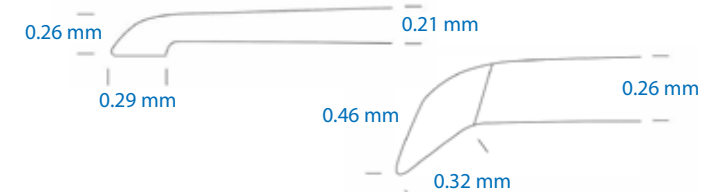

Just One Use // Le sigle « *Just One Use* » affirme le caractère usage unique de nos instruments. **Sécurité** : réduire le risque de contamination croisée. **Économie** : éliminer les coûts de réparation et de re-stérilisation. **Performance** : usinés en acier inoxydable de grade médical, nos instruments à usage unique offrent une ergonomie, un poids et un équilibre équivalents aux instruments re-stérilisables. **Praticité** : réduire le temps de préparation au bloc, présentation en sets ou à l'unité.

FORCEPS / Pincers / Pinzetten

 **FIXATION** | **GENERAL** | **LENS** | **TYING**



ADSONS DISSECTION FORCEPS / Pince d'Adson à Griffes / Adson Dissektionspinzette

Length : 12.5 cm
Handle length : 97 mm
1 into 2 teeth
28 mm platform



FIXATION

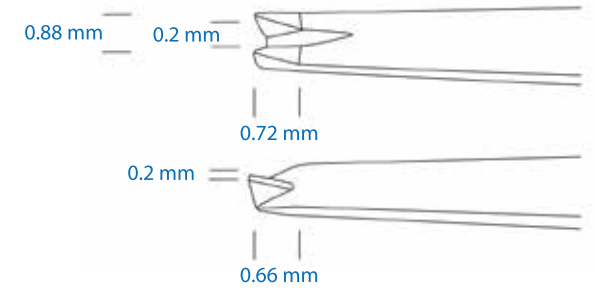

BISHOPS FORCEPS / Pince de Bishop / Bishops Pinzette

Length : 10.5 cm
Handle length : 75 mm
1 into 2 teeth
5 mm platform
30 mm tip



FIXATION

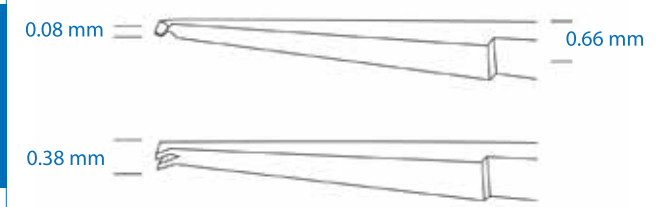

BONN FORCEPS / Pince de Bonn, à Griffes, Manche court / Irispinzette, Bonn, kurzer Griff

Length : 85 mm
Handle length : 57 mm
1 into 2 teeth
Short handle
5 mm platform

SC38



FIXATION

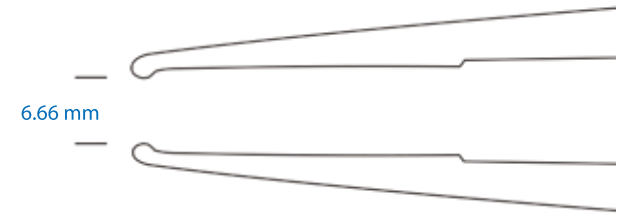

BONN FORCEPS / Pince de Bonn, à Griffes, Manche long / Irispinzette, Bonn, langer Griff

Length : 10.5 cm
Handle length : 76 mm
1 into 2 teeth
5 mm platform

SC129



FIXATION

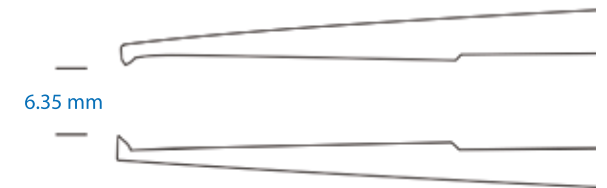

COLIBRI TOOTHED FORCEPS / Pince Colibri, à Griffes, Manche long / Kolibri Pinzette, gezahnt, langer Griff

Length : 11 cm
Handle length : 72 mm
55° angled
1 into 2 teeth
4 mm platform

SC22



FIXATION

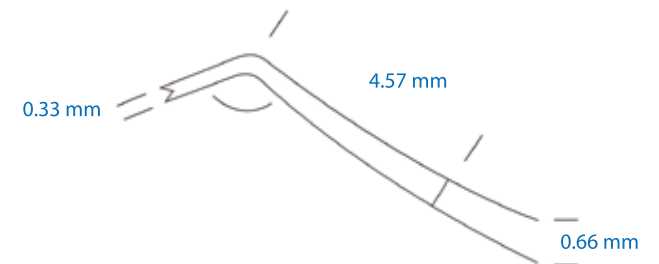

COLIBRI TYING FORCEPS / Pince Colibri, à Griffes, Manche court / Kolibri Pinzette, gezahnt, kurzer Griff

Length : 85 mm
Handle length : 59 mm
55° angle forked tip
Short handle
4 mm platform

SC20



FIXATION

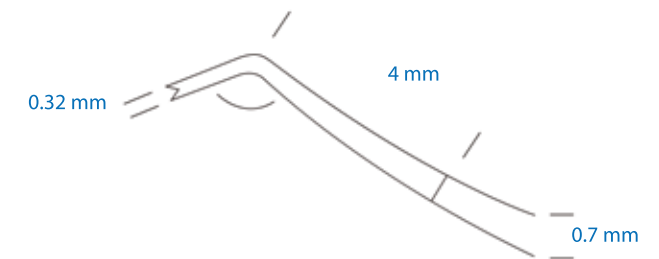

FINE CLAW FORCEPS / Pince à Griffes Fines / feine Greifpinzette

Length : 10 cm
Handle length : 68 mm
2 into 1 teeth
32 mm platform to tip

SC115



FIXATION

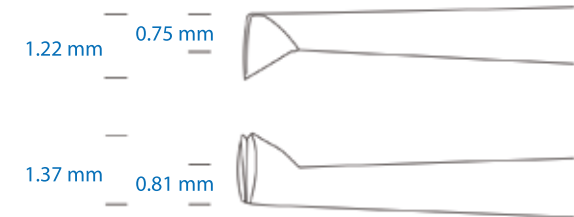

HOSKINS FORCEPS / Pince de Hoskins / Hoskins Pinzette

Length : 85 mm
Handle length : 56 mm
Notched forceps
5 mm platform

SC55



CAPSULORHEXIS



IRIS FORCEPS / Pinces à iris, griffes fines / Irispinzette, gezahnt, sehr fein

Length : 10.5 cm
Handle length : 67 mm
1 into 2 teeth
5 mm platform

SC116



FIXATION



IRIS FORCEPS POINTED / Pinces à iris, Extrémités pointues, Mors striés / Irispinzette, gerade, gerieft

Length : 11 cm
Handle length : 69 mm
Serrated 15 mm platform

SC128



FIXATION

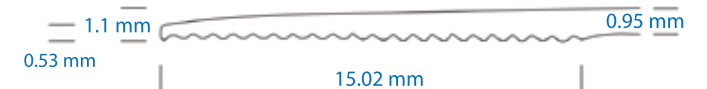

JAYLES FORCEPS / Pince de Jayles / Jayles Pinzette

Length : 10.5 cm
Handle length : 67 mm
1 into 2 teeth
5 mm platform

SC117



FIXATION

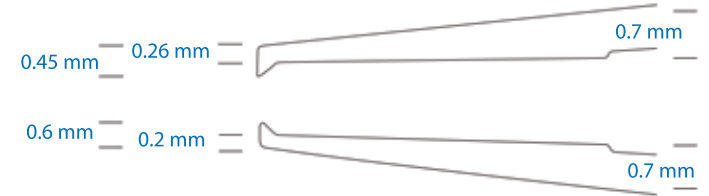

STRAIGHT NOTCHED FORCEPS (HOSKINS) / Pince à fixer alvéolée de Hoskins / Hoskins Pinzette gerade

Length : 11 cm
Handle length : 76 mm
Notched forceps
5 mm platform

SC49



FIXATION

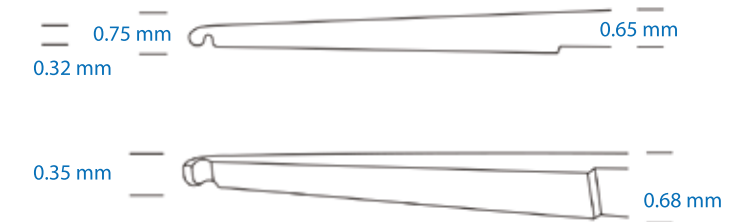

ST. MARTINS FORCEPS / Pince de Paufique / St. Martins Pinzette

Length : 84 mm
Handle length : 56 mm
1 into 2 teeth
6 mm platform

SC54



FIXATION

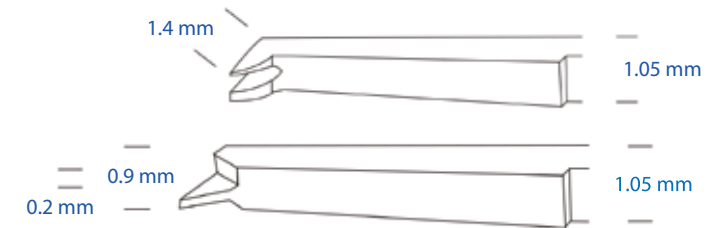

STRAIGHT TOOTHED FORCEPS FINE / Pince à Tissus, droite / Pinzette gerade, fein mit Zähnen

Length : 10.5 cm
Handle length : 78 mm
1 into 2 teeth
5 mm platform

SC21



FIXATION

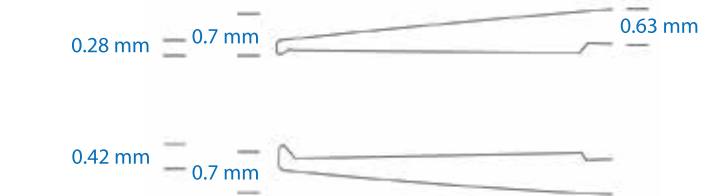

ADSONS FORCEPS / Pince d'Adson, Mors striés / Adson anatomische Pinzette, gerieft

Length : 12.5 mm
Handle length : 97 mm
14 mm serrated platform

SC119



GENERAL



ADSONS FORCEPS FINE SERRATED / Pince d'Adson, Striée, Fine / Adson anatomische Pinzette, gerieft, sehr fein

Length : 12.5 cm
Handle length : 88 mm
serrated 14 mm tying platform
32 mm platform

SC113



GENERAL



DENIS SCLERECTOMY FORCEPS / Pince à sclérectomie de Denis / Denis Sclerectomy Pinzette

Length : 10.5 cm
Handle length : 75 mm
30 mm platforms

SC104



GENERAL



EPILATION - CILIA FORCEPS / Pince à Cil / Fremdkörper & Zilienpinzette

Length : 73 mm
Platform 50 mm

SC58



GENERAL



EPILATION FORCEPS / Pince à épiler / Zilien-und Fremdkörperpinzette

Length : 88 mm
18 mm platform

SC127



GENERAL

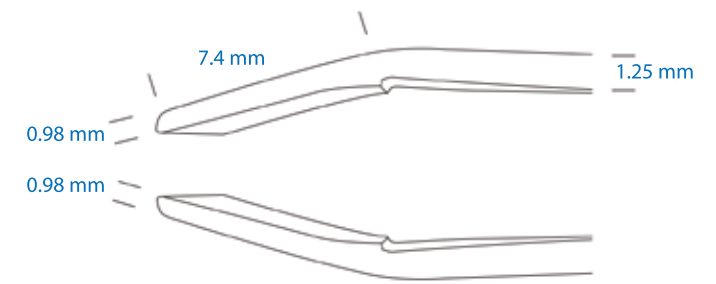

JEWELLERS FORCEPS / Pince de Joailler / Feine Fadenpinzette (Jewellers)

Length : 11.5 cm
Handle length : 82 mm
0.1 mm fine pointed ends
32 mm platform

SC60



GENERAL

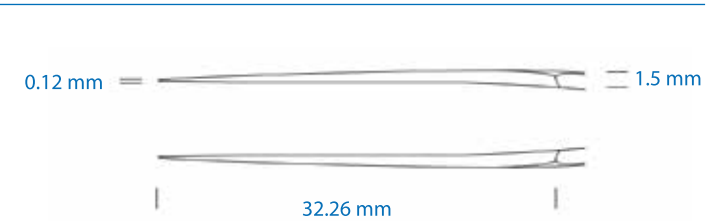

MOORFIELDS FORCEPS / Pince de Moorfield / Moorfield Pinzette

Length : 11 cm
Handle length : 68 mm
Serrated 15 mm platform

SA12



GENERAL

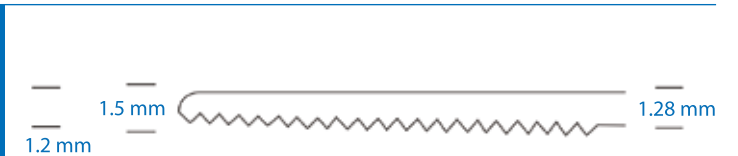

MOORFIELDS FORCEPS FINE / Pince de Moorfield Pointes fines / Moorfield Pinzette,fein

Length : 11 cm
Handle length : 71 mm
Serrated 15 mm platform

SA17



GENERAL

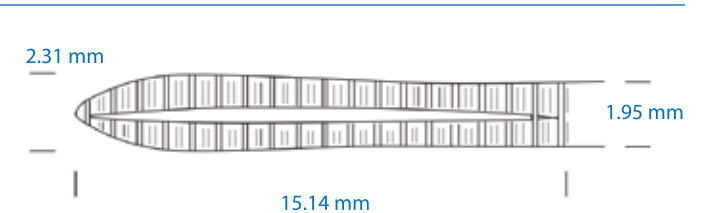

MOSQUITO FORCEPS / Pince Mosquito / Mosquito Pinzette

Length : 13 cm
22 mm serrated clamp area

SG02



GENERAL



IOL REMOVAL FORCEPS / Pince à extraction d'implant / IOL Explantations Pinzette

Length : 82 mm
Handle length : 54 mm
35° angled serrated tips
13 mm platform

SC112



LENS

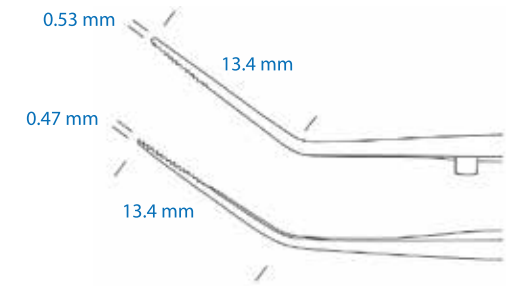

LENS FOLDING FORCEPS / Pince à implants / IOL Faltpinzette

Length : 10.5 cm
Handle length : 78 mm
45° angled
1 cm platform

SC51



LENS

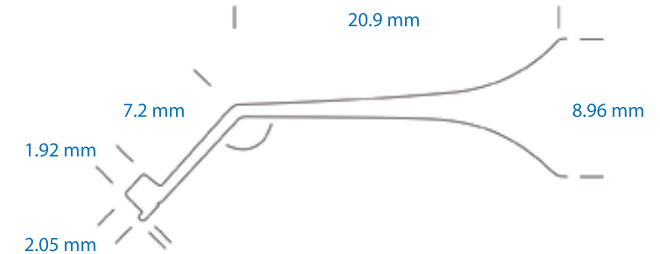

LENS IMPLANTATION FORCEPS / Pince à implantation IOL / IOL Implanations Pinzette

Length : 10.5 cm
Handle length : 76 mm
40° angled platform
10 mm platform

SC52



LENS

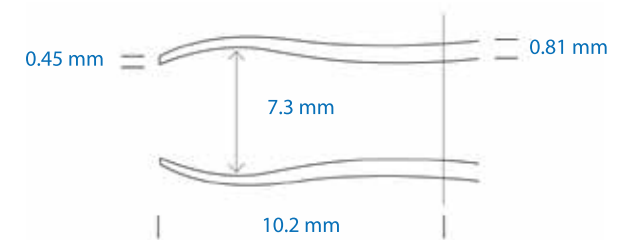

KELMAN MC PHERSON FORCEPS / Pince Kelman McPherson / Kelman Mc Pherson Pinzette

Length : 83 mm
Handle length : 57 mm
50° angled 7 mm tying platforms

SC73



TYING

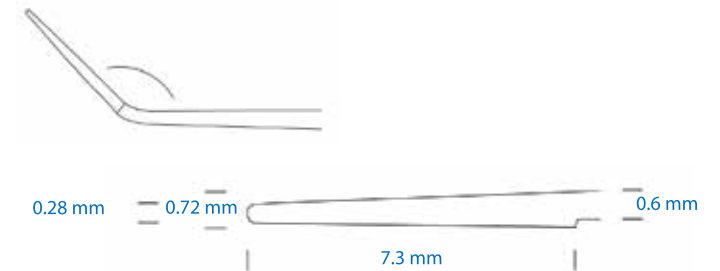

MC PHERSON TYING FORCEPS / Pince McPherson / Angewinkelte Fadenpinzette (McPherson)

Length : 10.5 cm
Handle length : 76 mm
45° angled 5 mm tying platforms

SC72



TYING

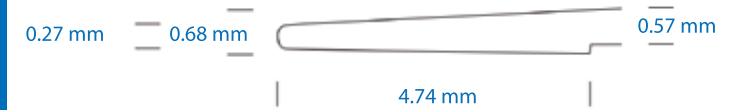

CURVED NOTCHED FORCEPS / Pince de Troutman / gebogene chirurgische Pinzette

Length : 10 cm
Handle length : 76 mm
Curved 5 mm tying platforms

SC50



TYING



STRAIGHT TYING FORCEPS / Pince à fil droite, MC / Knüpf-/Fadenpinzette gerade

Length : 85 mm
Handle length : 56 mm
5 mm tying platforms

SC19



TYING

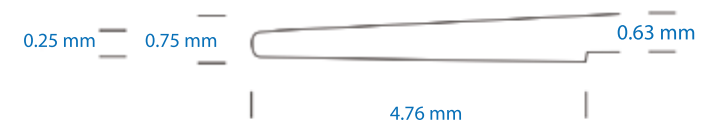

SUTURE REMOVAL FORCEPS CURVED / Pince à sutures, courbe / Fadenpinzette zur Nahtentfernung, gebogen

Length : 10.5 cm
Handle length : 76 mm
Pointed tips
5 mm tying platform

SC120



FIXATION

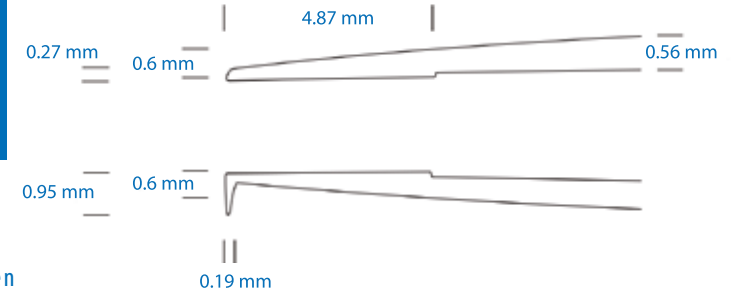

TROUTMAN TYING FORCEPS CURVED / Pince monofilament de Troutman / Knüpfpinzette nach Troutman, gebogen

Length : 10.5 cm
Handle length : 76 mm
Curved tips
5 mm tying platform

SC105



TYING

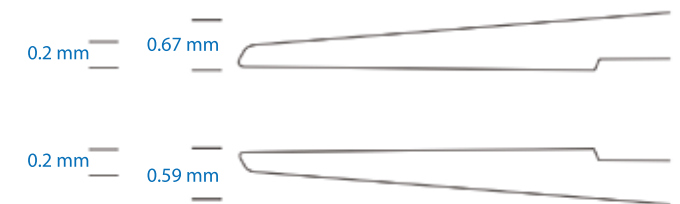

STRAIGHT TYING FORCEPS / Pince à fil droite, ML / Knüpf-/Fadenpinzette gerade

5 mm platforms
Length : 10.5 cm
Handle length : 75 mm
5 mm tying platform

SC71



TYING



LINDGREN FORCEPS / Pince de Lindgren / Lindgren Pinzette

Superior rectus forceps Curved
Length : 11.055 cm
Handle length : 70.22 mm
1 into 2 teeth

SC99



TYING

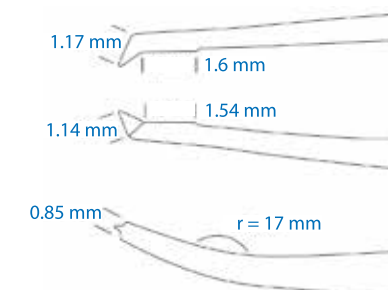

Just One Use // Das Akronym « Just One Use » bestätigt die einzigartige Verwendung unserer Instrumente. Sicherheit : Reduziert das Risiko einer Kreuzkontamination. **Wirtschaftlichkeit :** Kosten für Reparatur und Sterilisation entfallen. **Leistung :** Verwendung von medizinischem Stahl, Instrumente mit einzigartiger Ergonomie, Gewicht und Beschaffenheit, die äquivalent zu sterilisierbaren Instrumenten ist. **Komfort :** Verkürzung der Vorbereitungszeit, erhältlich als Sets oder Einzelinstrumente.

MANIPULATORS & CHOPPERS

Manipulateurs & Choppers

Manipulatoren & Chopper

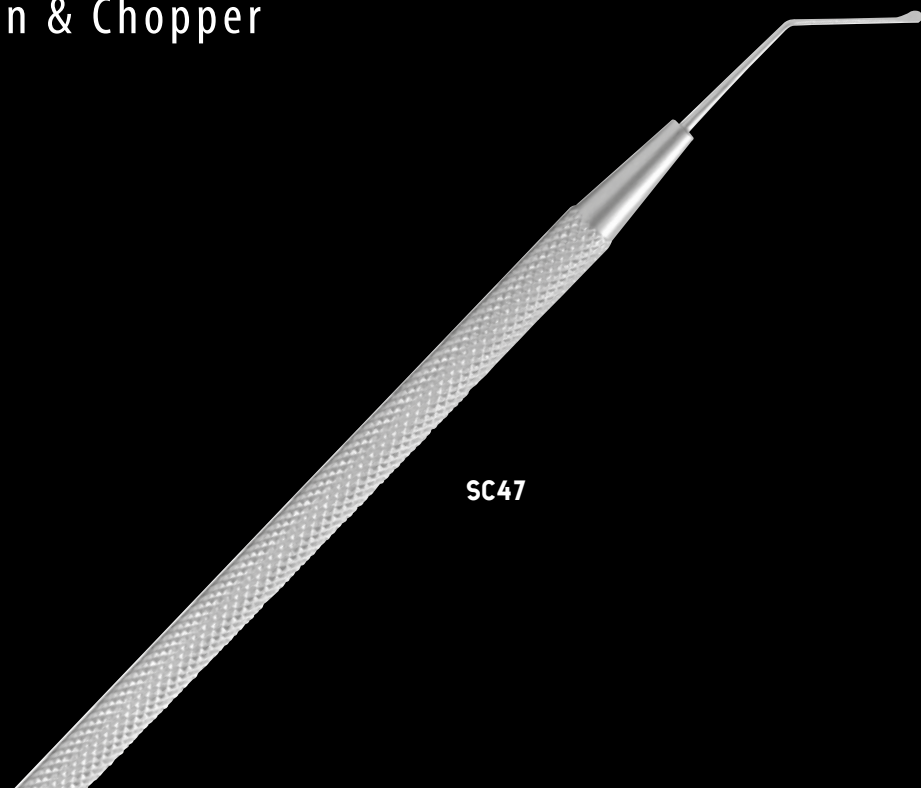

DRYSDALE NUCLEUS SPATULA

Manipulateur Drysdale
Drysdale Nucleus Manipulator

Length : 11 cm

Handle length : 85 mm

45° angled paddle shaped tip

Round bodied

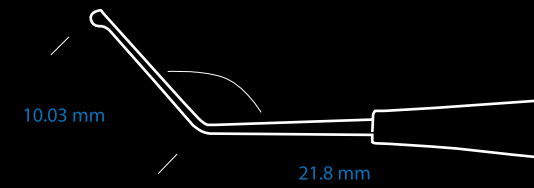

CHOPPER AND DIALLER / Double Manipulateur Chopper/Y / Chopper und Spalter

Length : 12 cm
Handle length : 76 mm
45° angled ends
One rounded tip and one 1 mm Y shaped end
Round bodied
Double ended

SC39

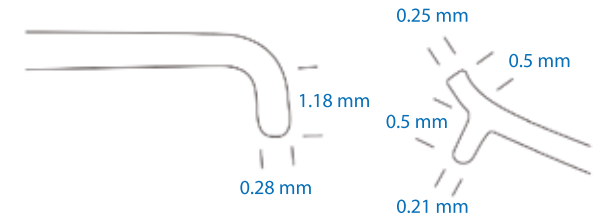

DENIS CLEAVER / Cliver de Denis / Denis Spalter

Handle length : 95 mm
0,3mm Curved Cleaver
Tip angled left 30° from 11mm 45° angled shaft
Round bodied

SC97

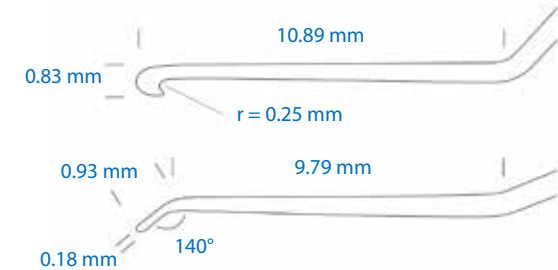

GREENS CHOPPER / Chopper de Greens / Greens Chopper

Length : 11.5 cm
Handle length : 95 mm
30° angled top curved rounded hook
Round bodied

SC45

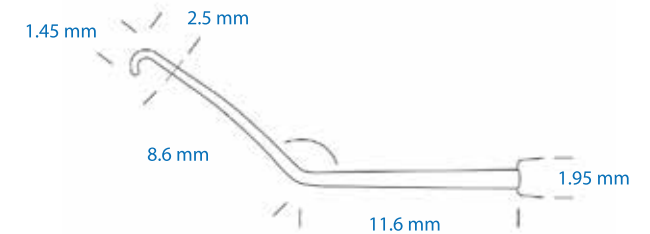

GOVAN MANIPULATOR / Manipulateur Govan / Govan Manipulator

Handle length : 95 mm
0.4 mm x 0.2 mm x 10.46 mm flattened tip
60° angle pointed tip
Round bodied

SC100



GOVAN MANIPULATOR AND PHACO CHOPPER / Chopper Phaco & Manipulateur Govan / Govan Manipulator & Phako Chopper

Length : 12 cm
Handle length : 78 mm
60° pointed end and 90° blunt end
Round bodied
Double ended

SC102

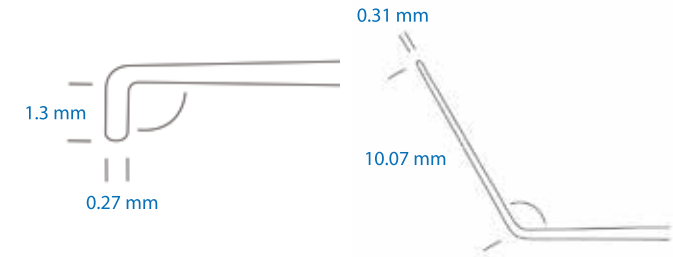

IRIS REPOSITOR / Manipulateur à iris / Iris Repositor

Length : 13 cm
Handle length : 98 mm
Round bodied

SC63

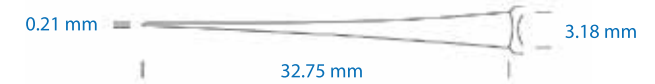

JONES CHOPPER / Chopper Jones / Jones Chopper

Length : 12 cm
Handle length : 95 mm
45° angled pointed tip
Round bodied

SC90

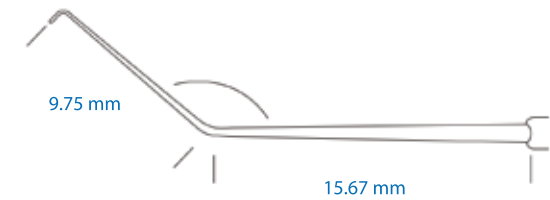

KOCH CHOPPER / Chopper Koch / Koch Chopper

Length : 12 cm
Handle length : 95 mm
45° angled 1 mm rounded tip
Round bodied

SC44

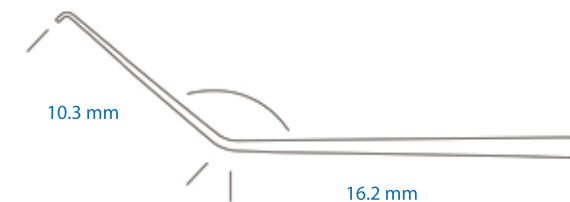

KOCH PHACO SPATULA / Spatule de Koch / Phako Spatel nach Koch

Length : 12 cm
Handle length : 96 mm
Slight curved spatula
Round bodied

SC143

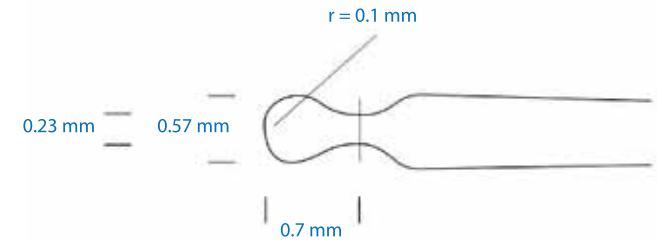

KUGLEN HOOK / Crochet de Kuglen / Häkchen nach Kuglen

Length : 11.5 cm
Handle length : 95 mm
45° angled blunt, flat hooked tip
Round bodied

SG15

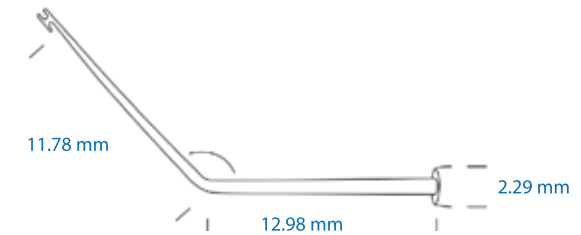

LE BUISSON MANIPULATOR / Manipulateur Le Buisson / Le Buisson Manipulator

0.40 mm x 0.50 mm x 1.00 mm Spatula Tip
Ø0.3 mm Curved 12.6 mm
90° Angled Shaft
Length : 11.5 cm
Handle length : 90 mm
Round bodied

SC106

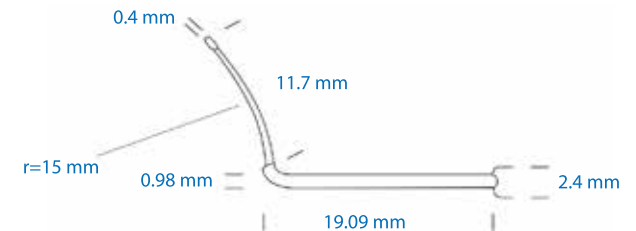

LENS DIALER (SINSKEY HOOK) / Crochet de Sinsky / Linsenhäkchen nach Sinsky

Length : 12 cm
Handle length : 95 mm
35° angled
Round bodied

SC46

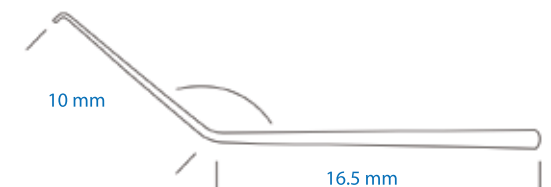

LESTER HOOK / Crochet de Lester / Lester Haken

Handle length : 95 mm
Ø0.25 mm Ball on 0.4 mm Finger
10mm 45° Angled Shaft
Length : 11.5 cm
Handle length : 10 cm
Round bodied

SC146

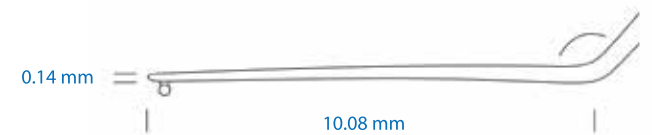

PHACO CHOPPER AND MUSHROOM MANIPULATOR DOUBLE ENDED / Manipulateur Double Chopper-Champignon / Phaco Chopper und Mushroom Manipulator (Kombi-Instrument)

Length : 12 cm
Handle length : 70 mm
45° chopper
Round bodied
Double ended

SC147

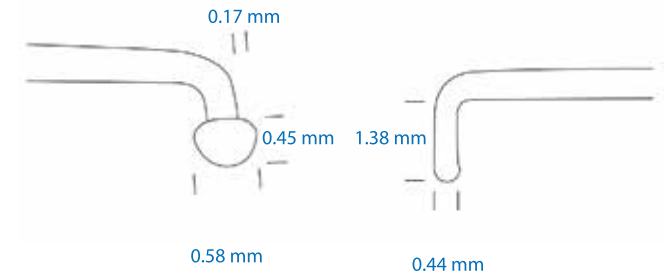

PHACO CHOPPER / Chopper Phaco / Phako Chopper

Length : 12 cm
Handle length : 95 mm
40° angled round end
Round bodied

SC43

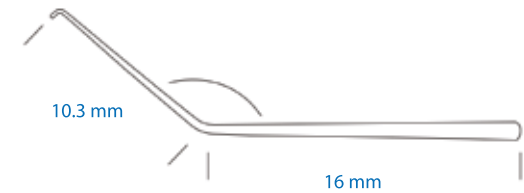

PHACO CHOPPER CLAW / Chopper Claw, fin / Phako Claw Chopper (krallen förmig, fein)

Length : 12 cm
Handle length : 95 mm
40° angled tip, hooked tip
Round bodied

SC42



PISACANO ROTATOR AND NEUHANN MANIPULATOR DOUBLE END / Manipulateur double Pisacano-Neuhann / Pisacano-Neuhann Manipulator (Kombi-instrument)

Length : 10 cm
Handle length : 75 mm
60° spatula end and 30° round end
Round bodied
Double ended

SC101



SINSKEY HOOK AND GOVAN MANIPULATOR DOUBLE ENDED / Manipulateur double Sinsky-Govan / Sinsky Håkchen und Govan Manipulator (Kombi-Instrument)

Length : 12 cm
Handle length : 76 mm
60° manipulator and 45° hooked end
Round bodied
Double ended

SC144

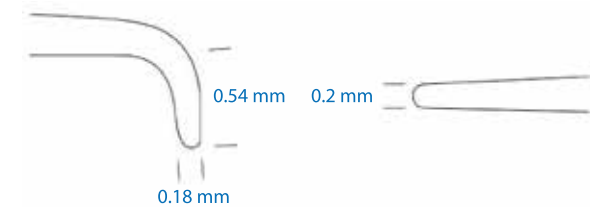

MUSHROOM NUCLEUS MANIPULATOR / Manipulateur champignon / Mushroom Nucleus Manipulator

Length : 12 cm
Handle length : 95 mm
45° angled mushroom shaped tip
Round bodied

SC48

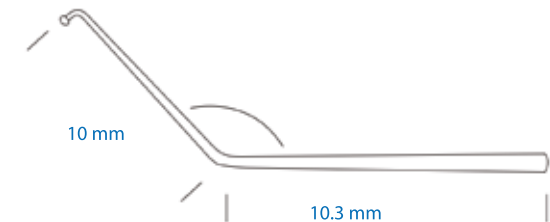

Y SHAPED NUCLEUS ROTATOR / Manipulateur de Noyau Y, Vertical / Y-Nucleus Rotator

Length : 12 cm
Handle length : 95 mm
40° angled tip Y shaped end
Round bodied

SC41



Just Quality // Quality of manufacture and irreproachable ethics.

Our instruments are CE marked and manufactured in compliance with current international standards. All our products are subject to rigorous quality testing throughout the design and manufacturing. We inspect each surgical instruments that we manufacture, and every instrument is hand finished. We strive to operate and behave in an ethical and responsible way.

SPECULUMS / Blépharostats / Lidsperrer

 **WIRE** | **MECHANICAL** | **PAEDIATRIC**

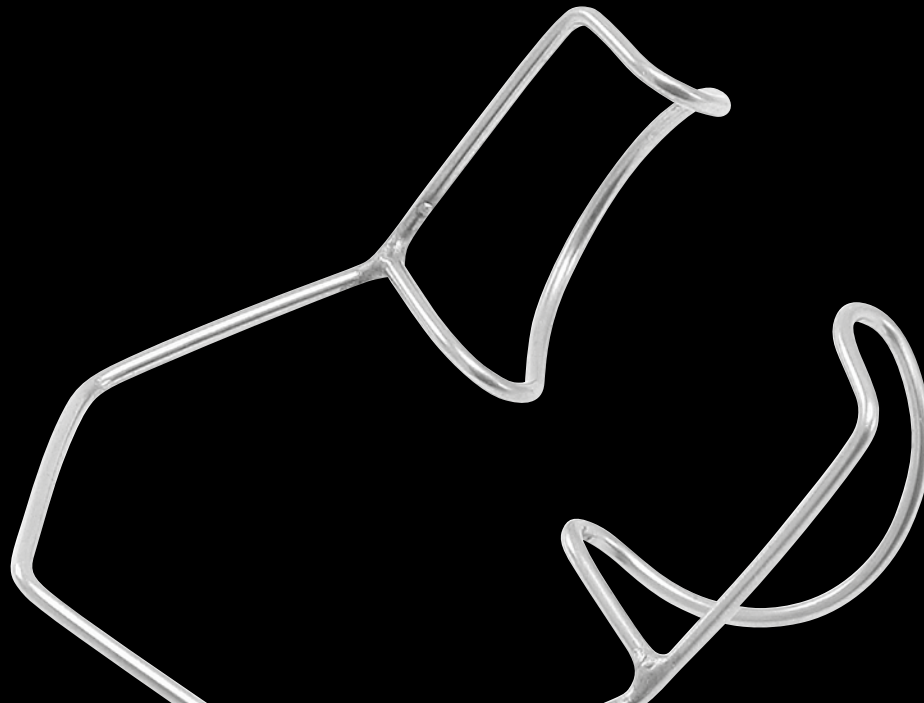

BROAD GAUGE WIRE SPECULUM / Blépharostat fils large / Breiter Gauge Draht Lidsperrer

Length : 50 mm
Width : 40 mm

SC01



WIRE

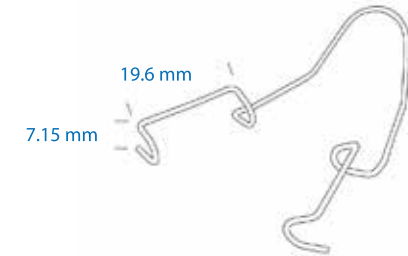

CLOSED LOOP WIDE SPECULUM / Blepharostat anses fils large / Spekulum/Lidsperrer mit geschlossenen Valven

Length : 44 mm
Width : 42 mm

SC07



WIRE

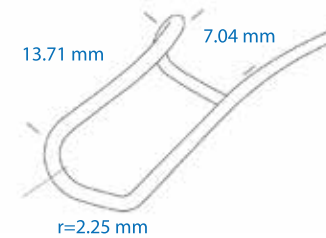

HEAVY GAUGE WIRE SPECULUM OPEN LOOP / Blépharostat fil, grand diamètre / Drahtlidsperrer groß (Heavy Gauge), offen

Length : 72 mm
Overall width : 58 mm

SC124



WIRE

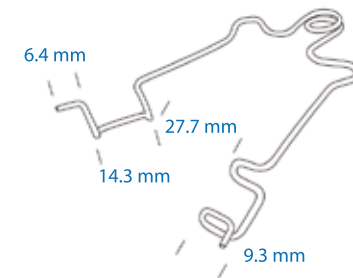

KRATZ BARRAQUER CLOSED LOOP / Blépharostat de Barraquer, fenêtré / Lidsperrer nach Kratz , gefenstert

Length : 40 mm
Width : 42 mm

SC09



WIRE



KRATZ BARRAQUER CLOSED LOOP SPECULUM / Blépharostat Kratz-Barraquer, fenêtré / Lidsperrer Kratz-Barraquer, gefenstert

Length : 43 mm
50° angle at base

SC132



WIRE

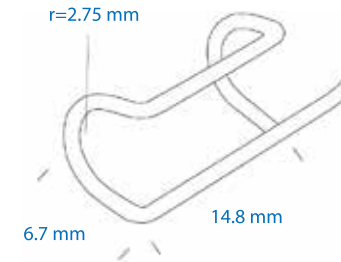

KRATZ BARRAQUER WIRE SPECULUM OPEN LOOP / Blépharostat mécanique Kratz-Barraquer, anses fil / Kratz-Barraquer Lidsperrer, feiner gebogener Draht temporal offen

Length : 47 mm
Width : 31 mm
50° angle at base

SC11



WIRE



KRATZ OPEN LOOP WIRE SPECULUM (BLUE) / Blepharostat de Kratz (bleu) / Kratz Lidsperrer mit offenen Valven (Blau)

Length : 44 mm
Overall width : 30 mm
50° angle at base

SC107



WIRE

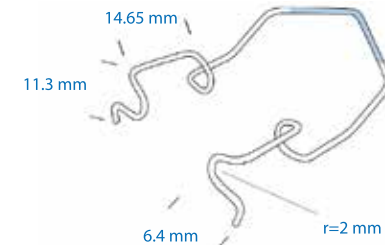

KRATZ CLOSED LOOP SPECULUM / Blépharostat temporal de Barraquer / Lidsperrer nach Barraquer, feiner gebogener Draht temporal offen

Length : 32 mm
50° angle at base

SC13



WIRE

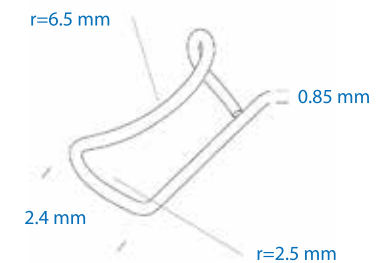

KRATZ SOLID BLADED WIRE SPECULUM / Blépharostat Kratz-Barraquer, anses pleines (Chrome) / Kratz-Barraquer Lidsperrerr, Valven aus Chrom (solid)

Length : 42 mm
Width : 30 mm
65° angleat base

SC05



WIRE

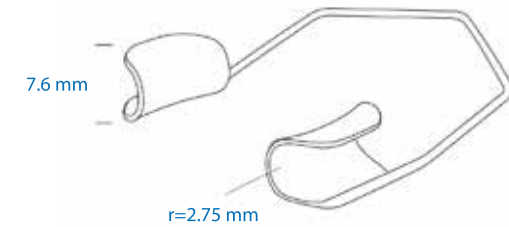

PLASTIC BLADED WIRE SPECULUM / Blépharostat Kratz-Barraquer, anses pleines (polycarbonate) / Kratz-Barraquer Lidsperrerr, mit Plastik Valven (solid)

Single use only

SC11P



WIRE



TEMPORAL SPECULUM / Blépharostat temporal de Kratz / Lidsperrerr nach Kratz, feiner gebogener Draht temporal offen

Length : 50 mm
Width : 42 mm

SC12



WIRE

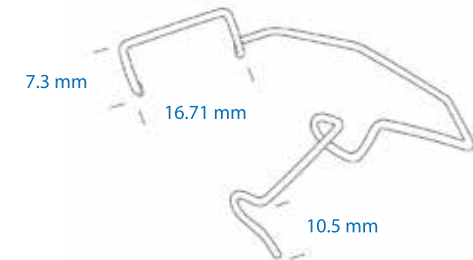

BANGERTER ADULT SPECULUM / Blepharostat de Bangerter / Lidsperrerr für Erwachsene nach Bangerter

Length : 50 mm
sliding screw adjustable
Blade length : 15 mm

SC03



MECHANICAL

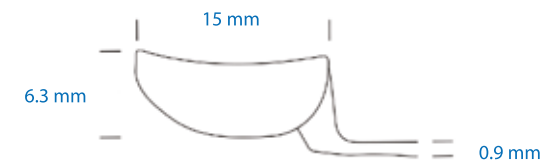

BLADED ADJUSTABLE SPECULUM / Blépharostat mécanique, anses pleines / Lidsperrer nach Barraquer, Valven aus Vollmaterial

Length : 75 mm
Blade length : 15 mm

SR10



MECHANICAL

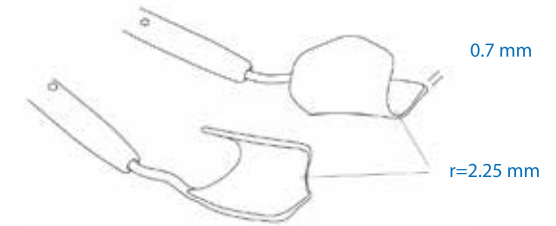

CLARKE SPECULUM / Blépharostat de Clarke / Clarke Lidsperrer

Length : 80 mm
Open loop : 12 mm

SC126



MECHANICAL

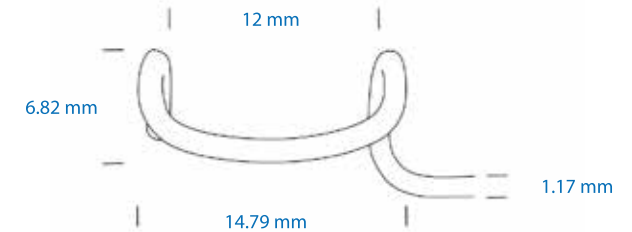

KRATZ SCREW ADJUSTABLE WIRE SPECULUM OPEN LOOP / Blépharostat mécanique Kratz, anses fil / mechanisches verstellbarer Lidsperrer nach Kratz (feiner gebogener Draht) temporal offen

Length : 78 mm
Blade length : 15 mm

SR11



MECHANICAL

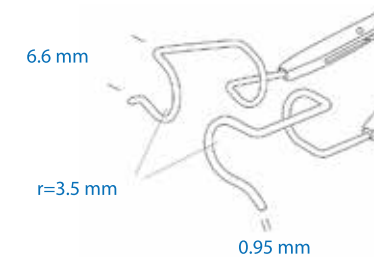

SOLID BLADED SCREW ADJUSTABLE SPECULUM / Blépharostat mécanique / Mechanisch feststellbarer Lidsperrer mit Valven aus Vollmaterial

Length : 85 mm
Blade length : 14 mm

SC08



MECHANICAL

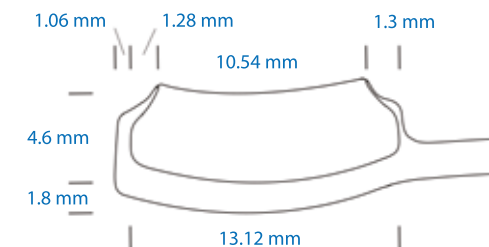

PLASTIC SCREW ADJUSTABLE OPEN LOOP WIRE SPECULUM / Blépharostat Lieberman bi-matière, fil / justierbarer Lidsperrer aus Plastik und Draht

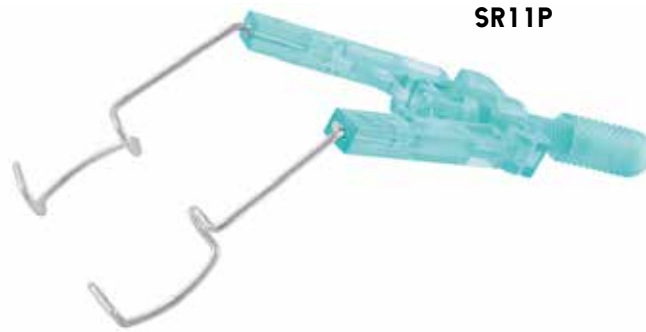

SR11P

MECHANICAL

PLASTIC SCREW BLADED SPECULUM / Blépharostat mécanique bi-matière, lames pleines / justierbares Speculum aus Plastik/Metall mit geschlossenen Valven



SR10P

MECHANICAL

KRATZ PAEDIATRIC CLOSED LOOP 10 MM SPECULUM / Blépharostat pédiatrique de Kratz / paediatrischer Lidsperrer nach Kratz 10mm

Length : 29 mm
Width : 30 mm
10 mm

SC10



PAEDIATRIC

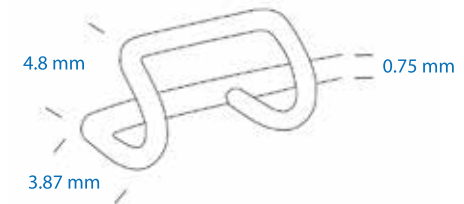

NEONATE PAEDIATRIC SPECULUM / Blépharostat néonatal Necker / Neonatal paediatrischer Lidsperrer

Length : 25 mm
Width : 20 mm
4 mm closed loop
80° angle at base

SC103



PAEDIATRIC



NEONATE 4 MM SPECULUM / Blépharostat néonatal 4mm / Neonatal Lidsperrer 4mm

Length : 25 mm
Width : 31 mm
20-30 mm adjustable
3 mm blade

SC15



PAEDIATRIC

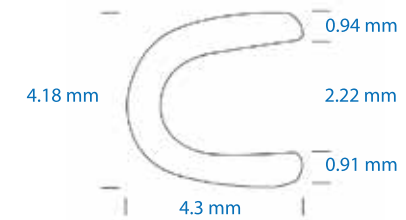

PAEDIATRIC 6 MM SPECULUM / Blépharostat pédiatrique 6mm / paediatrischer Lidsperrer 6mm

Length : 25 mm
Width : 35 mm
6 mm blade

SC14



PAEDIATRIC

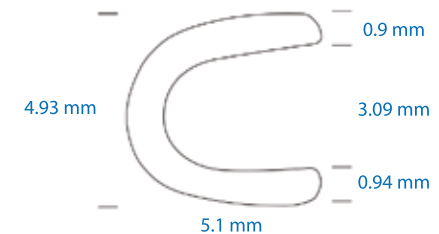

Just Quality // Une qualité de fabrication et une éthique irréprochables. Nos instruments sont marqués CE et fabriqués dans le respect des normes internationales en vigueur. Les process de fabrication intègrent des contrôles qualité et inspections, garants de la reproductibilité et de la qualité des instruments mis sur le marché. Nous nous efforçons d'agir de manière éthique et responsable.

SCISSORS / Ciseaux / Scheren

 **SPRING HANDLED | SPECULUMS PAEDIATRIC**



CASTROVIEJO CORNEAL SCISSORS RIGHT AND LEFT / Ciseaux de Castroviejo droite et gauche / Castroviejo Cornea Schere rechts und links

Length : 10 cm
Handle length : 75 mm
Castroviejo corneal scissor right (SC82)
Castroviejo corneal scissor left (SC83)
8 mm blade



SC82
SC83

SPRING HANDLED

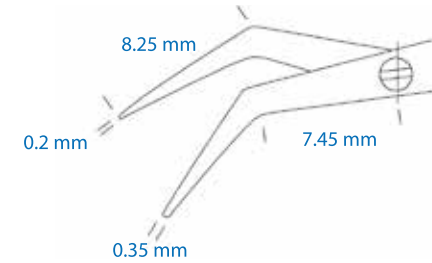

CASTROVIEJO SCISSORS STRAIGHT & ROUND / Ciseaux de Castroviejo, courbes, mousses / Castroviejo Mikro-Schere, gebogen, stumpf

Length : 11 cm
Handle : 65 cm
11 mm blade



SC110

SPRING HANDLED

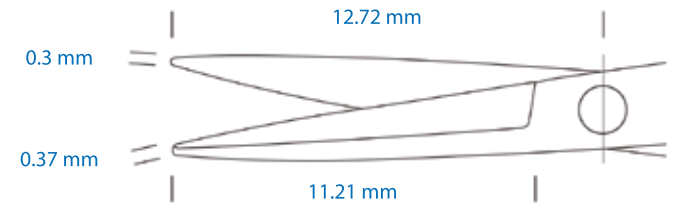

ONG IRIS SCISSORS / Ciseaux ONG / ONG Iris Schere

Length : 88 mm
Handle : 52 mm
10 mm blade



SC80

SPRING HANDLED

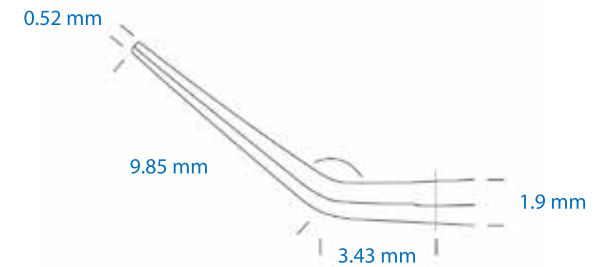

OSHER SCISSORS / Ciseaux à implant (Osher) / Osher Schere

Length : 95 mm
Handle length : 61 mm
Fine serrated cutting platform
9 mm blade



SC109

SPRING HANDLED

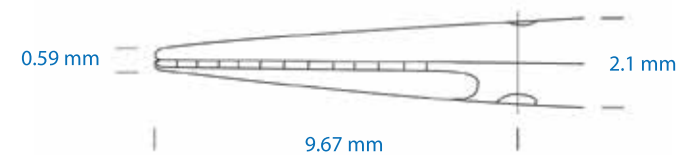

STALLARD CORNEAL SCISSORS / Ciseaux de Stallard / Stallard Hornhautschere

Length : 12 cm
Handle length : 67 mm
Fine pointed ends
40 mm blade

SA13



SPRING HANDLED

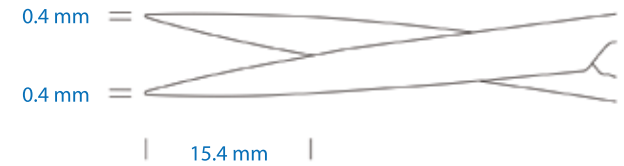

VANNAS SCISSORS / Ciseaux de Vannas / Vannas Schere

Length : 83 mm
Handle length : 52 mm
8 mm blade

SC81



SPRING HANDLED

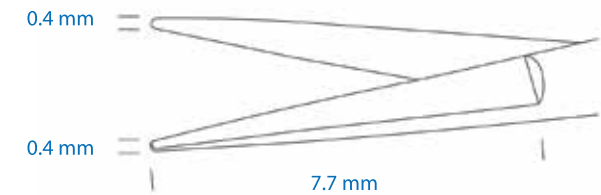

VANNAS SCISSORS CURVED / Ciseaux de Vannas, courbes / Vannas Schere gebogen

Length : 10 cm
Handle length : 62 mm
Sharp pointed end
9 mm blade

SC108



SPRING HANDLED

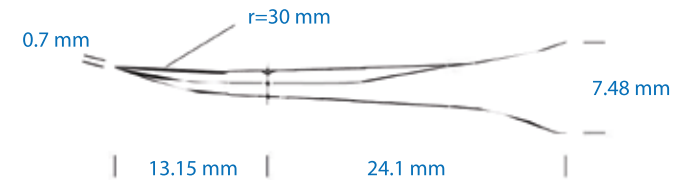

WESTCOTT CONJUNCTIVAL SCISSORS / ciseaux de Westcott, courbes / Westcott Bindehautschere

Length : 11.5 cm
Handle length : 79 cm
12 mm blade

SA11



SPRING HANDLED



WESCOTT SCISSORS DOLPHIN NOSE / Ciseaux de Wescott, extrémités émoussées (en forme de dauphin) / Westcott Schere, stumpfe Enden (delphinförmig)

Length : 11.5 cm
 Handle length : 67 mm
 10 mm blade



SPRING HANDLED

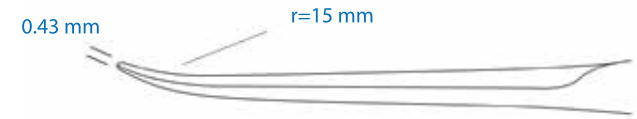

CASTROVIEJO SCISSORS STRAIGHT / Ciseaux de Castroviejo, droits / Castroviejo Schere, gerade

Length : 10 cm
 Handle length : 63 mm
 Straight tipped
 60 mm blade



SPRING HANDLED

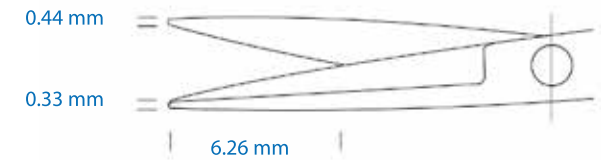

DRESSING SCISSORS / Ciseaux à disséquer, extrémités courbes et mousses / Verbandsschere gebogen mit abgerundete Spitze

Length : 11.5 cm
 Handle length : 26 mm
 30 mm blade



GENERAL



ENUCLEATION SCISSORS / Ciseaux à énucléation / Enukleationsschere

Length : 25 mm
 6 mm blade



GENERAL



GENERAL LONG HANDLE SCISSORS BLUNT END / Ciseaux courbes, bout mousse, manche long / Augenschere lang, stumpfe Enden

Length : 13 cm
Blunt round end
40 mm blade



SG14

GENERAL

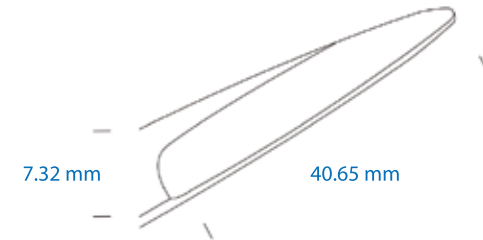

GENERAL SCISSORS BLUNT END / Ciseaux courts, pointes droites, bout mousse / Augenschere, stumpfe Enden

Length : 89 mm
Blunt end
24 mm blade



SG06

GENERAL

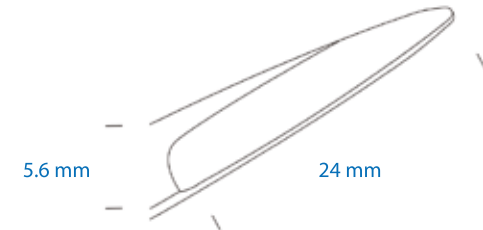

GENERAL SCISSORS SHARP POINTED / Ciseaux courts pointus / Augenschere, spitze Enden

Length : 88 mm
Sharp pointed end
22 mm blade



SG01

GENERAL



METZENBAUM SCISSORS CURVED POINTED / Ciseaux de Metzenbaum, courbes, pointus / Metzebaum Schere, gebogen, spitz

Length : 11cm
35 mm blade



SG30

GENERAL

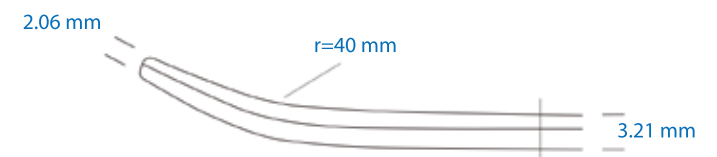

STRABISMUS SCISSORS / Ciseaux à strabisme / Strabismus Schere

Length : 11.5 cm
Blunt end
38 mm blade

SG07



SPRING HANDLED



STEVENS SCISSORS CURVED / Ciseaux de Stevens courbes / Schere nach Stevens, gebogen

Length : 11.5 cm
38 mm blade
30 mm tip

SG23



SPRING HANDLED

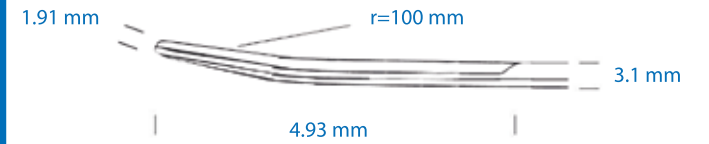

IRIS SCISSORS / Ciseaux à iris, ciseaux à disséquer, droits, pointus / Iris Schere, gebogen

Sharp, pointed end
Overall length : 109.89 mm
Blade length : 22.5 mm
Tip width : 0.72 mm

SC96



SPRING HANDLED

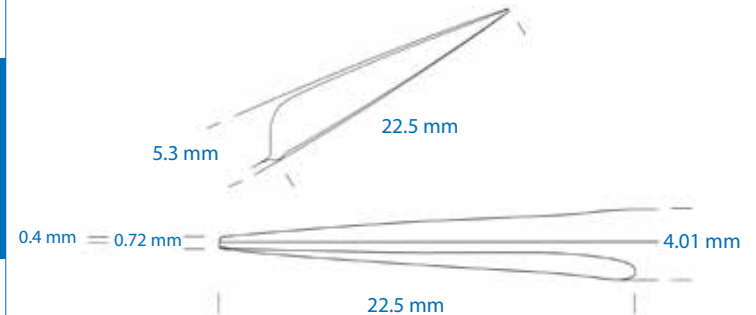

Just Quality // Qualität der Herstellung und einwandfreie Ethik.

Unsere Instrumente sind CE-gekennzeichnet und werden in Übereinstimmung mit den aktuellen internationalen Standards hergestellt. Zu den Fertigungsprozessen gehören Qualitätskontrollen und Prüfungen, die Reproduzierbarkeit und die Qualität der auf den Markt gebrachten Geräte garantieren. Wir bemühen uns, ethisch und verantwortungsvoll zu handeln.

MEASURERS & MARKERS

Mesureurs & Marqueurs

Messinstrumente & Marker



BRAUNSTEIN CALIPER PLASTIC / Marqueur de Braunstein, plastique / Braunstein Kaliber aus Plastik

Single use only

SG04P

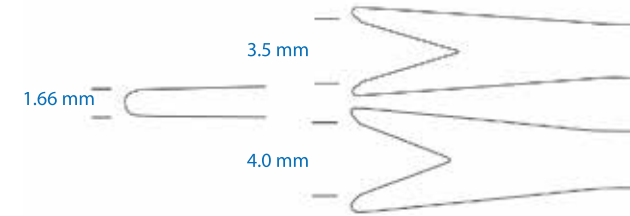

BRAUNSTEIN FIXED CALIPER 1.8 MM THICKNESS / Marqueur de Braunstein, métal / Braunstein Kaliber fix 1.8mm Dicke

Length : 68 mm
3.5 mm 4 mm measure

SG04

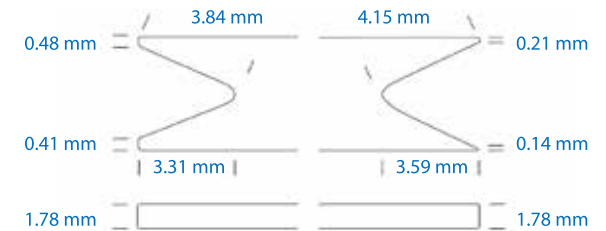

CASTROVIEJO ADJUSTABLE CALIPER / Compas de Castroviejo, pointes droites / Castoviejo verstellbarer Zirkel

Length : 85 mm
20 mm measure

SG05

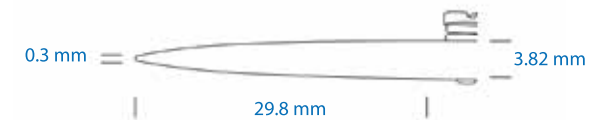

HELVESTON RULER / Règle d'Helveston / Helveston Meßspatel

Overall Length : 117.96 mm
Handle Length : 89.42 mm

SG93

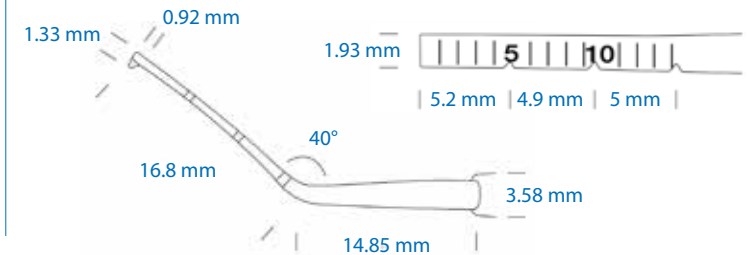

INJECTION MARKER / Marqueur fixateur IVT / Injektions Marker

Length : 70 mm
Handle length : 58 mm
plastic marking end
Single use only

SC64



MENDEZ GAUGE / Anneau de Mendez / Messlehre nach Mendez (zur Bestimmung des Einschnittwinkels)

Length : 12 cm
Handle length : 80 mm
180° circular marker

SC65

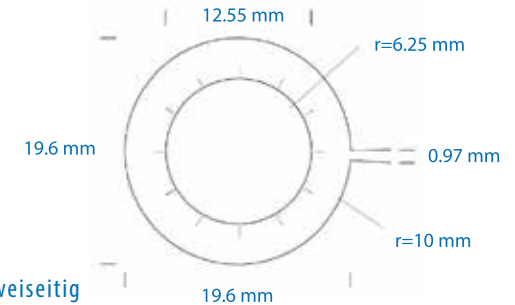

SCLERAL MARKER ROUND BODIED DOUBLE ENDED / Marqueur scléral métal 3.5 mm - 4.5 mm / Skleral Marker runder Griff, zweiseitig

4.5 mm and 3.5 mm marking ends
Length : 11 cm
Handle : 60 mm
Round bodied
Double ended

SG19

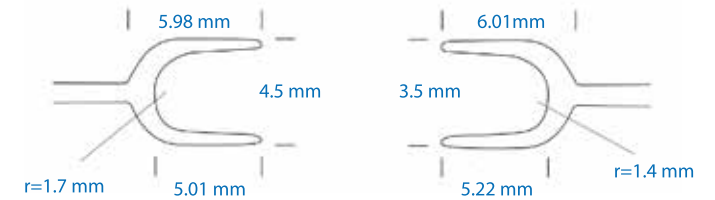

8 LINE CORNEAL MARKER / Marqueur cornéen 8 branches / sternförmiger Kornea Marker mit 8 Linien

Overall Length : 109.81 mm
Handle length : 81.23 mm

SR72

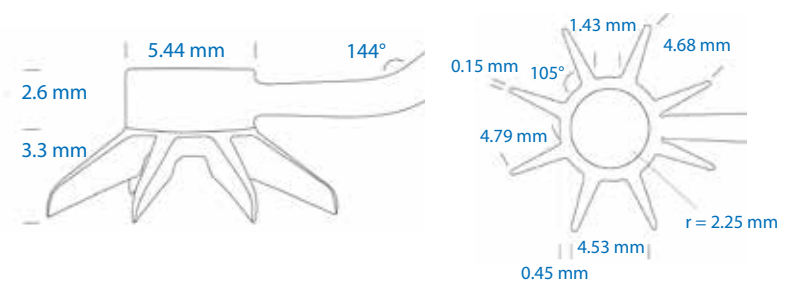

Just Innovation // Continuous improvement and innovation are our driving force.

Our research and development team is constantly monitoring the market in order to offer surgical instruments in line with expressed needs. Our know-how is at the disposal of the users for any request for development of new or custom made instruments.

CURETTES & CLAMPS

Curettes & Pincers
Küretten & Klemmen



CS03

CHALAZION CLAMP MEDIUM

Pince à chalazion medium
Chalazion Klemme Medium

Overall Length : 89.97 mm
Handle Length : 54.56 mm
All Measurements : +/- 0.05 mm

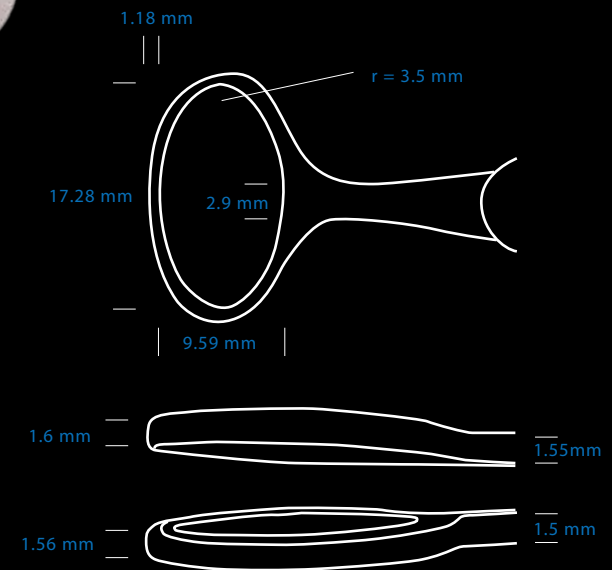

CURETTE VARIOUS SIZES / Currettes à chalazion / Küretten verschieden Größen

Length : 11 cm
Handle length : 80 mm
CR01 Curette small
CR02 Curette medium,
 (2.5 mm diameter chalazion curette)
CR03 Curette large,
 (4 mm oval shaped chalazion curette)

CR01
CR02
CR03



CURETTES

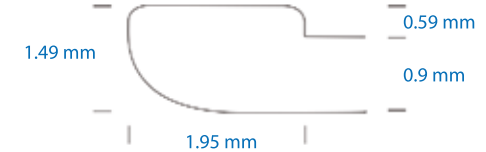

CURETTE DOUBLE ENDED / Curette double / Kürette zweiseitig

Length : 13cm
Handle length : 65 mm
Chalazion curette 2.5 mm diameter end
and oval end

CR05



CURETTES

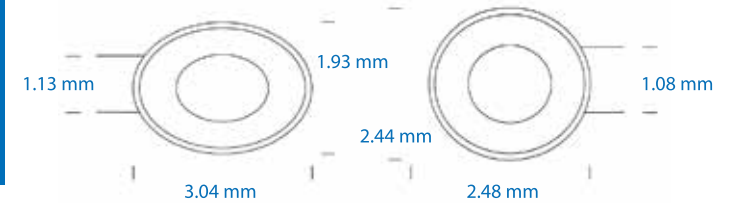

CHALAZION CLAMP SMALL / Pince à chalazion 12mm / Chalazion Klemme klein

Length : 11.5 cm
Handle length : 82 mm
12 mm diameter plate

CS01



CLAMPS

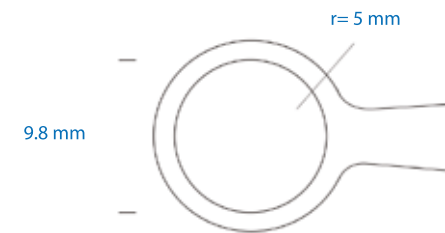

CHALAZION CLAMP LARGE / Pince à chalazion large, ovale / Chalazion Klemme groß

Length : 85 mm
Handle length : 53 mm
21 mm diameter oval plate

CS02



CLAMPS

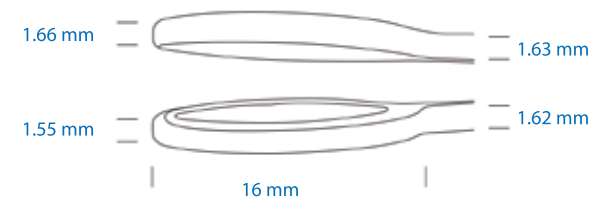

Just Innovation // L'amélioration continue et l'innovation sont nos moteurs.

Notre équipe de recherche et développement est constamment à l'écoute du marché, afin de proposer des instruments chirurgicaux en adéquation avec les besoins exprimés. Notre savoir-faire est à la disposition des utilisateurs pour toute demande de développement d'instruments nouveaux ou sur-mesure.

NEEDLE HOLDERS

Porte-Aiguilles

Nadelhalter



SC61

SUTURE NEEDLE HOLDER CURVED

Porte-aiguille, mors courbes

Nähnelhalter, gebogen

Length : 13.5 mm

Handle length : 86 mm

6 mm jaw

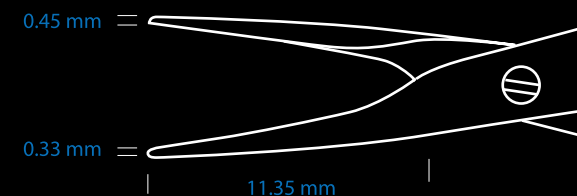

BARRAQUER NEEDLE HOLDER CURVED / Porte-Aiguille de Barraquer, courbe / Barraquer Nadelhalter gebogen

Length : 11.5 cm
Handle length : 82 mm
12 mm diameter plate
Round bodied

SC142

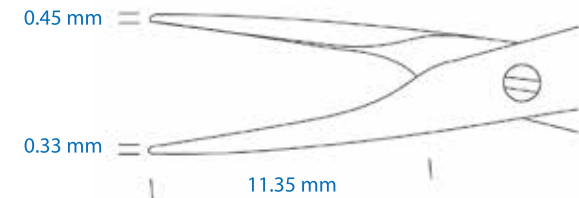

CASTROVIEJO NEEDLE HOLDER LOCKING / Porte-aiguille de Castroviejo droit, verrou / Castroviejo Nadelhalter mit Sperre

Length : 14 cm
Handle length : 82 mm
Straight tips 20.73 mm
Flat handle

SC118

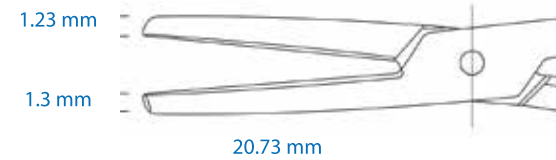

NEEDLE HOLDER BLUNT LOCK / Porte-aiguille, bout mousse, verrou / Nadelhalter stumpf, mit Sperre

Length : 13.5 cm
Handle length : 82 mm

SC62

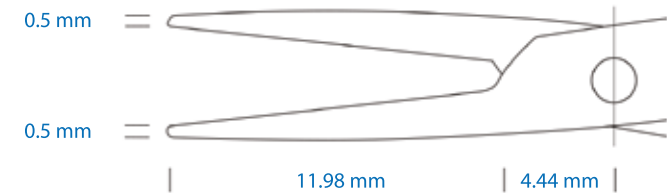

NEEDLE HOLDER CURVED / Porte-aiguille, courbe / Nadelhalter, gebogen

Length : 10 cm
Handle length : 75 mm

SC114

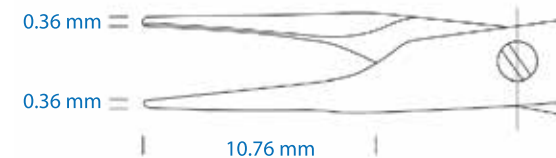

Just Innovation // Unser Bestreben sind kontinuierliche Verbesserung und Innovationen.

Unser Forschungs und Entwicklungsteam hat ständig ein offenes Ohr am Markt, um chirurgische Instrumente entsprechend den Anforderungen anzubieten. Unser Know-how steht den Benutzern für jede Anfrage zur Entwicklung neuer oder maßgeschneiderter Instrumente zur Verfügung.

LACRIMAL

Lacrymal

Lakrimal

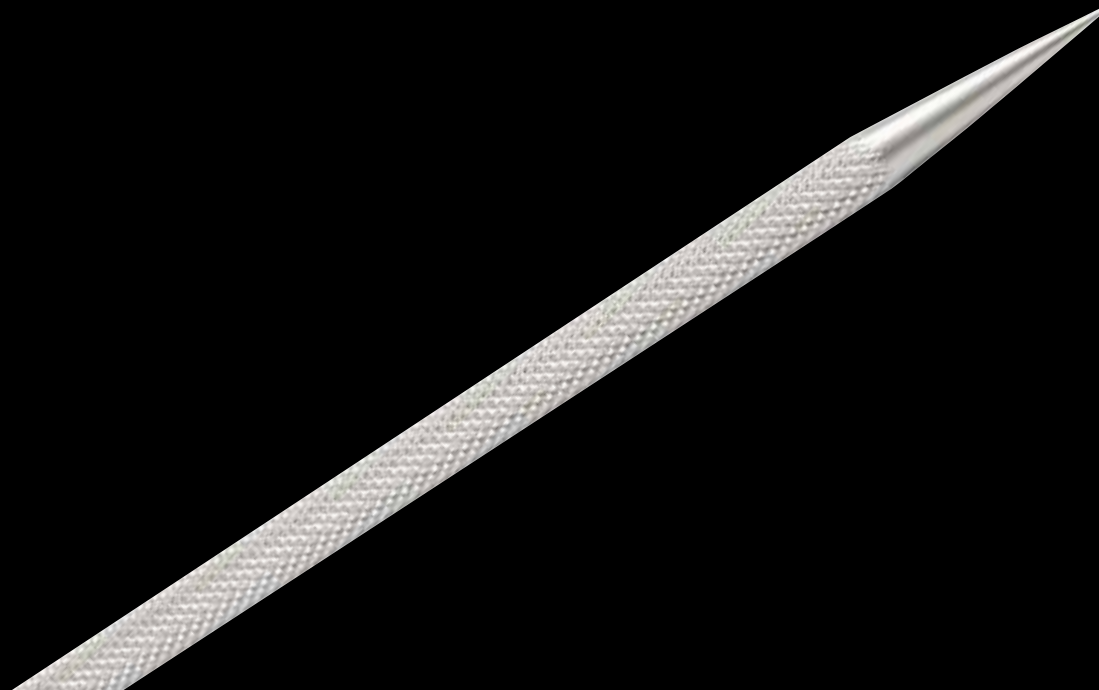

BOWMANS PROBE SIZE 00-0 DOUBLE ENDED / Sonde de Bowman double 00-0 / Tränenwegsonde Bowman Größe 00-0 zweiseitig

Length : 50 mm
Handle length : 30 mm

PD05

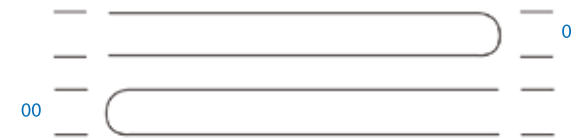

BOWMANS PROBE SIZE 000-00 DOUBLE ENDED / Sonde de Bowman double 000-00 / Tränenwegsonde Bowman Größe 000-00 zweiseitig

Length : 50 mm
Handle length : 30 mm

PD06

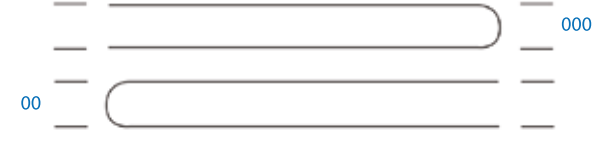

LACRIMAL PROBE / Sonde à voies lacrymales / Lakrimal Sonde

Length : 95 mm
Handle length : 15 mm
0.5 mm pointed end

PD08



PUNCTAL DILATOR BLUNT / Dilatateur voies lacrymales, mousse / Tränenwegsonde stumpf

Length : 95 mm
Handle length : 80 mm
0.4 mm pointed sharp end
Round bodied

PD02



PUNCTAL DILATOR DOUBLE ENDED / Dilateur voies lacrymales, fin-medium / Tränenwegsonde zweiseitig

Length : 11.5 cm
Handle length : 85 mm
0.4 and 0.3 mm sharp pointed ends
Round bodied



PD03

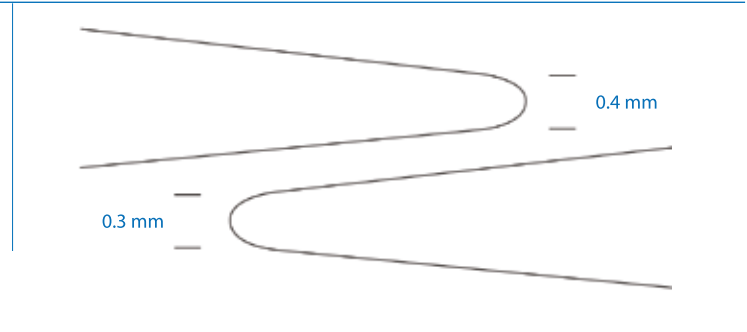

PUNCTAL DILATOR SHARP / Dilateur voies lacrymales, très fin / Tränenwegsonde scharf

Length : 95 mm
Handle length : 78 mm
0.2 mm pointed sharp end
Round bodied



PD01

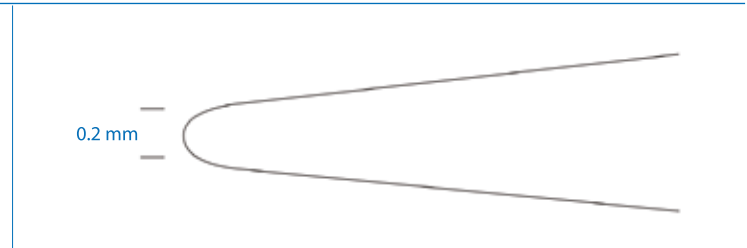

PUNCTAL DILATOR SHORT / Dilateur voies lacrymales, manche court / Tränenwegsonde kurz

Length : 50 mm
Handle length : 30 mm
0.3 mm sharp pointed ends
Round bodied



PD04

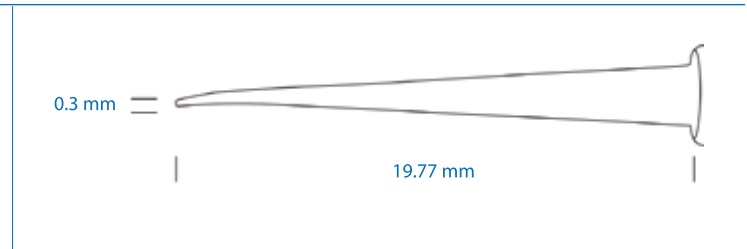

PUNCTAL DILATOR & LACRIMAL PROBE DOUBLE ENDED / Dilateur-Sonde pour voies lacrymales / Tränenwegsonde zweiseitig

Length : 14 cm
Handle length : 70 mm
curved and pointed end



PD07

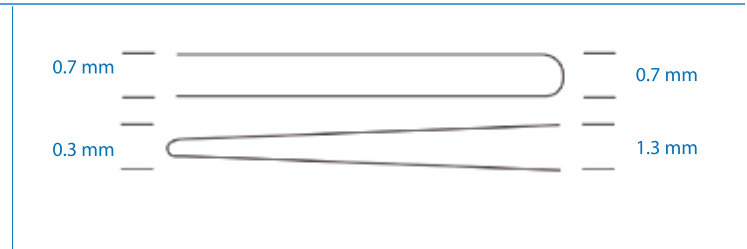

CORNEAL & REFRACTIVE

Cornée & Réfractive
Korneal & Refraktiv

NEORIS POCKETING SPATULA DOUBLE ENDED
Spatule double NEORIS
Neoris Taschenspatel zweiseitig

Overall Length : 118.57 mm
Handle Length : 71 mm

SR12

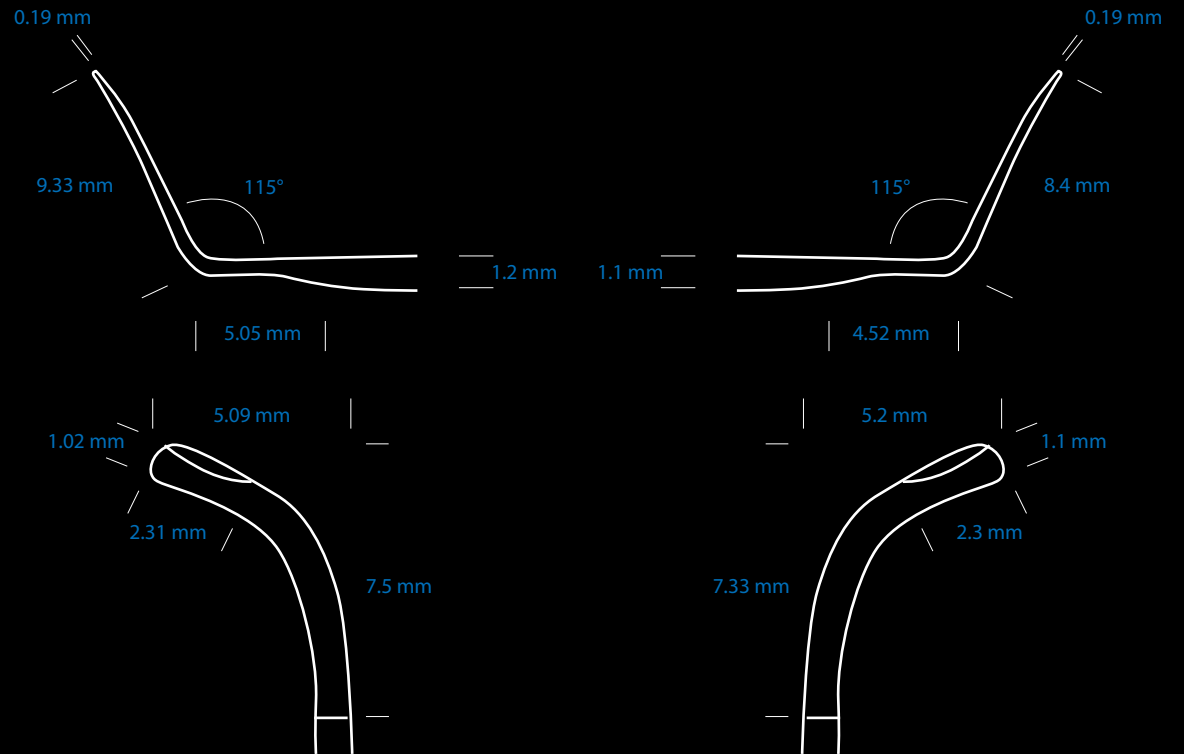
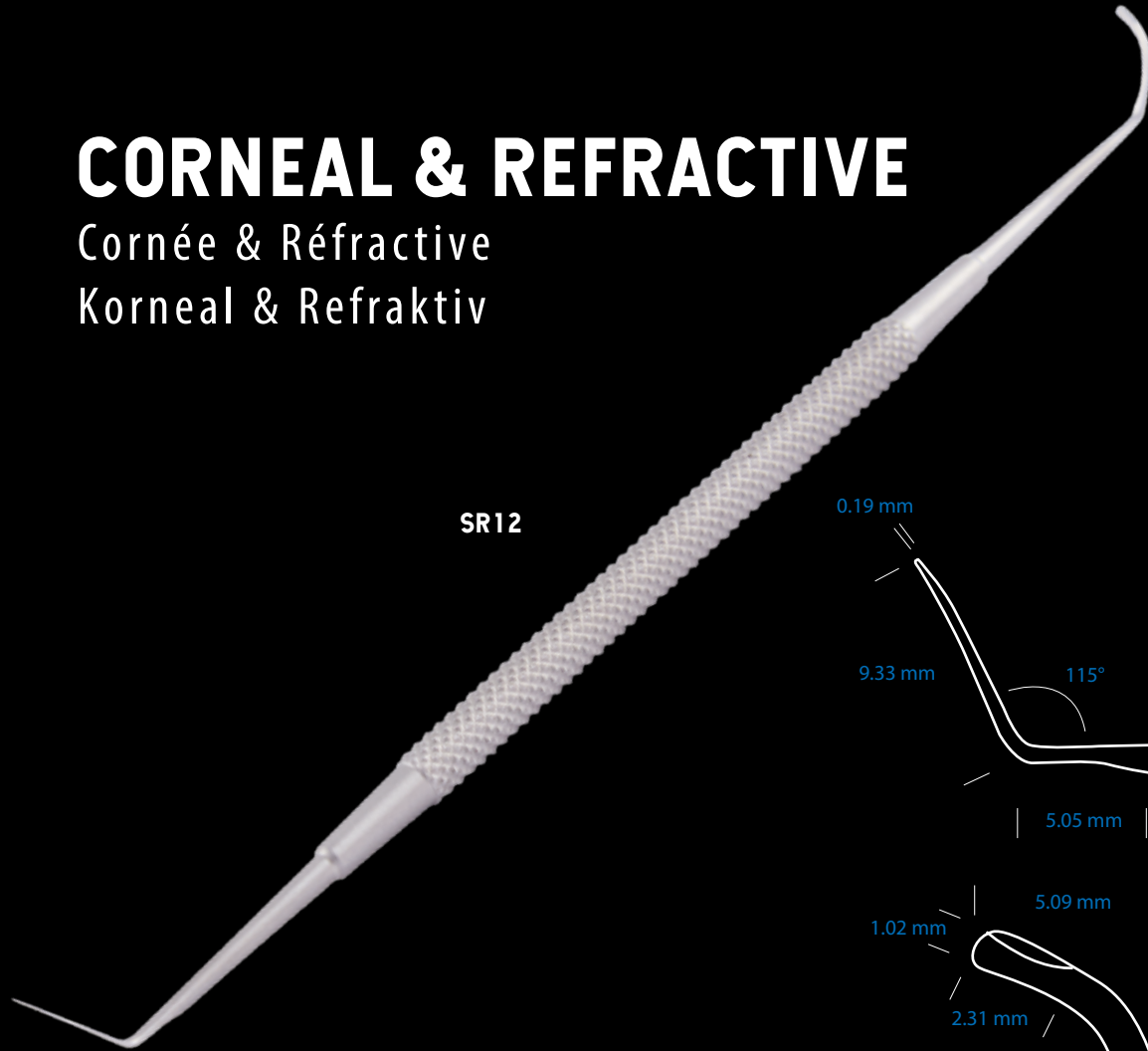

DMEK BERNHEIM HOOK / Crochet DMEK de Bernheim / DMEK Häkchen nach Bernheim

Length : 12 cm
Handle length : 95 mm

SR109



CORNEAL EPITHELIUM SPATULA ROUND / Spatule pour épithélium cornéen, ronde / Epithelium Hornhautspatel, rund

Length : 11 cm
Handle length : 85 mm

SR100



CK LASIK MARKER / Marqueur LASIK avec croix de centrage / Hornhautmarker mit Fadenkreuz

Length : 10 cm
Handle length : 76 mm
facilitate marking of the cornea
Round bodied

SR40

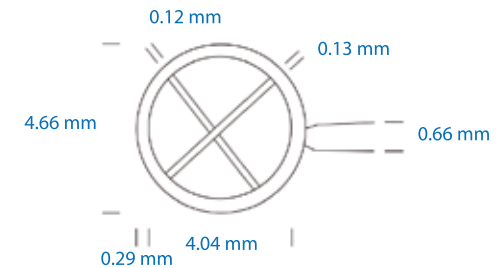

EPI PEELER / Scarificateur cornéen / Epi Peeler

Length : 11 cm
Handle length : 95 mm
Manipulate epithelium during surgery

SR51

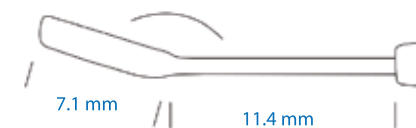

EPI PEELER RECTANGLE SHAPED / Scarificateur, forme D / Epi Peeler - quadratische Form (LASIK)

Length : 11 cm
Handle length : 95 mm

SR61

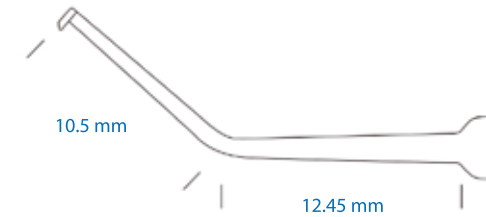

EPI PEELER D SHAPED / Scarificateur Micro-Houe / Epi Peeler, gebogen

Length : 11 cm
Handle length : 95 mm

SR60

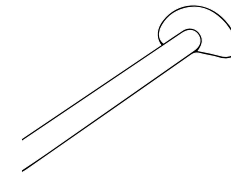

INTRA LASIK FLAP SEPARATOR / Elévateur volet cornéen, crochet pointu / Intra-Lasik Flap Separator

Length : 12 cm
Round bodied

SR34

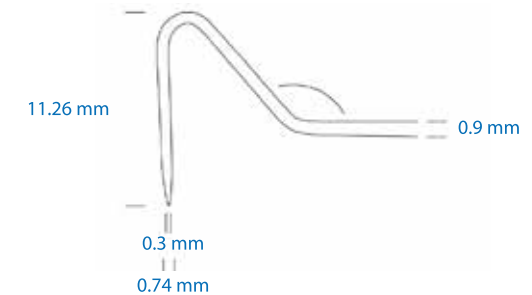

KOCABA DMEK FORCEPS / Pince DMEK de Kocaba / Kocaba DMEK Pinzette

Length : 86 mm
Handle length : 56 mm

SR102

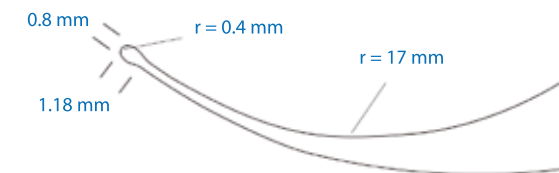

ALCOHOL WELL VARIOUS SIZES / Anneau marqueur / Lasek Alkohol Trichter

Length : 12.5 cm
 Handle length : 92 mm
 Liquid holding well for alcohol application
 Round bodied
 SR41 9 mm
 SR42 8 mm
 SR43 7 mm



SR41

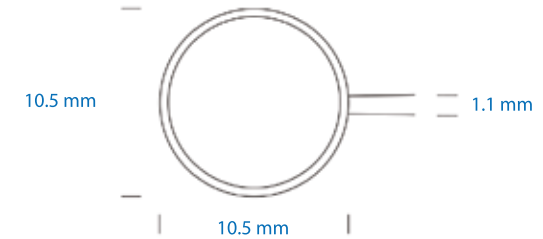

LASIK CORNEAL MARKER / Marqueur cornéen en fourche / Lasik Hornhautmarker

Length : 12 cm
 Handle length : 91 mm
 Y shaped forked marker



SR21

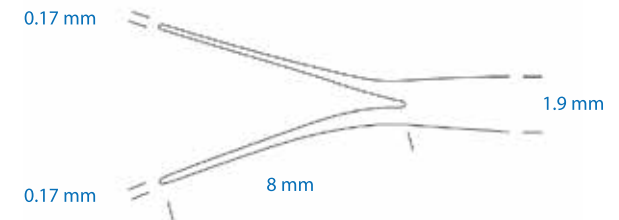

LASIK FLAP ELEVATOR / Spatule Flap Lasik / LASIK Flap Heber

Length : 12 cm
 Handle length : 95 mm
 45° angled, 12 mm tip with 0.1 mm rounded end



SR31

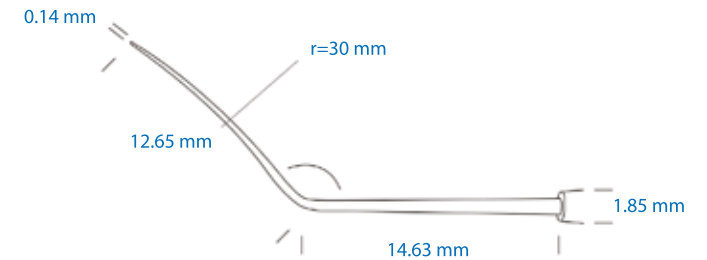

LASIK FLAP FORCEPS / Pince Flap Lasik / Lasik Flap Pinzette

Length: 10 cm
 Handle length: 77 mm
 40° angled platform, circular 1 mm tips



SR71

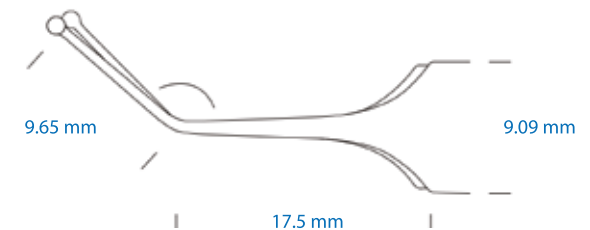

LASIK FLAP SEPERATOR AND ELEVATOR DOUBLE END / Séparateur-élevateur LASIK, droit / Lasik Flap Separator / Flap Heber gerade

Length : 12 cm
Handle length : 70 mm
45° and 65° ends
Double ended

SR103

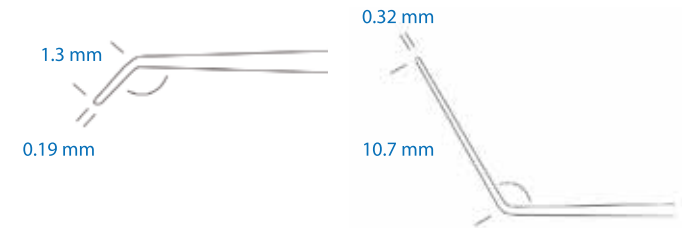
LENTICULE SEPERATOR HOOK AND SPATULA DOUBLE END / Relex Crochet / Séparateur, Spatule / Relex Håkchen / Separator (Kombi-Instrument)

Length : 11 cm
Handle length : 70 mm
75° ends
Double ended

SR104

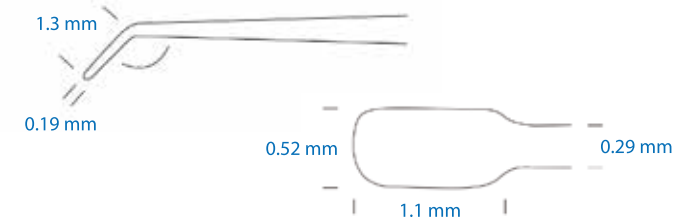
S MARKER / Marqueur DMEK «S» / S Marker

Length : 11 cm
Handle length : 90 mm
45° angle 2 mm marking end

SR101

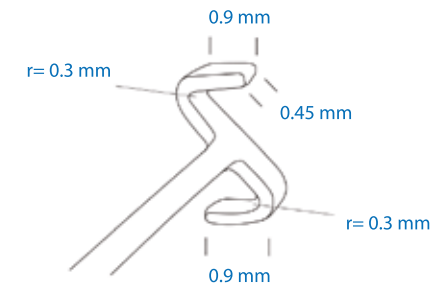
TREPHINE VARIOUS SIZES / Trépan cornéen / Trepane verschiedene Größen

SR105 17 mm
SR106 18 mm
SR107 19 mm
SR110 16 mm

SR105

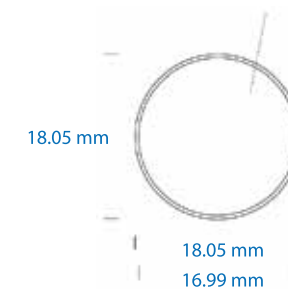

LASIK FEMTO SEPERATOR AND ELEVATOR DOUBLE ENDED / Séparateur-Élévateur Siebel / Lasik Femto Seperator und Elevator zweiseitig

Length : 11.525 cm
Handle length : 70.3 mm
Round bodied
Double ended



SR02

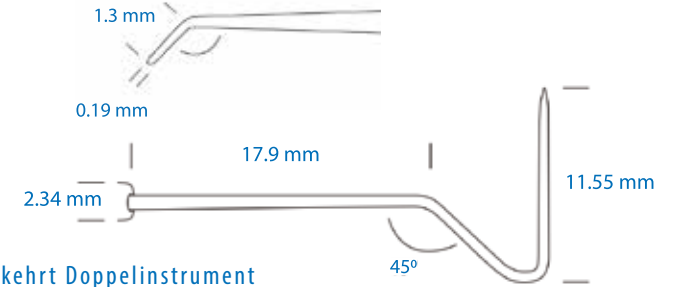

SINSKEY AND REVERSE SINSKEY HOOK / Manipulateur double Sinskey-Sinskey inversé / Sinskey Håkchen umgekehrt Doppelinstrument

Length : 12.077 cm
Handle length : 70.37 mm
Round bodied
Double ended



SR03

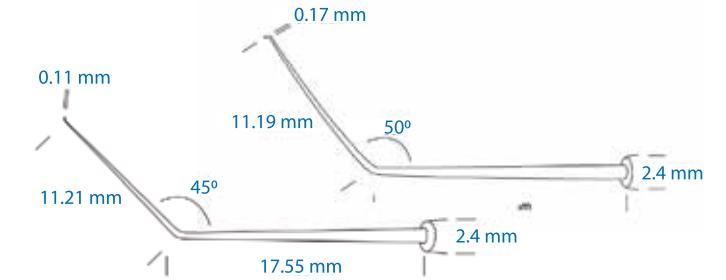

CORNEAL RING PUSHER / Manipulateur anneau intra-cornéen / Manipulator für Cornealen Ring

Length : 11.019 cm
Handle length : 91.1 mm
Round bodied



SR04



CORNEAL RING POCKETING HOOK / Crochet anneau intra-cornéen / Taschen Haken für Cornalen Ring

Length : 11.143 cm
Handle length : 91.07 mm
Round bodied



SR05



CORNEAL RING POCKET SPREADER / Spatule anneau intra-cornéen / Taschen Spreizer für Cornealen Ring

Overall Length : 108.9 mm
Handle Length : 90.16 mm
All Measurements +/- 0.05 mm

SR06

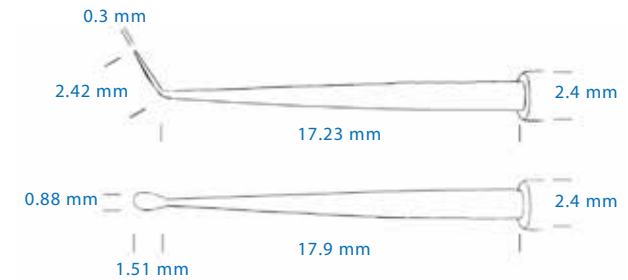

CORNEAL RING FORCEPS KERARING / Pince à anneau intra-cornéen - Keraring / Keraring Pinzette für Cornealen Ring

Overall Length : 102.92 mm
Handle Length : 77.3 mm
All Measurements +/- 0.05 mm

SR07

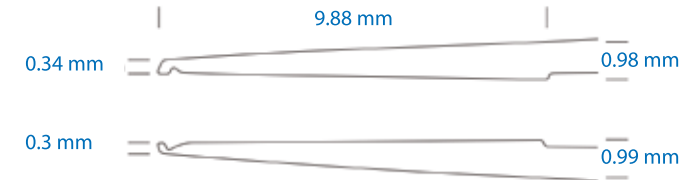

CORNEAL RING FORCEPS INTACS / Pince à anneau intra-cornéen - INTACS / Intacs Pinzette für Cornealen Ring

Length : 8.156 cm
Handle length : 53.79 mm

SR08

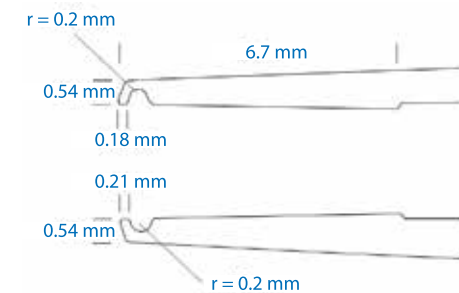

PATON SPATULA & SPOON DOUBLE ENDED / Spatule double de Paton / Paton Spatel und Löffel Zweiseitig

Length : 15.151 cm
Handle length : 71.17 mm
Round bodied
Double ended

SR108

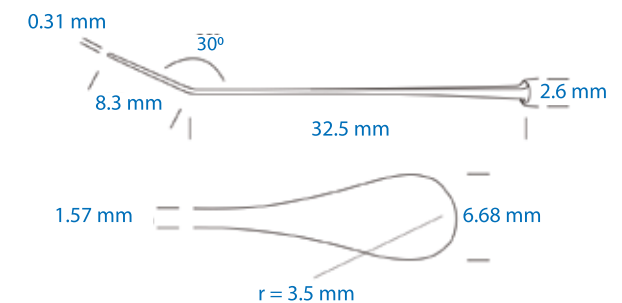

NEORIS POCKETING SPATULA DOUBLE ENDED / Spatule double NEORIS / Neoris Taschenspatel zweiseitig

Overall Length : 118.57 mm
Handle Length : 71 mm

SR12

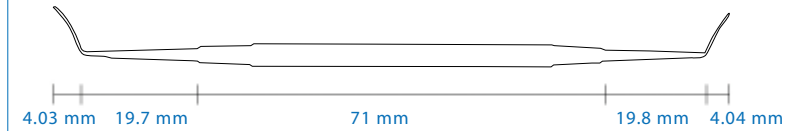

CORNEAL MARKER CAPSULORHEXIS GUIDE / Marqueur cornéen 6mm / Hornhautmarker für Kapsulhorexis

Length : 12 cm
Handle length : 92 mm
6 mm well
Round bodied

SC130

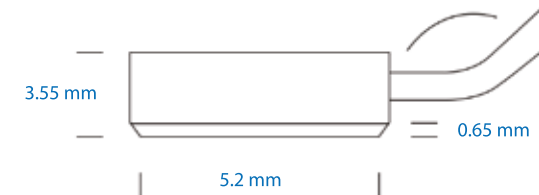

LASIK FLAP-LIFTING FORCEPS / Pince angulée mors long / Lasik Flap Hebepinzette

Handle length : 80 mm
45° angled
11.5mm platform

SR14



CORNEAL SEPARATOR / Séparateur cornéen / Kornea Separator

Length : 11.2 cm
60° Angled

SR70



GENERAL OPHTHALMIC

Ophthalmologie Générale

Allgemeine Ophthalmologie



SG12

THORNTON FIXATION RING SMALL 13 MM

Anneau de fixation de Thornton 13 mm

Thornton Fixationsring klein 13 mm

Length : 13 cm

Handle length : 91 mm

swivel head 11 mm cut out

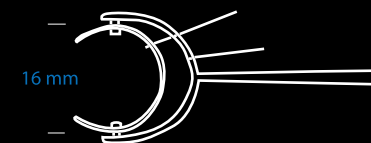

BALL TIP MUSCLE HOOK / Crochet à muscle, point boule / Schielhäkchen, ballförmige Spitze

Length : 10.5 cm
Handle length : 76 mm

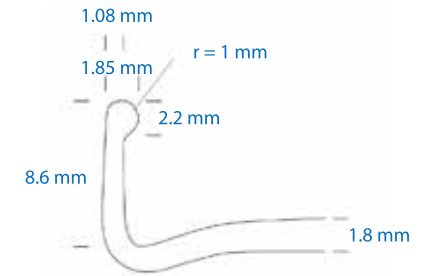

BULLDOG CLIP / Bulldog Clip / Bulldog Clip

Length : 40 mm
Handle length : 25 mm
16 mm clipping platform not on website

SG92

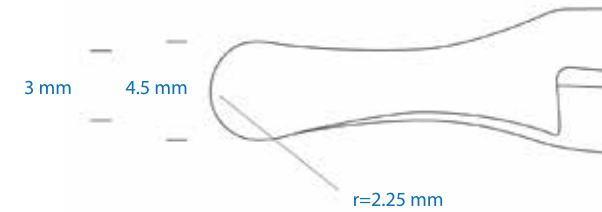

CHAVASSE HOOK / Crochet de Chavasse / Chavasse Häkchen

Length : 13 cm
Handle length : 98 mm
90° angle, curved hooked tip

SC91

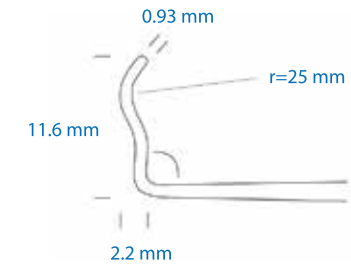

DESMARRES RETRACTOR / Retracteur de Desmarre / Desmarres Retraktor

Length : 14 cm
Handle length : 10 cm

SG20

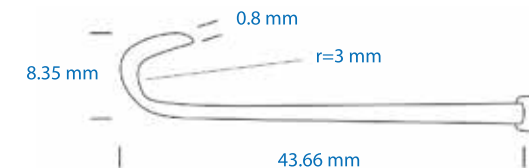

EYELID PLATE / Plaque à paupière de Jaeger / Lidplatte

Length : 90 mm
27 mm end
17 mm end

SG17

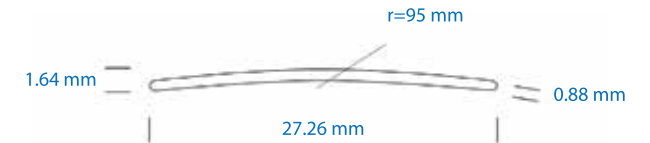

GUTHRIE HOOK / Crochet de Guthrie / Guthrie Häkchen

Length : 12 cm
Handle length: 90 mm
Two pronged hook

SG37

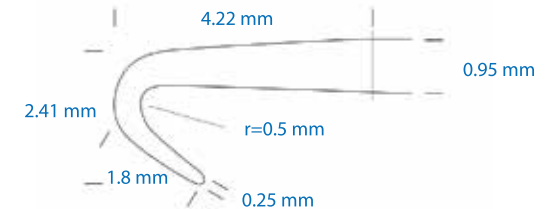

HALSTEAD MOSQUITO FORCEPS STRAIGHT / Pince de Halstead, droite / Halstead Arterienklemme, gerade

Length : 12.5 cm

SG33



JAMESON STRABISMUS HOOK 5 MM / Crochet à strabisme de Jameson / Jameson Schielhaken

Length : 11 cm
Handle length : 83 mm
60° hook with rounded bulbous tip
Extended version 8 mm hook

SG10

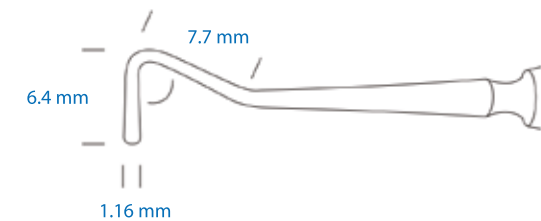

MOSQUITO FORCEPS CURVED / Pince Mosquito, courbe / Mosquito Pinzette, gebogen

Length : 12.5 cm
22 mm serrated clamp area

SG22

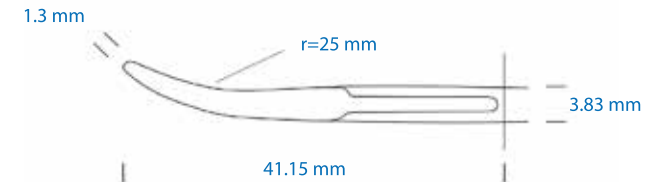

SCLERAL DEPRESSOR BULBOUS END / Dépresseur scléral / Skleral Depressor wulstige Enden

Length : 13 cm
Handle length : 92 mm
2.5 mm 10° angled bulbous end

SC23



SCLERAL DEPRESSOR DOUBLE ENDED / Dépresseur scléral double de Schocket / Skleral Depressor zweiseitig

Length : 13.5 cm
Handle length : 60 mm
6 mm, 2 mm hammer end,
2.5 mm 10° angled bulbous end
Double ended

SC25

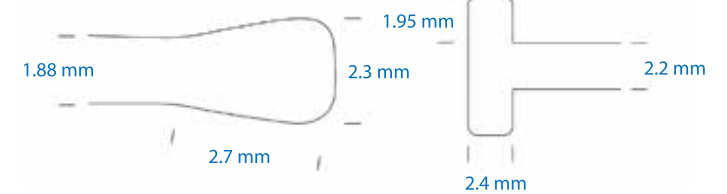

SCLERAL DEPRESSOR HAMMER END / Dépresseur scléral courbe / Skleral Depressor hammerförmiges Ende

Length : 12.5 cm
Handle length : 92 mm
6 mm hammer, 2 mm ends

SC24

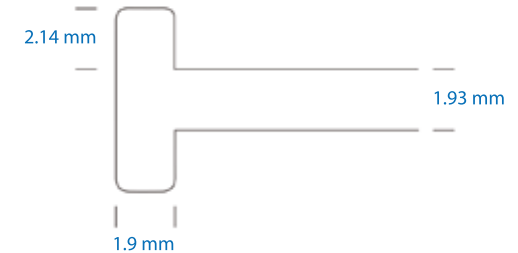

THORNTON FIXATION RING STANDARD 16 MM / Anneau de fixation de Thornton 16mm / Thornton Fixationsring standard 16mm

Length : 13.5 cm
Handle length : 91 mm
swivel head 14 mm cut out

SG13

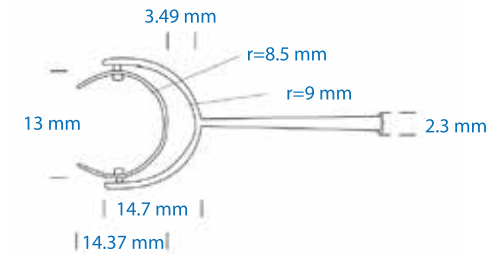

TRABECULECTOMY PUNCH / Punch à trabéculéctomie / Trabekulotomie Stanze

Length : 12 cm
Handle length : 90 mm

SG03

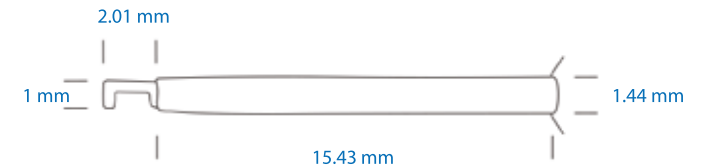

RAMPLEYS SPONGE HOLDING FORCEPS / Pince de Rampley 19 cm / Rampley Tupferpinzette

Overall Length : 190.3 mm
Handle Length : 67.9 mm
All Measurements +/- 0.05 mm

RMPL

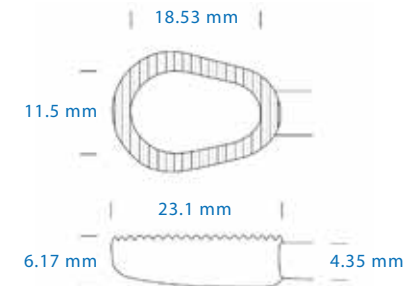

RAMPLEYS SPONGE HOLDING FORCEPS (SHORT) / Pince de Rampley 14 cm / Rampley Tupferpinzette kurz

Overall Length : 141.4 mm
Handle Length : 71.1 mm
All Measurements +/- 0.05 mm

RMPS

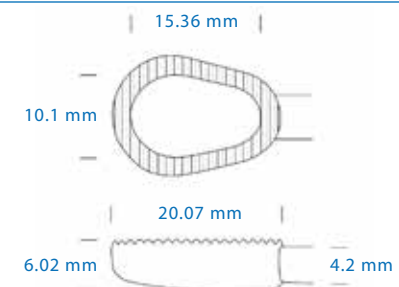

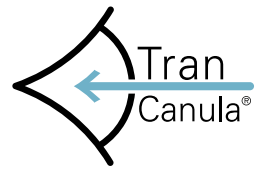

fabrinal
EYE CARE

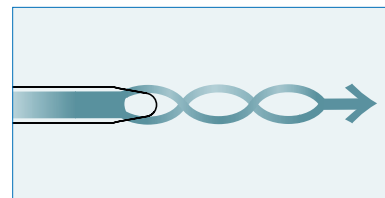
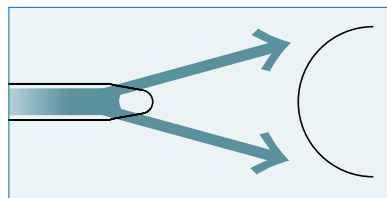
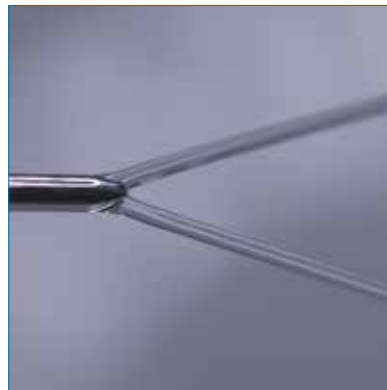

The Tran Canula® is a sterile and single use irrigation cannula used by physician in controlled environment to clear the pseudo-exfoliative particles in the anterior chamber of the eye. Unlike a conventional single jet irrigation cannula, this new instrument is characterized by two distinct water jets separated from each other by a 30° angle. Thanks to the unique design of the cannula and the laws of micro-hydrodynamics, these two independent fluid streams merge into one, more powerful, since they touch an obstacle.

TRAN CANULA®, TC- 01, SPECIFICATIONS

- Reference : TC- 01
- Cannula length : 19 mm
- Radius of curvature : 25 mm
- Outside diameter : 0.8 mm
- Design : Dr. V.T. Tran

TRAN CANULA® PACKAGING

- In a double sterile blister pack ; single use only.
- Packaging : 5 pieces
- 205 x 57 x 45 mm

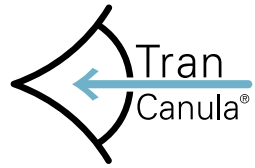

La Tran Canula® est une canule d'irrigation stérile à usage unique utilisée par le médecin dans un environnement contrôlé, pour éliminer les particules pseudo-exfoliatives déposées dans la chambre antérieure de l'œil. Contrairement à une simple canule d'irrigation à jet classique, ce nouvel instrument est caractérisé par deux jets d'eau distincts séparés l'un de l'autre par un angle de 30°. Grâce à sa conception unique et aux lois de la micro-hydrodynamique des fluides, ces deux jets indépendants fusionnent en un seul fuseau liquide, plus puissant, dès lors qu'ils touchent un obstacle.

TRAN CANULA®, TC- 01, SPÉCIFICATIONS

- Référence : TC- 01
- Longueur cannule : 19 mm
- Rayon de courbure : 25 mm
- Diamètre extérieur : 0.8 mm
- Design : Dr. V.T. Tran

TRAN CANULA® PACKAGING

- Sous double blister stérile, à usage unique.
- Emballage : 5 pièces
- 205 x 57 x 45 mm

Tran Canula® ist eine sterile Einweg-Spülkanüle, die in kontrollierter Umgebung von Ärzten angewandt wird, um die pseudoexfoliativen Partikel aus der vorderen Augenkammer zu entfernen.

Im Gegensatz zur herkömmlichen Einzelstrahl-Spülkanüle zeichnet sich dieses neue Instrument durch zwei getrennte Wasserstrahlen aus, die zueinander in einem Winkel von 30° stehen. Dank des einzigartigen Designs der Kanüle und aufgrund der Gesetze der Mikrohydrodynamik verschmelzen diese beiden unabhängigen Flüssigkeitsströme zu einem einzigen stärkeren, sobald sie ein Hindernis berühren.

TRAN CANULA®, TC- 01, CHARAKTERISTIKA

- Kennzeichen : TC- 01
- Kanülenlänge : 19 mm
- Krümmungsradius : 25 mm
- Aussendurchmesser : 0.8 mm
- Entwurf : Dr. V.T. Tran

TRAN CANULA® VERPACKUNG

- In einer doppelten sterilen Sichtverpackung ; zum einmaligen Gebrauch.
- Packung : 5 Stück
- 205 x 57 x 45 mm



CAPSULORHEXIS		
SC33M	MICS CAPSULORHEXIS FORCEPS CROSS ACTION	page 6
SC34M	CAPSULORHEXIS ROUND BODIED CURVED	page 7
SC29M	MICS CAPSULORHEXIS FORCEPS CURVED	page 7
SC134M	MICS CAPSULORHEXIS FORCEPS ROUND BODIED CURVED	page 7
SC133M	MICS CAPSULORHEXIS FORCEPS STRAIGHT	page 7
FORCEPS		
SC59	ADSONS DISSECTION FORCEPS	page 9
SC56	BISHOPS FORCEPS	page 9
SC38	BONN FORCEPS	page 10
SC129	BONN FORCEPS	page 10
SC22	COLIBRI TOOTHED FORCEPS	page 10
SC20	COLIBRI TYING FORCEPS	page 10
SC115	FINE CLAW FORCEPS	page 11
SC55	HOSKINS FORCEPS	page 11
SC116	IRIS FORCEPS	page 11
SC128	IRIS FORCEPS POINTED	page 11
SC117	JAYLES FORCEPS	page 12
SC49	STRAIGHT NOTCHED FORCEPS (HOSKINS)	page 12
SC54	ST. MARTINS FORCEPS	page 12
SC21	STRAIGHT TOOTHED FORCEPS FINE	page 12
SC119	ADSONS FORCEPS	page 13
SC113	ADSONS FORCEPS FINE SERRATED	page 13
SC104	DENIS SCLERECTOMY FORCEPS	page 13
SC58	EPILATION - CILIA FORCEPS	page 13
SC127	EPILATION FORCEPS	page 14
SC60	JEWELLERS FORCEPS	page 14
SA12	MOORFIELDS FORCEPS	page 14
SA17	MOORFIELDS FORCEPS FINE	page 14
SG02	MOSQUITO FORCEPS	page 15
SC112	IOL REMOVAL FORCEPS	page 15
SC51	LENS FOLDING FORCEPS	page 15
SC52	LENS IMPLANTATION FORCEPS	page 15

FORCEPS		
SC73	KELMAN MC PHERSON FORCEPS	page 16
SC72	MC PHERSON TYING FORCEPS	page 16
SC50	CURVED NOTCHED FORCEPS	page 16
SC19	STRAIGHT TYING FORCEPS	page 16
SC120	SUTURE REMOVAL FORCEPS CURVED	page 17
SC105	TROUTMAN TYING FORCEPS CURVED	page 17
SC71	STRAIGHT TYING FORCEPS	page 17
SC99	LINDGREN FORCEPS	page 17
MANIPULATORS & CHOPPERS		
SC47	DRYSDALE NUCLEUS SPATULA	page 18
SC39	CHOPPER AND DIALLER	page 19
SC97	DENIS CLEAVER	page 19
SC45	GREENS CHOPPER	page 19
SC100	GOVAN MANIPULATOR	page 19
SC102	GOVAN MANIPULATOR AND PHACO CHOPPER	page 20
SC63	IRIS REPOSITOR	page 20
SC90	JONES CHOPPER	page 20
SC44	KOCH CHOPPER	page 20
SC143	KOCH PHACO SPATULA	page 21
SG15	KUGLEN HOOK	page 21
SC106	LE BUISSON MANIPULATOR	page 21
SC46	LENS DIALER (SINSKEY HOOK)	page 21
SC146	LESTER HOOK	page 22
SC147	PHACO CHOPPER AND MUSHROOM MANIPULATOR DOUBLE ENDED	page 22
SC43	PHACO CHOPPER	page 22
SC42	PHACO CHOPPER CLAW	page 22
SC101	PISACANO ROTATOR AND NEUHANN MANIPULATOR DOUBLE END	page 23
SC144	SINSKEY HOOK AND GOVAN MANIPULATOR DOUBLE ENDED	page 23
SC48	MUSHROOM NUCLEUS MANIPULATOR	page 23
SC41	Y SHAPED NUCLEUS ROTATOR	page 23

SPECULUMS		
SC01	BROAD GAUGE WIRE SPECULUM	page 25
SC07	CLOSED LOOP WIDE SPECULUM	page 25
SC124	HEAVY GAUGE WIRE SPECULUM OPEN LOOP	page 25
SC09	KRATZ BARRAQUER CLOSED LOOP	page 25
SC132	KRATZ BARRAQUER CLOSED LOOP SPECULUM	page 26
SC11	KRATZ BARRAQUER WIRE SPECULUM OPEN LOOP	page 26
SC107	KRATZ OPEN LOOP WIRE SPECULUM (BLUE)	page 26
SC13	KRATZ CLOSED LOOP SPECULUM	page 26
SC05	KRATZ SOLID BLADED WIRE SPECULUM	page 27
SC11P	PLASTIC BLADED WIRE SPECULUM	page 27
SC12	TEMPORAL SPECULUM	page 27
SC03	BANGERTER ADULT SPECULUM	page 27
SR10	BLADED ADJUSTABLE SPECULUM	page 28
SC126	CLARKE SPECULUM	page 28
SR11	KRATZ SCREW ADJUSTABLE WIRE SPECULUM OPEN LOOP	page 28
SC08	SOLID BLADED SCREW ADJUSTABLE SPECULUM	page 28
SR11P	PLASTIC SCREW ADJUSTABLE OPEN LOOP WIRE SPECULUM	page 29
SR10P	PLASTIC SCREW BLADED SPECULUM	page 29
SC10	KRATZ PAEDIATRIC CLOSED LOOP 10 MM SPECULUM	page 30
SC103	NEONATE PAEDIATRIC SPECULUM	page 30
SC15	NEONATE 4 MM SPECULUM	page 30
SC14	PAEDIATRIC 6 MM SPECULUM	page 30
SCISSORS		
SC82	CASTROVIEJO CORNEAL SCISSORS RIGHT	page 32
SC83	CASTROVIEJO CORNEAL SCISSORS LEFT	page 32
SC110	CASTROVIEJO SCISSORS STRAIGHT & ROUND	page 32
SC80	ONG IRIS SCISSORS	page 32
SC109	OSHER SCISSORS	page 32
SA13	STALLARD CORNEAL SCISSORS	page 33
SC81	VANNAS SCISSORS	page 33
SC108	VANNAS SCISSORS CURVED	page 33
SA11	WESTCOTT CONJUNCTIVAL SCISSORS	page 33

SCISSORS		
SA14	WESCOTT SCISSORS DOLPHIN NOSE	page 34
SC111	CASTROVIEJO SCISSORS STRAIGHT	page 34
SG35	DRESSING SCISSORS	page 34
SG34	ENUCLEATION SCISSORS	page 34
SG14	GENERAL LONG HANDLE SCISSORS BLUNT END	page 35
SG06	GENERAL SCISSORS BLUNT END	page 35
SG01	GENERAL SCISSORS SHARP POINTED	page 35
SG30	METZENBAUM SCISSORS CURVED POINTED	page 35
SG07	STRABISMUS SCISSORS	page 36
SG23	STEVENS SCISSORS CURVED	page 36
SG96	IRIS SCISSORS	page 36
MEASURERS & MARKERS		
SG04P	BRAUNSTEIN CALIPER PLASTIC	page 38
SG04	BRAUNSTEIN FIXED CALIPER 1.8 MM THICKNESS	page 38
SG05	CASTROVIEJO ADJUSTABLE CALIPER	page 38
SG93	HELVESTON RULER	page 38
SC64	INJECTION MARKER	page 39
SC65	MENDEZ GAUGE	page 39
SG19	SCLERAL MARKER ROUND BODIED DOUBLE ENDED	page 39
SR72	8 LINE CORNEAL MARKER	page 39
CURETTES & CLAMPS		
CS03	CHALAZION CLAMP MEDIUM	page 40
CR01	CURETTE SMALL	page 41
CR02	CURETTE MEDIUM	page 41
CR03	CURETTE LARGE	page 41
CR05	CURETTE DOUBLE ENDED	page 41
CS01	CHALAZION CLAMP SMALL	page 41
CS02	CHALAZION CLAMP LARGE	page 41
NEEDLE HOLDERS		
SC61	SUTURE NEEDLE HOLDER CURVED	page 42
SC142	BARRAQUER NEEDLE HOLDER CURVED	page 43
SC118	CASTROVIEJO NEEDLE HOLDER LOCKING	page 43

NEEDLE HOLDERS		
SC62	NEEDLE HOLDER BLUNT LOCK	page 43
SC114	NEEDLE HOLDER CURVED	page 43
LACRIMAL		
PD05	BOWMANS PROBE SIZE 00-0 DOUBLE ENDED	page 45
PD06	BOWMANS PROBE SIZE 000-00 DOUBLE ENDED	page 45
PD08	LACRIMAL PROBE	page 45
PD02	PUNCTAL DILATOR BLUNT	page 45
PD03	PUNCTAL DILATOR DOUBLE ENDED	page 46
PD01	PUNCTAL DILATOR SHARP	page 46
PD04	PUNCTAL DILATOR SHORT	page 46
PD07	PUNCTAL DILATOR & LACRIMAL PROBE DOUBLE ENDED	page 46
CORNEAL & REFRACTIVE		
SR12	NEORIS POCKETING SPATULA DOUBLE ENDED	page 47
SR109	DMEK BERNHEIM HOOK	page 48
SR100	CORNEAL EPITHELIUM SPATULA ROUND	page 48
SR40	CK LASIK MARKER	page 48
SR51	EPI PEELER	page 48
SR61	EPI PEELER RECTANGLE SHAPED	page 49
SR60	EPI PEELER D SHAPED	page 49
SR34	INTRA LASIK FLAP SEPARATOR	page 49
SR102	KOCABA DMEK FORCEPS	page 49
SR41	ALCOHOL WELL VARIOUS SIZES	page 50
SR21	LASIK CORNEAL MARKER	page 50
SR31	LASIK FLAP ELEVATOR	page 50
SR71	LASIK FLAP FORCEPS	page 50
SR103	LASIK FLAP SEPARATOR AND ELEVATOR DOUBLE END	page 51
SR104	LENTICULE SEPARATOR HOOK AND SPATULA DOUBLE END	page 51
SR101	S MARKER	page 51
SR105	TREPHINE VARIOUS SIZES	page 51
SR02	LASIK FEMTO SEPARATOR AND ELEVATOR DOUBLE ENDED	page 52
SR03	SINSKEY AND REVERSE SINSKEY HOOK	page 52
SR04	CORNEAL RING PUSHER	page 52

CORNEAL & REFRACTIVE		
SR05	CORNEAL RING POCKETING HOOK	page 52
SR06	CORNEAL RING POCKET SPREADER	page 53
SR07	CORNEAL RING FORCEPS KERARING	page 53
SR08	CORNEAL RING FORCEPS INTACS	page 53
SR108	PATON SPATULA & SPOON DOUBLE ENDED	page 53
SC130	CORNEAL MARKER CAPSULORHEXIS GUIDE	page 54
SR14	LASIK FLAP-LIFTING FORCEPS	page 54
SR70	CORNEAL SEPARATOR	page 54
GENERAL OPHTHALMIC		
SG12	THORNTON FIXATION RING SMALL 13 MM	page 55
SG32	BALL TIP MUSCLE HOOK	page 56
SG92	BULLDOG CLIP	page 56
SC91	CHAVASSE HOOK	page 56
SG20	DESMARRES RETRACTOR	page 56
SG17	EYELID PLATE	page 57
SG37	GUTHRIE HOOK	page 57
SG33	HALSTEAD MOSQUITO FORCEPS STRAIGHT	page 57
SG10	JAMESON STRABISMUS HOOK 5 MM	page 57
SG22	MOSQUITO FORCEPS CURVED	page 58
SC23	SCLERAL DEPRESSOR BULBOUS END	page 58
SC25	SCLERAL DEPRESSOR DOUBLE ENDED	page 58
SC24	SCLERAL DEPRESSOR HAMMER END	page 58
SG13	THORNTON FIXATION RING STANDARD 16 MM	page 59
SG03	TRABECULECTOMY PUNCH	page 59
RMPL	RAMPLEYS SPONGE HOLDING FORCEPS	page 59
RMPS	RAMPLEYS SPONGE HOLDING FORCEPS (SHORT)	page 59
TRAN CANULA		
TC-01	TRAN CANULA	page 60

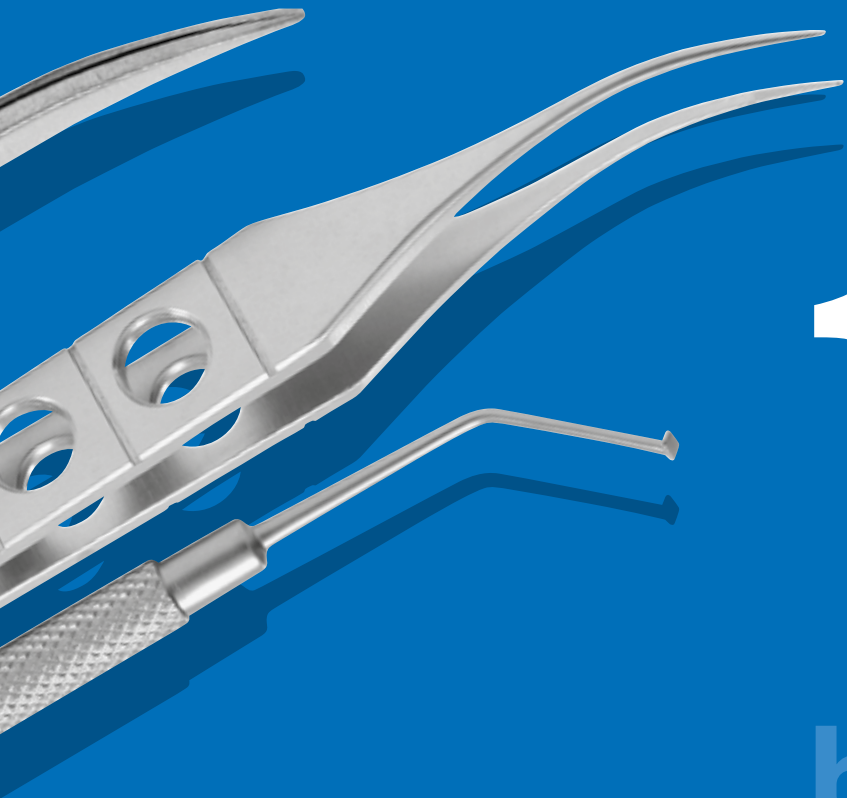

1 **J** **JUST**
ONE
USE

by **Surgitrac**
Europe

16A RUE DE JOUANET
35700 RENNES
Tel +33(0)970.460.790.
.....
www.just-one-use.com