

FT 620B VHF SSB TRANSCEIVER



GENERAL DESCRIPTION

The model FT 620B VHF SSB transceiver is specifically designed to provide a high performance, compact transceiver for amateur VHF SSB, AM and CW service, base or mobile.

The FT 620B is completely solid state with provision for VFO operation covering entire 6 meter amateur bands in eight segments. In addition to the VFO operation, 4 crystal controlled channels are provided. Advanced design features include noise blanker, squelch circuit, CW break in and AFP (automatic final protection) circuit to prevent damage to the transistors in case of high antenna VSWR.

The FT 620B is self-contained, requiring only an antenna and power source for home or mobile operation. The FT 620B may be operated from 100/110/117/200/220 or 234 volts AC (normally supplied wired for 117 volts), or 13.5 volts DC. Two power cables are supplied with the transceiver. Selection of AC or DC power source is automatically made when the proper power cable is connected to the transceiver.

The FT 620B VHF transceiver is supplied complete with cables, connectors, microphone and accessories, as shown below.

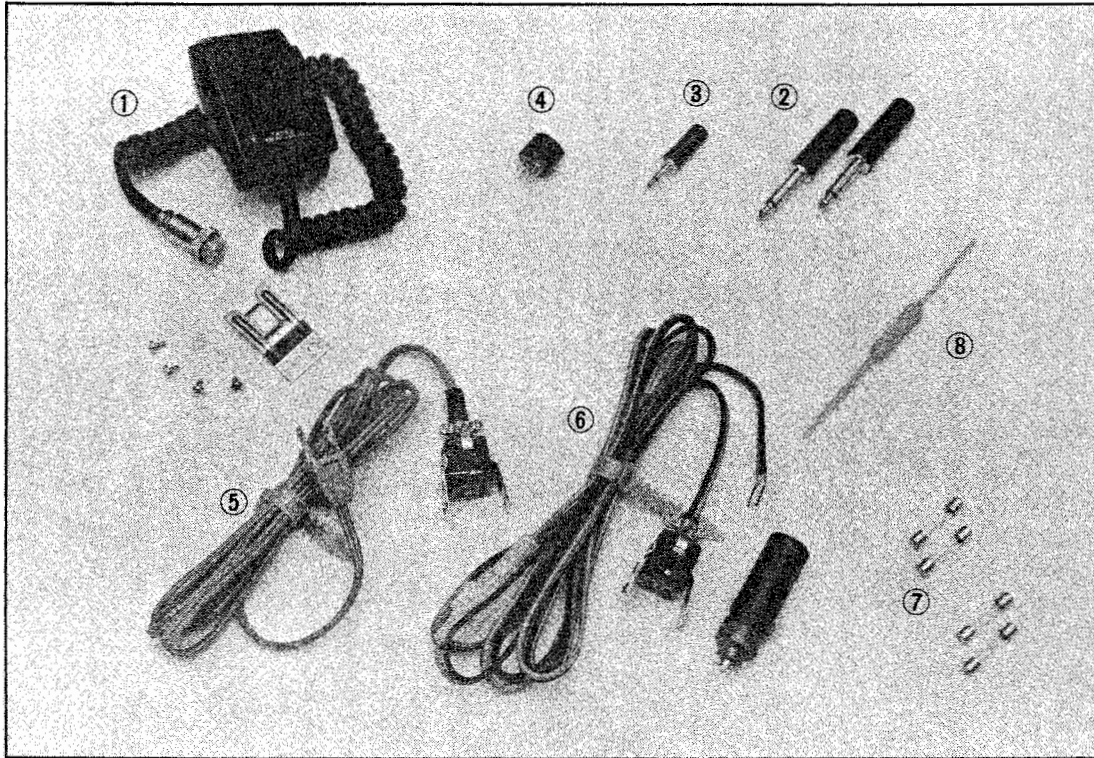

Figure 1

- (1) Dynamic push-to-talk microphone YM-86 with retractable coiled cord.
- (2) Phone plug for headphone or key.
- (3) Miniature phone plug for external speaker.
- (4) 7-pin male connector for accessory receptacle.
- (5) AC power cable.
- (6) DC power cable.
- (7) Spare fuses, 2A for AC, 3A for DC operation.
- (8) Alignment tool.

SPECIFICATIONS

GENERAL

Frequency Range	50.0 - 50.5 MHz, 50.5 - 51.0 MHz, 51.0 - 51.5 MHz, 51.5 - 52.0 MHz, 52.0 - 52.5 MHz, 52.5 - 53.0 MHz, 53.0 - 53.5 MHz, 53.5 - 54.0 MHz. (52.0 - 54.0 MHz crystals are options.)
Emission	SSB (USB or LSB selectable), AM, and CW.
Power Requirement	AC 100/110/117/200/220/234 volts. 50/60 Hz. DC 12.5 - 14 volts, negative ground. (13.5 volts DC nominal)
Power Consumption	AC Receive 16VA. Transmit 60VA. DC Receive 0.3A. Transmit 2A.
Speaker	Internal dynamic speaker. 10 cm diameter with provision for connecting external 4 ohm dynamic speaker.
Microphone	Dynamic push-to-talk microphone with retractable coiled cord, 10 kilo ohm impedance.
Size	280(W), 125(H), 295(D) m/m.
Weight	8 kg. approx.

TRANSMITTER

Final Input	SSB, CW 20 watts DC. AM 8 watts DC.
Carrier Suppression	40 dB or better.
Unwanted Sideband Suppression ... 40 dB or better.	

Spurious Radiation 60 dB below carrier.
Frequency Response 300 - 2700 Hz within ± 3 dB.
Antenna Impedance 50 ohms unbalanced.

RECEIVER

Sensitivity SSB Less than 0.5 uV input for 10 dB
STN/N.
AM Less than 1 uV input for 10 dB
STN/N.
Selectivity SSB 2.5 kHz at -6 dB.
4.1 kHz at -60 dB.
AM 6 kHz at -6 dB.
10 kHz at -60 dB.
(with optional AM filter)
Image Rejection 60 dB or better.
Audio Output 2.0 watts at 10% distortion

SEMICONDUCTORS COMPLEMENT

TRANSISTOR

2SC372Y	20	2SC1216	1
2SC373	1	2SC1306	1
2SC710D	3	2SC1307	1
2SC735Y	1	2N3055	1
2SC784R	6	2SD313E	2
2SC828Q	2		

FET

2SK19	8
3SK40M	3

INTEGRATED CIRCUIT

AN214	1	TA7045M	1
SN7490N	1		

SCR

CW01B	1
-------	---

DIODE

1S2236	1	DS130ND	1
1S188FM	9	KBL02	1
1S1007	7	V06B	4
1S1209	2	WZ061	1
1S1555	6	WZ090	2
1S330	1	WZ110	2

INSTALLATION

GENERAL

The transceiver is designed to provide a complete single unit installation for fixed, portable, or mobile operation. Two prewired plugs are supplied with the unit for AC or DC power source. This system provides the flexibility required for various installation and allows rapid change from base to mobile operation.

BASE STATION INSTALLATION

The transceiver is designed for use in many countries in the world using supply voltage that may differ from the operator's local supply voltage. Therefore, prior to connecting the AC cable to the power outlet, be sure that the voltage marked on the rear of the transceiver agrees with the local AC supply voltage.

C A U T I O N =====

PERMANENT DAMAGE WILL RESULT IF IMPROPER AC SUPPLY VOLTAGE IS APPLIED TO THE TRANSCEIVER.

The transceiver should be connected to a good ground. The ground lead should be as short as possible and connected to the terminal marked GND on the rear panel.

MOBILE INSTALLATION

The transceiver will operate satisfactorily from any 12 volt negative ground battery source by connecting the DC power cable to the rear panel receptacle.

For under-dash mounting, a mounting bracket is available from your local dealer. A location should be selected clear of heater ducts. No special mounting precautions be observed if adequate ventilation space is available. Never stack other units above or below the cabinet since the accumulated heat from both units could cause permanent damage.

The transceiver requires an average of 2 amps on transmit. The fuse in the DC power cable should be rated at 3 amps. The power cable may be plugged directly into the vehicle's cigar lighter receptacle for casual operation if desired. For permanent installation, the lighter plug may be removed and the leads routed directly to the battery (RED positive, BLACK negative or ground), or to the nearest termination of the battery, i. e. fuse block, etc. If it is necessary to extend the power cable, use #16 AWG insulated copper wire and do not make the leads any longer than required, otherwise excessive voltage drop may occur.

CAUTION
=====

BEFORE CONNECTING THE POWER CABLE TO THE TRANSCEIVER, CHECK THE BATTERY VOLTAGE WITH THE ENGINE RUNNING AND THE BATTERY CHARGING. IF THE VOLTAGE EXCEEDS 14.5 VOLTS DC, THE REGULATOR SHOULD BE READJUSTED SO THAT THE HIGHEST CHARGING VOLTAGE DOES NOT EXCEED 14.5 VOLTS. ALSO BE SURE TO OBSERVE PROPER POLARITY WHEN MAKING BATTERY CONNECTIONS. REVERSED CONNECTION COULD DAMAGE THE TRANSCEIVER PERMANENTLY.

ANTENNA

CAUTION
=====

NEVER TRANSMIT WITHOUT HAVING PROPER ANTENNA OR DUMMY LOAD CONNECTED TO THE TRANSCEIVER.

The transceiver is designed for use with resonant antenna having an impedance of 50 ohm resistive load. The antenna is usually the most critical part of a station installation. Results both in receiving and transmitting will depend on how well the antenna is installed and adjusted. Any of common antenna systems, such as dipole, cubical quad, Yagi beam, designed for use on the 6 meter amateur bands may be used with the transceiver, provided the input impedance of the antenna system is 50 ohms.

The antenna should always be as high and in the clear as possible. Also, in mobile installation, it is advisable to locate the antenna as far from the engine as practical to minimize ignition noise pick up. In all installations, ensure that the antenna VSWR is less than 1.5 : 1.

For mobile installation, the most popular antenna is vertical type, either a quarter wave length whip with unity gain, or a 5/8 wave length whip affording approximately 3.5 dB gain.

To minimize loss in the antenna system, use the shortest possible length of coaxial cable, avoiding any sharp angles or kinks. Use type RG-8U cable if the transmission line length exceeds 25 feet. The RG-58U cable is suitable for shorter length.

CONTROLS AND SWITCHES

The transceiver is specifically designed for ease of operation and versatility. All controls have been preset at the factory. Be sure you thoroughly understand the function of each control before operating the transceiver.

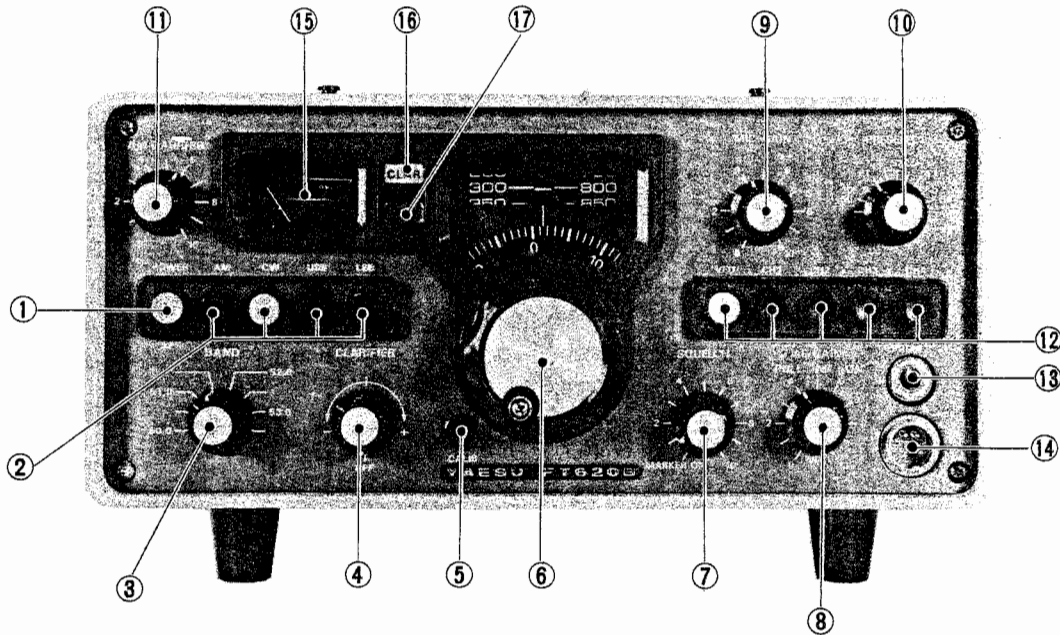

Figure 2. Front Panel

- | | |
|-------------------|---|
| (1) POWER | - Main switch. When pressed first, turns the transceiver ON for both AC and DC, and when pressed second, turns the transceiver OFF. |
| (2) MODE SELECTOR | - Selects the mode of operation; AM, CW, USB or LSB. |
| (3) BAND | - Selects the desired band in 50 - 54 MHz split into eight 500 kHz segments. |
| (4) CLARIFIER | - Provides a means of turning the receiver frequency a few kHz to either side of the transmitting frequency. Thus it is possible to set the pitch of the voice you are receiving to the most readable point without affecting your transmitting |

frequency. The receiver frequency may be locked to transmitting frequency at OFF position.

- (5) CALIB - Is used to calibrate the dial readout with 100 kHz marker signal.
- (6) TUNING KNOB - The tuning knob (VFO) directly below the main dial window in combination with the band switch. Determines actual operating frequency.
- (7) SQUELCH - Adjusts the receiver squelch threshold sensitivity. At fully counter-clockwise position, the internal 1 MHz marker generator is on for the dial calibration.
- (8) AF GAIN - Adjusts the audio output level at the speaker and phone jack. Clockwise rotation increases the audio output. When pulled, the noise blanker works.
- (9) MIC GAIN - Adjusts the audio level from the microphone amplifier stages. Clockwise rotation increases the microphone gain.
- (10) PRESELECTOR - Tunes the signal circuit for both transmit and receive.
- (11) AM CARRIER - Controls carrier level for AM mode operation.
- (12) VFO SELECT - Selects VFO or four fixed crystal oscillator positions. Normal operation by VFO requires that VFO push button is depressed.
- (13) PHONES - Headphone may be inserted in this jack. The internal speaker is disconnected when the plug is installed.
- (14) MIC - Microphone jack.
- (15) METER - Indicates signal strength and a relative power output in transmit.
- (16) CLAR - With the clarifier ON, this indicator lights up.
- (17) FIX - Lights up when the crystal controlled channel is selected instead of VFO control.

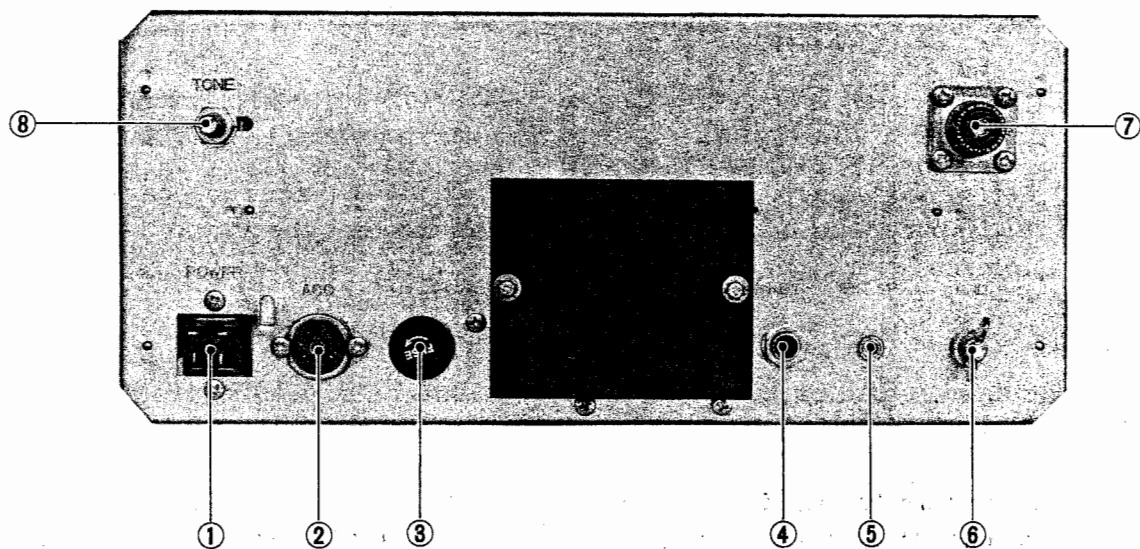

Figure 3. Rear Panel

- | | | |
|------------|---|--|
| (1) POWER | - | Power receptacle. Both AC and DC cables are supplied. |
| (2) ACC | - | Accessory socket. Provides access to transceiver operating voltages and relay contacts. |
| (3) FUSE | - | Fuse holder requires 1 amp for AC operation. |
| (4) KEY | - | Key jack for code operation. |
| (5) EXT SP | - | Audio output is provided at this jack for an external speaker. Output impedance is 4 ohms. |
| (6) GND | - | Ground connection. |
| (7) ANT | - | Coaxial connector for antenna. |
| (8) TONE | - | Sidetone output level adjustment for CW operation. |

OPERATION

INITIAL CHECK

Before connecting the transceiver to a power source, carefully examine the unit for any visible damage. Ensure that the voltage specification marked on the rear panel matches the supply voltage.

FREQUENCY SELECTION

The main tuning dial has two colored scales, white and green, for proper frequency readout with the setting of BAND switch.

The operator reads the white scale for the BAND switch setting of 50.0, 51.0, 52.0 and 53.0 MHz, and the green scale for 50.5, 51.5, 52.5 and 53.5 MHz.

The sub-dial in window is marked in 1 kHz increments and provides accurate setting of the operating frequency. The setting shown in the example, Fig. 4, would then be 51.1325 MHz when the BAND switch is set to 51.0 MHz. When the BAND switch is set to 51.5 MHz, then the above setting would be 51.6325 MHz.

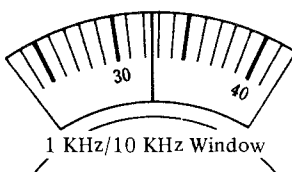
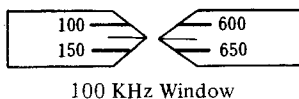

Figure 4

RECEIVER CALIBRATION

(1) Preset the controls and switches as follows:

POWER	:	OFF
MODE	:	Desired mode
BAND	:	Desired band
CLARIFIER	:	OFF
SQUELCH	:	Position 1
AF GAIN	:	Position 5
SELECT SW	:	VFO
PRESELECTOR	:	Operating frequency position
MAIN TUNING KNOB	:	100 kHz point

- (2) Press the POWER switch. Meter and dial lamps will light and noise or signal may be heard from the speaker.
- (3) To calibrate, set the TUNING control to the 100 kHz point in the dial nearest the desired operating frequency. Rotate the SQUELCH control fully counter-clockwise position to switch the 1 MHz calibrator on. Set the sub-dial to zero position. Push down the CALIB knob under the main tuning knob and zero beat with the main tuning knob against the 100 kHz marker signal. Depress the CALIB knob.

NOTE : Marker unit is an option and not supplied with the transceiver.

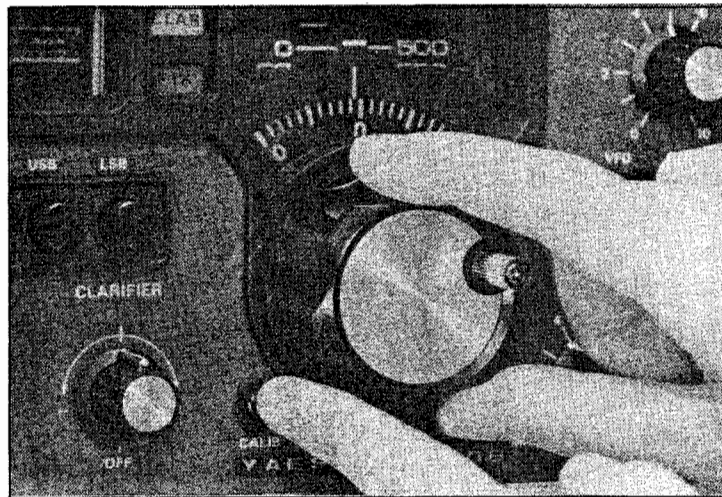

Figure 5

RECEIVE

Connect an antenna to the ANT connector on the rear panel. Tune the transceiver to a desired signal. Depress the MODE switch to the desired mode of operation. Tune the PRESELECTOR for maximum S-meter reading. Adjust the AF GAIN for audible level. When the AUDIO GAIN control is pulled, the noise blanker is placed in the circuit for elimination of noise pulses caused by auto ignition. The CLARIFIER may be used to set the pitch of the voice you are receiving to the most readable point without affecting your transmitting frequency. Its use is particularly valuable in "net" operation when several participants may be transmitting slightly off frequency. The CLARIFIER control may be switched off and the receiver frequency locked to the transmitting frequency by setting the CLARIFIER control to the OFF position. Normally, you will want to keep the CLARIFIER in the OFF position until the initial contact is made. The CLARIFIER control may then be used to zero-in and correct any drift on the received signal.

TRANSMIT

C A U T I O N =====

NEVER TRANSMIT WITHOUT HAVING PROPER ANTENNA OR DUMMY LOAD CONNECTED TO THE TRANSCEIVER.

1. SSB Operation

- (1) Connect a microphone to the MIC jack on the front panel.
- (2) Press a desired mode switch, LSB or USB.
- (3) Set the MIC GAIN control to 12 o'clock position.
- (4) Press the push-to-talk switch on the microphone and speak normally into the microphone.
- (5) The meter shows the modulated output power and meter deflection corresponds to the strength of the audio speech.
- (6) When the push-to-talk switch is released, the transceiver reverts to the receive mode.

C A U T I O N =====

EXCESSIVE MIC GAIN WILL CAUSE DISTORTION ON TRANSMITTED SIGNAL.

2. AM Operation

- (1) Press the AM mode switch.
- (2) Set the MIC GAIN control to zero position.
- (3) Press the push-to-talk switch on the microphone.
- (4) Adjust the AM CARRIER control on the front panel until the meter indicates 1/5 of the maximum meter deflection available for CW transmission.

- (5) Advance the MIC GAIN control until the meter indicates very slight movement with voice peaks while speaking normally into the microphone.

3. CW Operation

- (1) Connect a key to the KEY jack on the rear panel.
- (2) Press the CW mode switch. The transceiver is now ready for code transmission. With key down, the meter will indicate 8.
- (3) With key up, the receiver will recover automatically. The relay hold time may be adjusted by VR902 on the TONE unit board under the chassis.

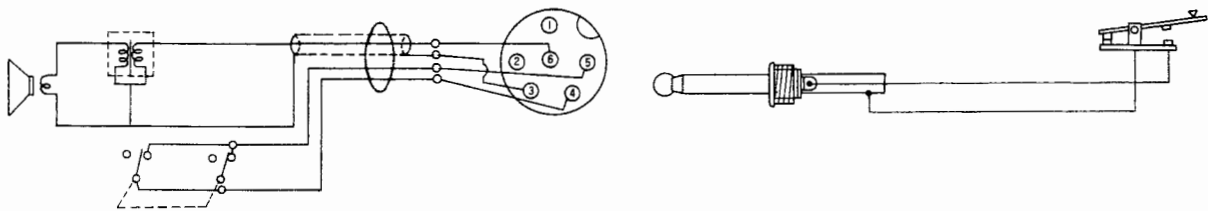
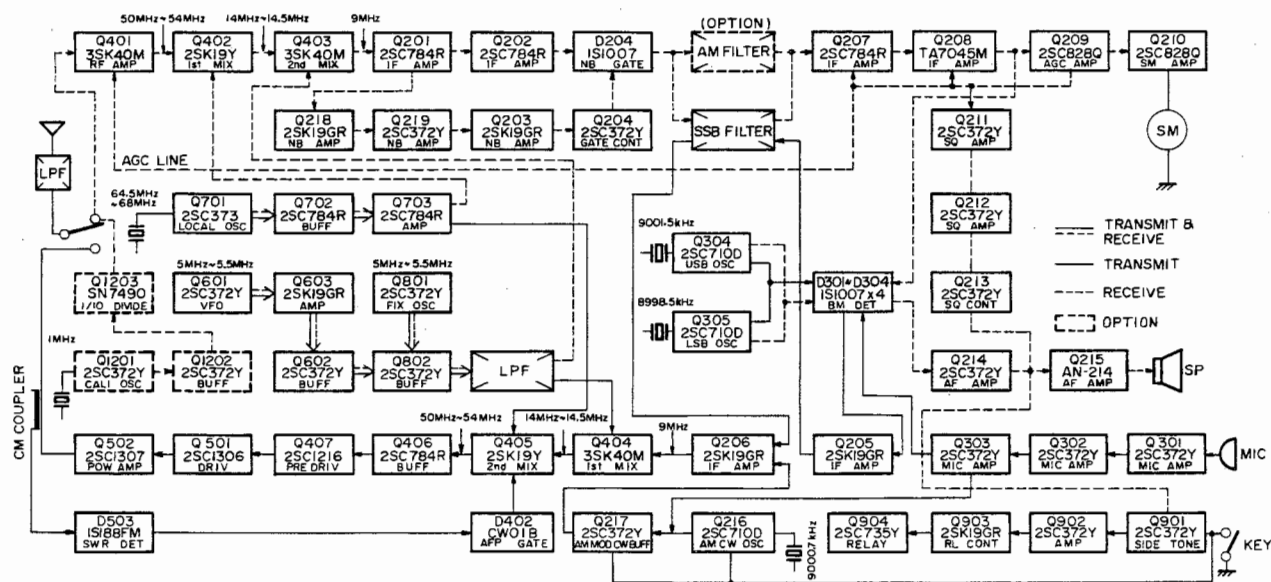

Figure 6. Key and Microphone Connections

CIRCUIT DESCRIPTION

The block diagram and the circuit description will provide you with a better understanding of this transceiver.

FT 620B BLOCK DIAGRAM



RECEIVER SIGNAL PASS

Signal from the antenna is fed to the first gate of Q401, 3SK40M field effect transistor through low pass filter, antenna relay and IF trap. The AGC (automatic gain control) voltage is applied to the second gate of Q401. Amplified signal output from the Q401 is then coupled to the gate of Q402, 2SC784R, first mixer where the incoming signal is mixed with a signal from the first local oscillator. The signal is converted to 14 - 14.5 MHz first IF signal. The first IF signal is applied to the first gate of Q403, 3SK40M, the second mixer. The VFO signal is applied to the second gate of Q403 where the first IF signal is converted to 9 MHz second IF signal.

The second IF signal is amplified by Q201 and Q202, 2SC784R, and fed to the crystal filter XF-90A through noise blanker gate diode D204, 1S1007. The 6 kHz AM filter, XF-90B, is an optional feature available at additional cost. Diode switch is used to select the filter. Without the optional AM filter, all signals are passed through SSB filter.

The signal passing the crystal filter is then amplified by Q207, 2SC784R, and Q206, TA7045M. For SSB and CW, the amplified signal is coupled to the demodulator which is used as modulator in transmit. For AM, the signal is applied to D211, 1S188FM, detector diode. The carrier oscillator oscillates either 8998.5 kHz for LSB or 9001.5 kHz for USB depending upon whether Q305, 2SC710D, or Q304, 2SC710D, is selected by the mode switch. The mode switch disconnects the emitter circuit of either transistor when not in use.

The output from the oscillator is fed to the balanced demodulator. These crystal frequencies are matched to the bandpass characteristics of the crystal filter. The 9001.5 kHz output is also used as BFO voltage for the CW reception.

Demodulated signal is fed to the base Q214, 2SC372Y, audio voltage amplifier through the mode switch and audio gain control potentiometer. The amplified signal is then fed to Q215, AN214, audio power amplifier. Q215 delivers 3.5 watt output to the speaker.

TRANSMITTER SIGNAL PASS

Speech from the microphone is fed to the first mic amplifier Q301, 2SC372Y. Input impedance of the microphone amplifier is 50 kilo ohms. The signal controlled in amplitude by the MIC GAIN control is amplified by the second mic amplifier Q302, 2SC372Y, and applied to the emitter follower Q303, 2SC372Y, to be delivered to the modulator.

For AM operation, the signal is fed directly to the modulator Q217, 2SC372Y. For SSB operation, the signal is fed to the balanced modulator through relay contacts. For CW operation, the output of the microphone amplifier is grounded.

The carrier oscillator oscillates either 8998.5 kHz for LSB or 9001.5 kHz for USB depending upon whether Q304, 2SC710D, or Q305, 2SC710D, is selected by the mode switch. The output from the oscillator is fed to the balanced modulator. These crystal frequencies are matched to the characteristics of the crystal filter to place the carrier frequency approximately 25 dB down on the skirt of the filter response.

The modulated double sideband signal is amplified by the first IF amplifier Q205, 2SK19GR, and then fed to the crystal filter, XF-202, where unwanted sideband is filtered. The single sideband signal is then amplified by the second IF amplifier Q206, 2SK19GR.

For CW and AM, a separate oscillator Q216, 2SC710D, oscillates 9000.7 kHz carrier signal. This signal is fed to the AM modulator Q217, 2SC372Y, which works as a buffer amplifier for CW operation.

The output signal (9 MHz) from Q206 or Q217 is fed to the first gate of the transmitter first mixer Q404, 3SK40M, where the signal is converted into 14 - 14.5 MHz IF signal with the VFO signal applied to the second gate of Q404.

The 14 - 14.5 MHz IF signal is then fed to the transmitter second mixer Q405, 2SK19Y, and converted into the transmitting signal. This transmitting signal is applied to the four stage amplifier chain Q406, 2SC784R, Q407, 2SC1216, Q501, 2SC1306, and Q502, 2SC1307. The amplified signal is fed to the antenna connector through antenna change over relay and a low pass filter.

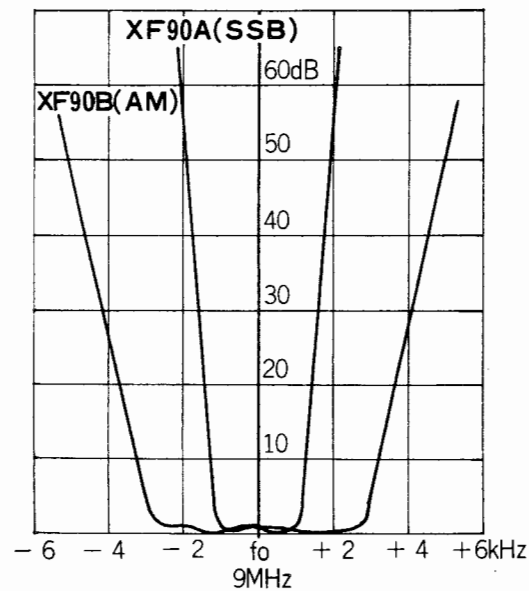

Characteristics of Crystal Filters

Figure 6

COMMON CIRCUIT

As described in the previous pages, the carrier oscillator, modulator and filter are used in common for transmitting and receiving. The following circuits are also used in common for transmitter and receiver.

1. Heterodyne Crystal Oscillator Circuit

Crystal controlled oscillator Q701, 2SC373, oscillates the heterodyne local signal for receiver first mixer and transmitter second mixer. One of eight crystals is selected by the BAND switch to cover 500 kHz segment. The output from the oscillator is fed to the source of Q402 and Q405 through an output coil L703.

2. VFO and FIX Oscillator Circuit

The VFO signal is generated by Q601, 2SC372Y, and fed to the buffers Q602, 2SC372Y, Q603, 2SK19GR, and Q802, 2SC372Y, which provide isolation and amplification of the VFO signal. The VFO oscillation frequency is 5,000 - 5,500 kHz and covers tunable IF range of 500 kHz. Varactor diode D601, 1S2236, is connected into the circuit by the clarifier switch, and this diode is used to shift the VFO frequency when the operating mode is changed.

In addition to the normal VFO operation, one of four crystals may be selected for crystal controlled operation by the CH1 - CH4 push button switch. For oscillator, Q801, 2SC372Y, is used and its output is fed to a buffer amplifier Q802, 2SC372Y. The crystal frequency may be corrected by series connected trimmer capacitors TC801 - TC804.

The output from VFO or crystal oscillator is amplified by buffer amplifier Q802, 2SC372Y, and fed through the band pass filter to the second gate of Q403 and Q404.

POWER SUPPLY

The power supply is designed to operate from either 100/110/117/200/220/234 volts AC or 12 volts DC (negative ground). Inserting the appropriate power plug into the rear panel receptacle makes necessary connections to operate the supply in either AC or DC.

When the AC cord is inserted, AC voltage is applied to pins 1 and 2, and fed to the power transformer through fuse and power switch. The secondary output of the power transformer is rectified by KBL-02 rectifier, and fed to the voltage regulator Q1, 2N3055, to obtain regulated 13.5 volts DC supply.

A part of the 13.5 volt supply is fed to other voltage regulator which consists of Q102, 2SD313E, and Q104, 2SC372Y, to obtain an extremely stable 9 volts DC supply.

For DC operation, DC voltage is applied to pin 3 and 4 of the receptacle. This voltage is supplied to the transceiver through power switch. The regulator circuit by Q102 and Q104 is used for the regulated 9 volt supply.

AUXILIARY CIRCUIT

In addition to the basic circuit described above, a number of auxiliary circuits are adopted to optimize the performance of this transceiver.

1. Noise Blanker

Output from the receiver first IF Q201 is amplified by the noise amplifier Q218 and Q219, 2SK19GR. The signal amplified by Q218 and Q219 is rectified by D201, 1S1555, and biases D202, 1S1555. D202 conducts with the noise pulse and the negative output voltage from the diode is applied to the gate of Q203, 2SK19GR, in order to turn off Q203. Then the noise blanker driver Q204, 2SC372Y, conducts to switch a noise blanker diode D204, 1S1555, which disconnects the input circuit of the filter. The switching level is adjusted by the noise blanker threshold control VR201. At the most effective blanking position, there may be slight distortion on the received signal due to mixing at the switching diode. This effect can be reduced by readjusting the threshold control slightly.

2. AGC (Automatic Gain Control) Circuit

A part of output from receiver IF amplifier Q208 is rectified by voltage doubler D212 and D213, 1S1007. This DC voltage is amplified by AGC amplifier Q209, 2SC828Q, and applied to the RF amplifier Q401, IF amplifier Q207 and Q208 to reduce the gain automatically when a strong signal is received. This AGC voltage is amplified by the S-meter amplifier Q210, 2SC828Q, for S-meter indication.

3. Squelch Circuit

The voltage variation at the collector of S-meter amplifier Q210, 2SC828Q, is fed to the Schmit circuit Q211 and Q212, 2SC372Y, through the squelch threshold control. When incoming signal disappears, the collector voltage of Q210 and Q212 rises in order to conduct squelch control transistor Q213, 2SC372Y. Q213 is so connected in parallel to the output of audio amplifier Q214 that conduction of Q213 shorts the audio signal pass between Q214 and Q215 to the ground. When signal is received, Q213 stops conducting and the audio signal is fed to Q215 from Q214.

4. Clarifier Circuit

A varactor diode D601, 1S2236 is connected to the VFO tank circuit in order to tune the receiver frequency a few kHz either side of the transmitting frequency. In receive mode, the bias voltage for D601 is fed through the clarifier control VR5, and in transmit mode this voltage is fed from the voltage divider R3 and R4.

5. Output Indicator

A part of the RF output power is fed to the RF rectifier D1, 1S188, through capacitor C1 and the rectified DC voltage is used to read relative power output on the meter.

6. ALC (Automatic Level Control) Circuit

The ALC rectifier diode D504, 1S188, is so biased that it conducts for only higher signal than predetermined level. The audio signal detected by D504 is rectified by the voltage doubler D505 and D506, V06B, and then fed to the transmitter IF stage Q205 and Q206 to control the IF gain in order to prevent distortion due to over drive.

VR503 ALC ADJUST.

7. AFP (Automatic Final Protection) Circuit

This circuit is provided to protect the final transistor against over load condition, which may occur if the transmitter is keyed without an antenna or with a high VSWR antenna system.

When the reflected power increases, the diode D503, 1S188, detects the voltage and supplies a control voltage to the gate of controller D402, CW01B, which conducts through AFP threshold control VR502. Thus supply voltage to the transmitter second mixer drops and the mixer gain decreases to protect the following stages.

CW BREAK-IN AND SIDETONE

With the key down, a phase shift oscillator Q901, 2SC372Y, generates 800 Hz sidetone signal and is fed through sidetone level control VR901 to the audio amplifier Q215 for the sidetone monitoring. A part of the 800 Hz from Q901 is amplified by Q902, 2SC372Y, and rectified by D901 and D902, 1S1555.

This negative voltage cuts off Q903, 2SK19Y, in turn a relay control transistor Q904, 2SC372Y, conducts to activate the relay RL1 and the signal is transmitted. With the key up, Q904 stops conducting and the relay recovers into receive condition. The relay hold time can be adjusted by VR902.

CRYSTAL CALCULATION FOR CRYSTAL CONTROLLED OPERATION

The crystal holders accept standard HC-25/U type crystals. All crystal frequencies must fall between 5,000 kHz and 5,500 kHz. A trimmer capacitor is connected in series with each crystal to permit proper frequency adjustment within approximately 1 kHz.

The correct crystal frequency of any desired operating frequency may be determined by the following formula:

$$f_x = f_1 - f_o$$

When f_x is the crystal frequency, f_o is the operating frequency and the constant f_1 is taken from the following table.

BAND (MHz)	LSB	USB	AM/CW
50.0 ~ 50.5	55501.5	55498.5	55499.3
50.5 ~ 51.0	56001.5	55998.5	55999.3
51.0 ~ 51.5	56501.5	56498.5	56499.3
51.5 ~ 52.0	57001.5	56998.5	56999.3
52.0 ~ 52.5	57501.5	57498.5	57499.3
52.5 ~ 53.0	58001.5	57998.5	57999.3
53.0 ~ 53.5	58501.5	58498.5	58499.3
53.5 ~ 54.0	59001.5	58998.5	58999.3

Table 1

For example;

Find the proper crystal for operation at 51.9 MHz USB.

From the table, the constant f_1 is 56998.5 kHz.

Therefore, $f_x = 56998.5 \text{ kHz} - 51900 \text{ kHz} = 5098.5 \text{ kHz}$.

ALIGNMENT

CAUTION =====

NEVER OPERATE THE TRANSCEIVER IN TRANSMIT MODE WITHOUT A MATCHED ANTENNA OR ADEQUATE DUMMY LOAD.

GENERAL

The transceiver has been carefully aligned and tested at the factory and, with normal usage, should not require other than usual attention given to electronic equipment. Service or replacement of a major component may require subsequent realignment, but under no circumstance should realignment be attempted unless the operation of the transceiver is fully understood and the malfunction has been analyzed and definitely traced to misalignment. Service work should only be performed by experienced personnel, using the proper test equipment.

EQUIPMENT REQUIRED

- (1) RF Signal Generator with one volt output at an impedance of 50 ohms and a frequency coverage of 5 MHz to 60 MHz.
- (2) Vacuum Tube Voltmeter (VTVM), Hewlett Packard model 401B, or equivalent with a RF-probe good to 60 MHz.
- (3) Dummy Load, 50 ohms non-reactive load rated at 20 watts, Yaesu model YP-150, or equivalent.
- (4) Frequency Counter, Yaesu model YC-355D, or equivalent.

NOTE : Cores in coil form are fixed by wax. Melt the wax with hot soldering iron to adjust cores.

RECEIVER

1. S-Meter Adjustment

Disconnect the antenna from the antenna terminal. Set the transceiver to receive mode. Set VR202 in the IF AF board to fully clockwise position. Adjust VR204 until the meter shows full scale. Set the VR202 fully counter-clockwise position and adjust VR203 until the meter shows zero reading.

2. Noise Blanker Threshold Level

The operating level of the noise blanker is determined by the threshold control VR201. With the noise blanker OFF position, tune in a signal on any band that registers S9. Note the S-meter changes when the noise blanker is placed in the circuit. When the noise blanker level is adjusted properly by VR201, the meter should indicate a decrease of one of half S-unit. Excessive setting of the threshold control may result in the cross-modulation.

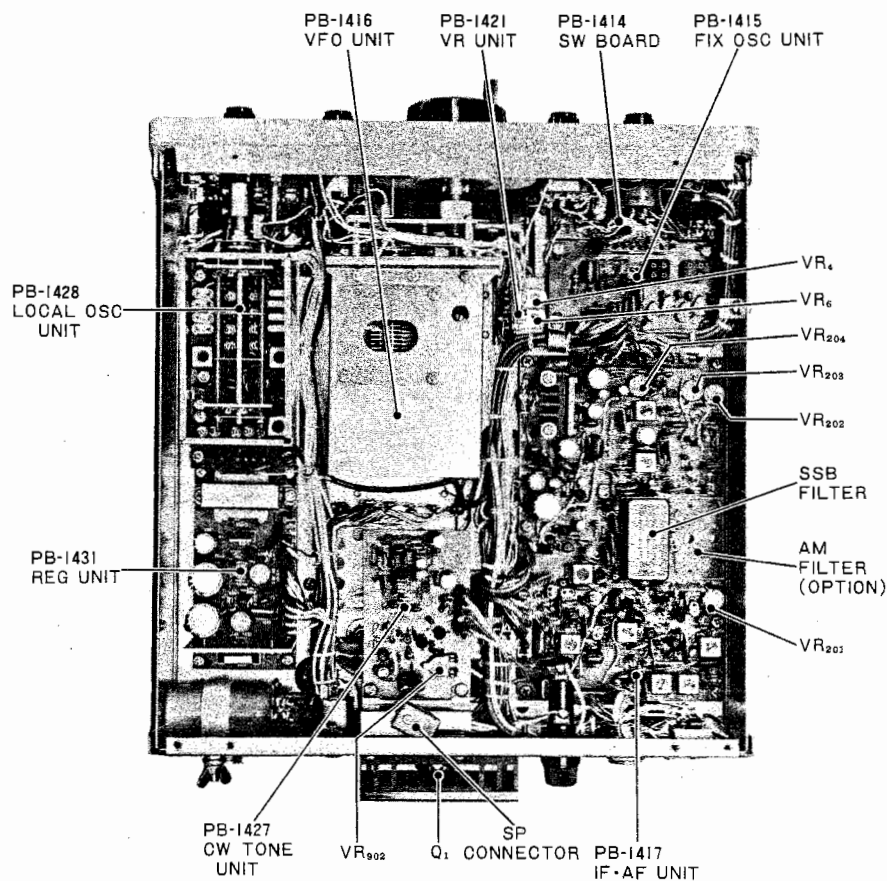

BOTTOM VIEW

3. Squelch Threshold Level

Set the mode switch to SSB mode and disconnect the antenna from the antenna terminal. Set the SQUELCH control on the front panel to 3 position. Adjust VR4 (THRESHOLD) to the point where the noise disappears.

4. Clarifier

Set the clarifier control to OFF position. Tune in a signal and zero beat in the USB mode. Set the clarifier control to zero, 12 o'clock position. Adjust VR6 (0-SET) for zero beat.

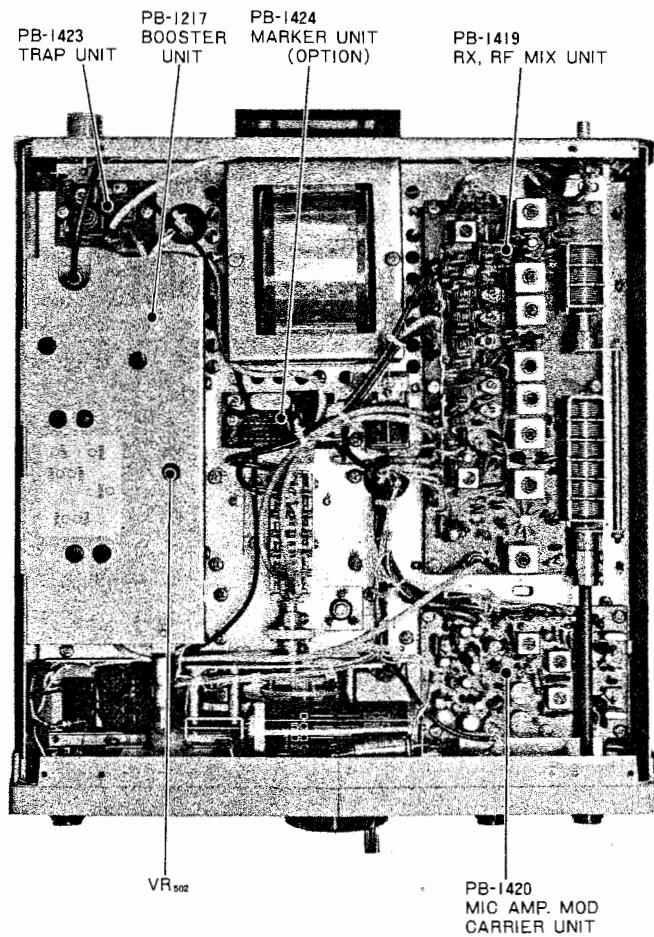

TOP VIEW

TRANSMITTER

CAUTION

=====

CONTINUOUS FULL OUTPUT FOR MORE THAN 10 SECONDS
MAY RESULT IN DESTRUCTION OF THE FINAL POWER TRANSISTOR.

Connect a 50 ohm dummy load to the antenna terminal. Set the BAND switch to 52 MHz. Adjust L411 - L415, TC406 and TC501 - TC504 for maximum output.

1. AFP (Automatic Final Protection) Circuit

THE FOLLOWING ADJUSTMENT SHOULD BE COMPLETED IN
A SHORT TIME TO PROTECT THE FINAL TRANSISTOR.

Tune up the transceiver for full output into the dummy load in the CW mode. Set VR502 in the final amplifier unit fully counter-clockwise and disconnect the dummy load from the antenna jack. Carefully observing the power output indication (meter switch at P.O. position), advance the VR502 clockwise until the meter indication abruptly drops to zero. Set the transceiver to receive mode and connect the dummy load to the antenna jack. Then transmit again and check the transmitter works normally.

2. CW Break-in Hold Time

The relay hold time of the CW break-in operation can be adjusted by VR902 located on the CW TONE UNIT for a comfortable operation. Clockwise rotation makes longer hold time.

3. CW Sidetone Level

The sidetone level is adjusted by VR8 for comfortable operating level.

OPTIONAL UNIT

- * 100 KHz Marker Oscillator
- * 6 KHz Crystal Filter for AM (XF90B)

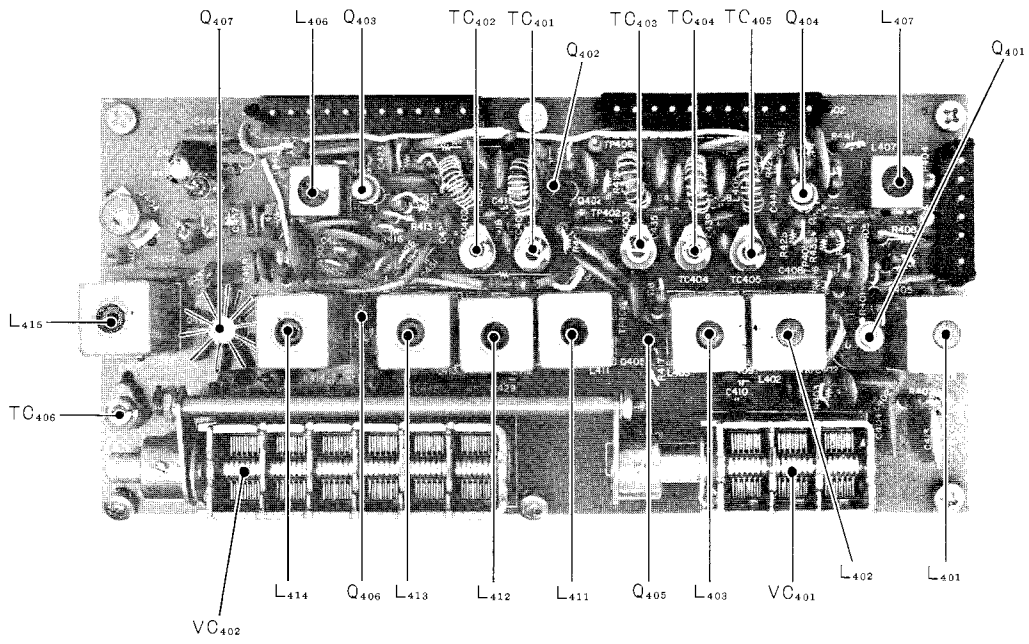

PB-1419 RF·MIX UNIT

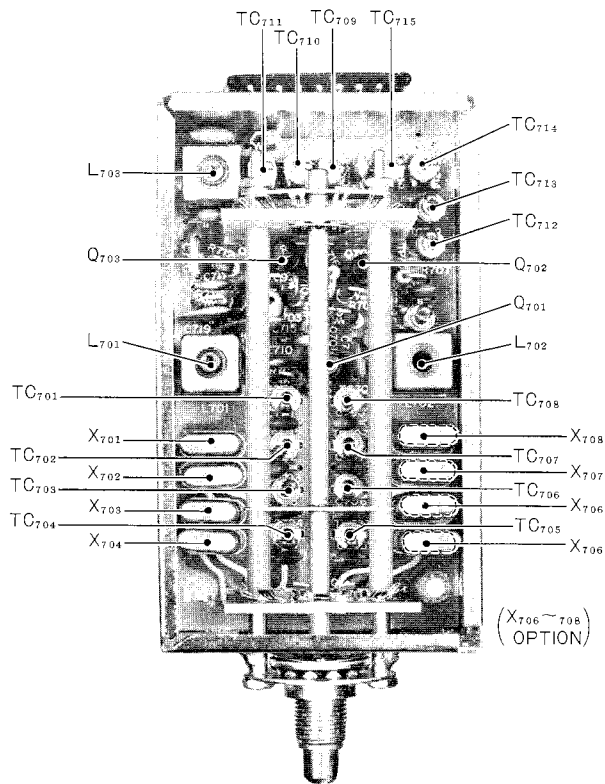

PB-1428 1st LOCAL OSC UNIT

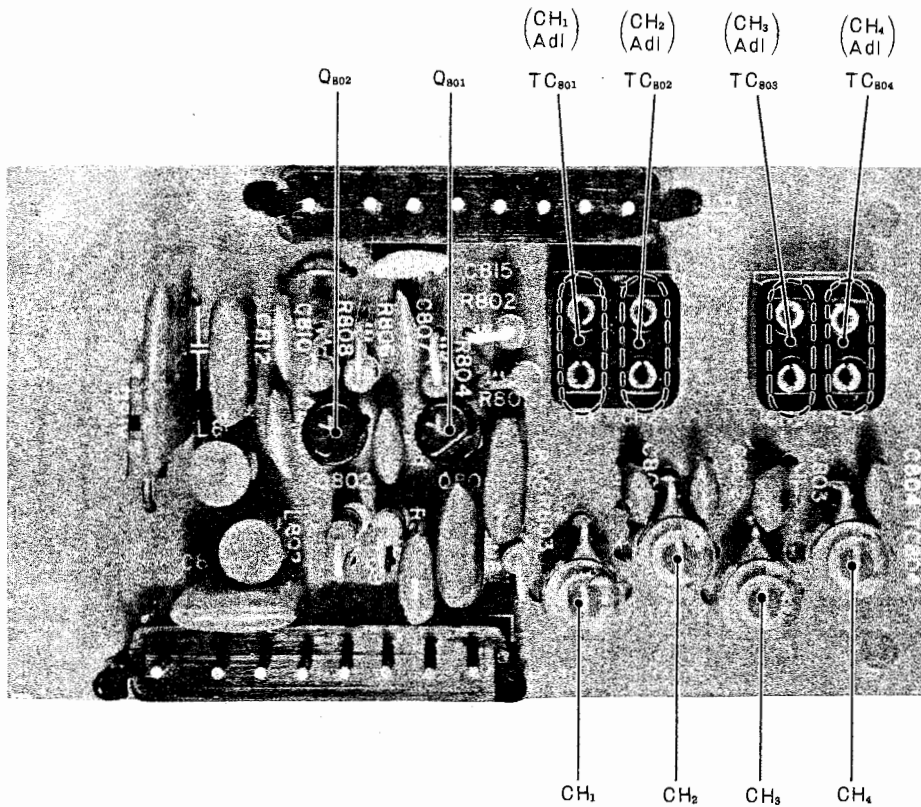

PB-1414 FIX CHANNEL OSC UNIT

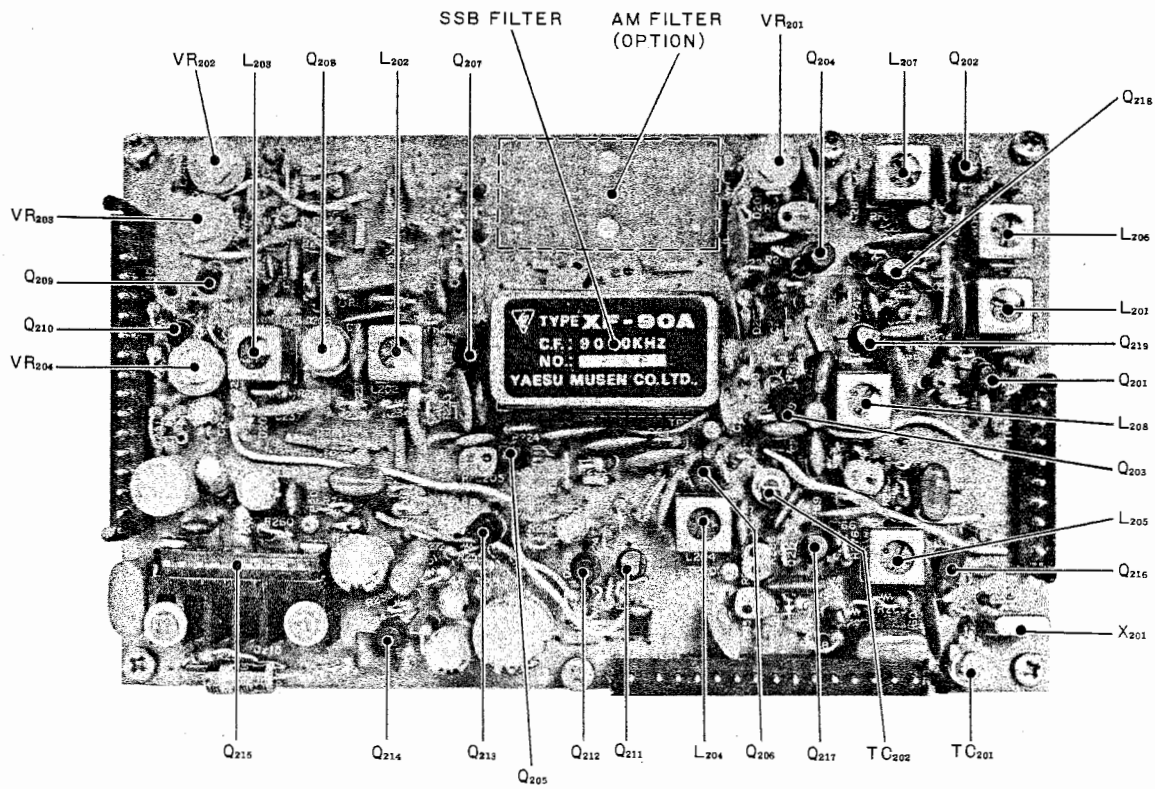

PB-1417 AF-IF UNIT

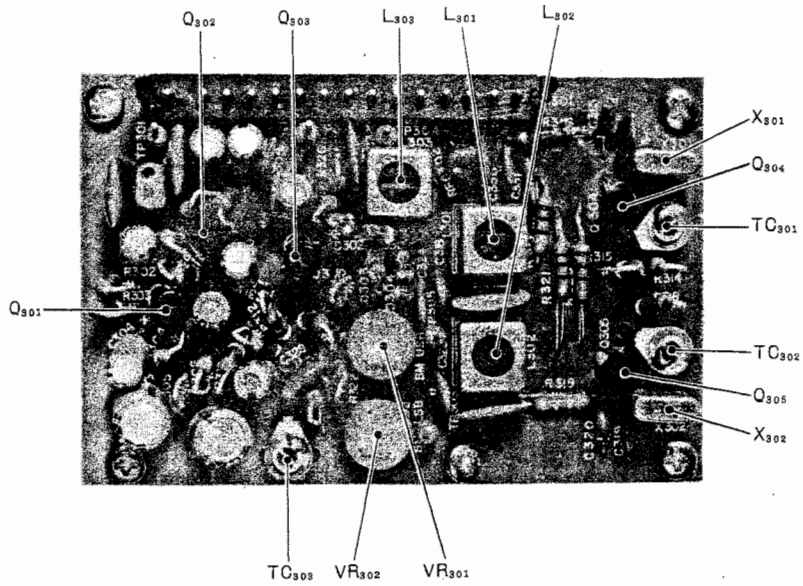

PB-1420 MIC AMP, MOD, DARRIER UNIT

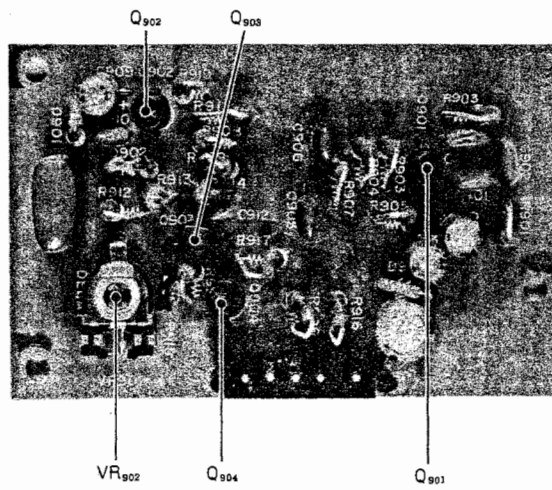

PB-1427 CW TONE UNIT

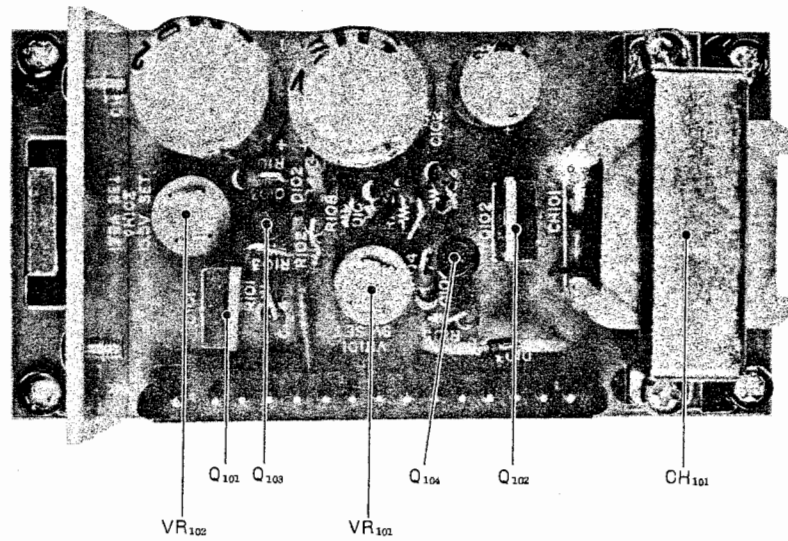

PB-1431 REG UNIT

PARTS LIST

MAIN CHASSIS			1	J50-239
PB-PRINTED CIRCUIT BOARD			2	SG-7615
1360(A~Z) LAMP BOARD			3	SB-0822
1421(A~Z) VR BOARD			4	QMS-AB4M
Q-TRANSISTOR			5	FM-146S
1	2N3055		6	SG-7814
			7	SG-8050
			8	CN-1463
D D-DIODE			F-FUSE	
1	DS-130-ND		1	2A
2	V06B			
R-REISTOR			FH-FUSE HOLDER	
CARBON FILM			1	SN-1001
8	$\frac{1}{4}$ W	150K Ω		
CARBON COMPOSITION			PL-PILOT LAMP	
6	$\frac{1}{2}$ W	10 Ω	1,2	15V 0.15A
7	$\frac{1}{2}$ W	100 Ω	3,4	6V 65mA
2	$\frac{1}{2}$ W	150 Ω		
1	$\frac{1}{2}$ W	10K Ω		
3,5	$\frac{1}{2}$ W	33K Ω	1,2	BH641-01361B
4	$\frac{1}{2}$ W	47K Ω		
VR-POTENTIOMETER			RF MIX UNIT	
1,7	VM20A-5KB	5K Ω B	PB-PRINTED CIRCUIT BOARD	
2	VM13A-5M3121-5KA	5K Ω A with PULL SW	1419(A~Z) RF, MIX BOARD	
3	VM11A-5M1112-50KB	50K Ω B with SW		
5	VM11A-5M1222	50KB 50K Ω B with SW	Q-FET & TRANSISTOR	
7	VM20A-5KB	5K Ω B	401,403,404	FET 3SK40M
8	EVH-BOAR15A14	10K Ω B	402,405	FET 2SK19Y
4,6	TR11R		406	2SC784R
			407	2SC1216
C-CAPACITOR			D-DIODE	
DIPPED MICA			401	Si V06B
1	50WV	3PF	402	Thyristor CW01B
CERAMIC DISC				
2~5,10,11	50WV	0.0047 μ F		
7,8	1.4KWV	0.0047 μ F	R-RESISTOR	
MYLAR			CARBON FILM	
6	50WV	0.1 μ F	427,429,441	$\frac{1}{4}$ W 56 Ω
ELECTROLYTIC			408,412,416,420,439	$\frac{1}{4}$ W 100 Ω
12	25WV	470 μ F	419,424,442	$\frac{1}{4}$ W 220 Ω
9	25WV	3300 μ F	407	$\frac{1}{4}$ W 330 Ω
VC-VARIABLE CAPACITOR			414	$\frac{1}{4}$ W 470 Ω
			428	$\frac{1}{4}$ W 560 Ω
1	C512C		410,417,421,426	$\frac{1}{4}$ W 1K Ω
2	C365A		406	$\frac{1}{4}$ W 1.5K Ω
			415	$\frac{1}{4}$ W 2.2K Ω
RFC-RF CHOKE			423,425,436	$\frac{1}{4}$ W 10K Ω
1	2mH		404,435	$\frac{1}{4}$ W 22K Ω
			418,422,438	$\frac{1}{4}$ W 33K Ω
PT-TRANSFORMER			401,402,403,405,409,411	$\frac{1}{4}$ W 100K Ω
1	52-26		437	$\frac{1}{4}$ W 150K Ω
			413	$\frac{1}{4}$ W 220K Ω
M-METER			CARBON COMPOSITION	
1	FT620B S/PO		432	$\frac{1}{2}$ W 2.2 Ω
			434	$\frac{1}{2}$ W 5.6 Ω
SP-SPEAKER			431	$\frac{1}{2}$ W 10 Ω
1	SA-70	4 Ω 3W	430	$\frac{1}{2}$ W 22 Ω
RL-RELAY			C-CAPACITOR	
1	AE-3171		DIPPED MICA	
			429,437,438,445	50WV 1PF
RLS-RELAY SOCKET			447	50WV 10PF
1	AE-3860		418,421,439	50WV 20PF
			402,407,410,428,441	50WV 30PF
SW-SWITCH			438,448,455,462,463	
1	5PFS-12U-533-1LJ		435	50WV 39PF
			403	50WV 51PF
J-RECEPTACLE			417,420,436,440,442	50WV 56PF

412, 422, 434	50WV	100PF	287	1/4 W	330Ω
460	50WV	200PF	203, 291, 292	1/4 W	470Ω
CERAMIC			217, 218, 220, 221	1/4 W	560Ω
409, 419	50WV	0.5PF	210, 224, 227, 233, 236,	1/4 W	1KΩ
CERAMIC DISC			239, 243, 257, 266, 270,		
456~459	50WV	0.001μF	272, 273, 288		
416, 423, 433, 446, 468,	50WV	0.01μF	209	1/4 W	1.5KΩ
404~406, 408, 413, 415	50WV	0.047μF	214, 235, 246, 249,	1/4 W	2.2KΩ
424, 426, 431, 443, 444	50WV		255, 293		
450~453, 464, 466, 469			212, 213, 219, 222, 229,	1/4 W	3.3KΩ
ELECTROLYTIC			230, 240, 242, 252, 256,		
467	16WV	4.7μF	268, 271, 274, 275, 285		
VC-VARIABLE CAPACITOR			202, 264, 286, 289	1/4 W	4.7KΩ
			232, 253	1/4 W	6.8KΩ
401	C332A	18PF×3	238, 247, 248, 277, 278	1/4 W	10KΩ
402	C365A	18PF×6	259	1/4 W	18KΩ
TC-TRIMMER CAPACITOR			251, 258, 280	1/4 W	22KΩ
			201, 205, 231, 282	1/4 W	27KΩ
401~406	ECV-1ZW	40P32	262	1/4 W	33KΩ
L-INDUCTOR			260, 267	1/4 W	39KΩ
			245	1/4 W	47KΩ
401	Antenna	#LR100	208, 211, 223, 226, 254	1/4 W	100KΩ
402, 403	RF	#LR101, 102	263, 290		
404, 405	MIX (Recieve)	#LR103, #104	284	1/4 W	470KΩ
406	IF (")	#4170	244	1/4 W	1MΩ
407	IF (Transmit)	#4170			
408~410	MIX (")	#LR105	VR-POTENTIOMETER		
411~415	6m Amp(")	#LR106, 107, 108	202, 203	SR19R	470ΩB
			204	SR19R	2.2ΩB
RFC-RF CHOKE			201	SR19R	10KΩB
401	CHOKE COIL	#LR115			
402	CHOKE COIL	#LR116	C-CAPACITOR		
P&J-CONNECTOR			DIPPED MICA		
			203	50WV	3PF
401	PIN	128-6-10-181P(S)	257	50WV	15PF
402, 403	PIN	128-11-10-181P(S)	238, 258, 261	50WV	20PF
404		SQ-4052 (PLUG)	206, 270, 274	50WV	30PF
		SQ-3056 (JACK)	220	50WV	47PF
			267	50WV	56PF
			209, 239, 268, 282	50WV	100PF
IF-AF UNIT			233	50WV	470PF
PB-PRINTED CIRCUIT BOARD			262	50WV	620PF
1417(A~Z) IF-AF BOARD			CERAMIC		
			212	50WV	0.5PF
Q-IC FET & TRANSISTOR			CERAMIC DISC		
208	IC	TA-7045M	242	50WV	0.001μF
215	IC	AN-214	201, 213, 218, 221, 225,	50WV	0.01μF
203, 205, 206, 218	FET	2SK19GR	240, 241, 281		
204, 211~214, 217, 219		2SC372Y	202, 205, 208, 215~217,	50WV	0.047μF
216		2SC710D	219, 222~224, 226, 228~230,		
201, 202, 207		2SC784R	232, 234, 235, 237, 260, 263,		
209, 210		2SC-828R	265, 266, 273, 279		
			MYLAR		
D-DIODE			211, 271, 283	50WV	0.01μF
205~209, 211, 214	Ge	1S188FM	210	50WV	0.047μF
204, 212, 213	Ge	1S1007	247, 280, 284	50WV	0.033μF
201, 202, 210	Si	1S1555	249, 250, 275	50WV	0.1μF
215	Si	V06B	255, 264	50WV	0.22μF
203	Zener	WZ110	TANTALUM		
			243	16WV	4.7μF
X-CRYSTAL			ELECTROYTIC		
201	HC-18/u	9000.7KHz	246	16WV	1μF
			276	16WV	4.7μF
XF-CRYSTAL FILTER			244, 245, 254, 269	16WV	10μF
201	AM	9000KHz(OPTION)	248, 253	16WV	47μF
202	SSB	9000KHz	251	16WV	100μF
			256	16WV	220μF
R-RESISTOR			252	16WV	470μF
CARBON FILM			TC-TRIMMER CAPACITOR		
250	1/4 W	22Ω			
261	1/4 W	82Ω	201	ECV-1ZW	20P32
204, 207, 225, 228	1/4 W	100Ω	202	ECV-1ZW	50P32
234, 237, 241, 265, 276, 283					
279, 281	1/4 W	150Ω	L-INDUCTOR		
206, 216, 269	1/4 W	220Ω	201~204, 206~208	IFT	9MHz #4170

205	OSC.	9MHz #4170	P&J-PIN CONNECTOR	
			301	128-15-10-181 P(S)
RFC-RF CHOKE				
207		10 μ H	LOCAL OSC UNIT	
202~206,208		250 μ H	PB-PRINTED CIRCUIT BOARD	
201,209		1mH	1428	LOCAL OSC BOARD
P&J-PIN CONNECTOR				
201	128-8-10-181	P(S)	Q-TRANSISTOR	
202,203	128-15-10-181	P(S)	701	2SC373
			702,703	2SC784R
MIC AMP UNIT			X-CRYSTAL	
PB-PRINTED CIRCUIT BOARD			701	HC-25/U 64.5MHz
1420(A~Z)	MIC AMP BOARD		702	HC-25/U 65.0MHz
			703	HC-25/U 65.5MHz
			704	HC-25/U 66.0MHz
Q- Q-TRANSISTOR			705	HC-25/U 66.5MHz (OPTION)
301~303		2SC372Y	706	HC-25/U 67.0MHz (")
304,305		2SC710D	707	HC-25/U 67.5MHz (")
			708	HC-25/U 68.0MHz (")
D-DIODE			XS-CRYSTAL SOCKET	
301~304		Ge 1S1007	701~708	S2-101P
305		Si 1S1555		
X-CRYSTAL			R-RESISTOR	
301	HC-18/U	9001.5kHz	CARBON FILM	
302	HC-18/U	8998.5kHz	706,712	$\frac{1}{4}$ W 100 Ω
R-RESISTOR			713	$\frac{1}{4}$ W 220 Ω
CARBON FILM			701,711	$\frac{1}{4}$ W 470 Ω
311,317,321	$\frac{1}{4}$ W	100 Ω	705	$\frac{1}{4}$ W 680 Ω
322~325	$\frac{1}{4}$ W	220 Ω	708	$\frac{1}{4}$ W 1K Ω
310,313	$\frac{1}{4}$ W	470 Ω	709	$\frac{1}{4}$ W 3.3K Ω
316,320	$\frac{1}{4}$ W	560 Ω	702,710	$\frac{1}{4}$ W 10K Ω
303,305,309	$\frac{1}{4}$ W	1K Ω	707	$\frac{1}{4}$ W 18K Ω
306,326	$\frac{1}{4}$ W	3.3K Ω	703,704	$\frac{1}{4}$ W 22K Ω
302	$\frac{1}{4}$ W	3.9K Ω	C-CAPACITOR	
304,308,314,318	$\frac{1}{4}$ W	4.7K Ω	DIPPED MICA	
307	$\frac{1}{4}$ W	22K Ω	701~709,714	50WV 10PF
301,315,319	$\frac{1}{4}$ W	33K Ω	721	50WV 15PF
312	$\frac{1}{4}$ W	100K Ω	712,713	50WV 20PF
VR-POTENTIOMETER			722	50WV 51PF
301,302	SR19R	220 Ω B	CERAMIC DISC	
C-CAPACITOR			716	50WV 0.001 μ F
DIPPED MICA			710,711,715,717,720	50WV 0.01 μ F
332	50WV	10PF	718,719	50WV 0.047 μ F
314,319	50WV	15PF	TC-TRIMMER CAPACITOR	
315,320	50WV	20PF	701~716	ECV-1ZW 20P51
328	50WV	51PF	L-INDUCTOR	
301,302	50WV	240PF	701	LOCAL OSC #2201
CERAMIC DISC			702	LOCAL OSC #4599
318,323	50WV	0.001 μ F	703	OSC. OUT #4102
324,329~332	50WV	0.01 μ F	RFC-RF CHOKE	
317,322,325	50WV	0.047 μ F	701	10 μ H
MYLAR				
307	50WV	0.0033 μ F	S-BAND SWITCH	
ELECTROLYTIC			701	2-2-8
303,305,306,311,312	16WV	1 μ F	P&J-PIN CONNECTOR	
304,309,313	16WV	10 μ F	701	128-7-10-181 P(S)
308,310	16WV	47 μ F		
TC-TRIMMER CAPACITOR				
301,302	ECV-1ZW	20P32	VFO UNIT	
303	ECV-1ZW	50P32	PB-PRINTED CIRCUIT BOARD	
L-INDUCTOR			1416(A~Z) VFO BOARD	
301,302	OSC.	9MHz #4170	Q-FET & TRANSISTOR	
303	BM.	9MHz #4170	603	FET 2SK19GY
RFC-RF CHOKE			601,602	2SC372Y
301		250 μ H	D-DIODE	
302		1mH		

601	Varactor	1S2236	CERAMIC DISC	807,810,811,815	50WV	0.01 μ F
R-RESISTOR						
CARBON FILM			TC-TRIMMER CAPACITOR			
609,611,614	$\frac{1}{4}$ W	100 Ω	801~804	ECV-1ZW		40P32
613	$\frac{1}{4}$ W	220 Ω				
610	$\frac{1}{4}$ W	1K Ω	L-INDUCTOR			
615	$\frac{1}{4}$ W	1.5K Ω	801,802			2.2 μ H
602,606	$\frac{1}{4}$ W	2.2K Ω				
603	$\frac{1}{4}$ W	3.3K Ω	S-SWITCH			
601	$\frac{1}{4}$ W	10K Ω	801	5FS-10U-388-1LK		
604,608	$\frac{1}{4}$ W	18K Ω				
607	$\frac{1}{4}$ W	22K Ω	P&J-PIN CONNECTOR			
605	$\frac{1}{4}$ W	33K Ω	801,802	128-8-10-181	P(S)	
612	$\frac{1}{4}$ W	100K Ω				
C-CAPACITOR			BOOSTER UNIT			
DIPPED MICA			PB-PRINTED CIRCUIT BOARD			
610	50WV	6PF	1217(A~Z) BOOSTER BOARD			
614	50WV	15PF				
603	50WV	30PF	Q-TRANSISTOR			
606	50WV	68PF	501	2SC1306		
616	50WV	100PF	502	2SC1307		
604	50WV	240PF				
607	50WV	470PF	D-DIODE			
CERAMIC DISC			503,504	Ge	1S188FM	
605,608,609,611,	50WV	0.01 μ F	501,502	Varistor	1S1209	
612,615,617			505,506	Si	V06B	
CERAMIC T.C.						
613	500WV	5PF UJ	R-RESISTOR			
601	500WV	10PF UJ	CARBON COMPOSITION			
602	500WV	20PF NPO	507	$\frac{1}{2}$ W		56 Ω
TC-TRIMMER CAPACITOR			503,508	$\frac{1}{2}$ W		470 Ω
601	KC30PM		512	$\frac{1}{2}$ W		100K Ω
L-INDUCTOR			513	$\frac{1}{2}$ W		1M Ω
OSC. COIL			VR-POTENTIOMETER			
601	#LR112		501	SR19R		470 Ω B
602	RFC	250 μ H	502,503	SR19R		10K Ω B
FIX UNIT			C-CAPACITOR			
PB-PRINTED CIRCUIT BOARD			DIPPED MICA			
1414(A~Z)	CHANNEL SWITCH BOARD		522	50WV		2PF
1415(A~Z)	FIX OSC BOARD		523	50WV		5PF
			518,521	50WV		24PF
			508	50WV		39PF
Q-TRANSISTOR			519,520	50WV		62PF
801,802	2SC372Y		514,515	50WV		82PF
X-CRYSTAL (OPTION)			CERAMIC DISC			
801~804	HC-25/U	5000kHz~5500kHz	503,504,506,507,	50WV		0.001 μ F
			510~513			
			501,516,525,526,528	50WV		0.01 μ F
XS-CRYSTAL SOCKET			517,524,530	50WV		0.047 μ F
801~804	S14-2P		MYLAR			
			527	50WV		0.1 μ F
R-RESISTOR			ELECTROLYTIC			
CARBON FILM			502,505,529	16WV		22 μ F
808	$\frac{1}{4}$ W	100 Ω	509	16WV		100 μ F
804,809	$\frac{1}{4}$ W	220 Ω				
803	$\frac{1}{4}$ W	1K Ω	TC-TRIMMER CAPACITOR			
801	$\frac{1}{4}$ W	5.6K Ω	501,502	ECV-1ZW		50P32
805	$\frac{1}{4}$ W	6.8K Ω	503,504	CV08S600		
806	$\frac{1}{4}$ W	15K Ω				
802	$\frac{1}{4}$ W	22K Ω	L-INDUCTOR			
CARBON COMPOSITION			501	DRIVER COIL		#LR109
810	$\frac{1}{2}$ W	82 Ω	502	FINAL COIL		#LR110
			503~505	LOW PASS COIL		#LR111
C-CAPACITOR			RFC-RF CHOKE			
DIPPED MICA			501,502,504			#LR115
801~804	50WV	10PF	503,505			#LR117
808	50WV	30PF	506,507			250 μ H
809	50WV	50PF				
805,806	50WV	200PF	RL-RELAY			
812,813	50WV	400PF	501	AE1323		
814	50WV	800PF				

P&J-CONNECTOR			TC-TRIMMER CAPACITOR		
501	PIN 128-11-10-181	P(S)	1001	ECV-1ZW	50P32
503	PIN 128-3-10-181	P(S)			
502	SQ4052 (PLUG)		L-INDUCTOR		
	SQ3056 (JACK)		1002	9MHz TRAP COIL	#LR113
			1001	14MHz TRAP COIL	#LR114
CW TONE UNIT			RFC-RF CHOKE		
PB-PRINTED CIRCUIT BOARD			1001		22 μ H
1427(A~Z) SIDE TONE BOARD					
Q-FET & TRANSISTOR			REG UNIT		
903	FET	2SK19Y	PB-PRINTED CIRCUIT BOARD		
901,902		2SC372Y	1431(A~Z) REG BOARD		
904		2SC735Y			
D-DIODE			Q-TRANSISTOR		
901,902	Si	1S1555	101,102		2SD313E
903	Zener	WZ 090	103,104		2SC372Y
R-RESISTOR			D-DIODE		
CARBON FILM			101	Silicon Bridge	KBL-02
905	$\frac{1}{4}$ W	220 Ω	104	Zener	WZ-061
916	$\frac{1}{4}$ W	330 Ω	102	Zener	WZ-090
915	$\frac{1}{4}$ W	680 Ω	103	Zener	WZ-110
906,910	$\frac{1}{4}$ W	1K Ω	R-RESISTOR		
907	$\frac{1}{4}$ W	2.2K Ω	CARBON FILM		
909,911	$\frac{1}{4}$ W	3.3K Ω	105	$\frac{1}{4}$ W	330 Ω
901~903	$\frac{1}{4}$ W	4.7K Ω	104	$\frac{1}{4}$ W	390 Ω
917	$\frac{1}{4}$ W	15K Ω	102	$\frac{1}{4}$ W	470 Ω
908	$\frac{1}{4}$ W	27K Ω	106	$\frac{1}{4}$ W	560 Ω
904	$\frac{1}{4}$ W	33K Ω	101,103,109	$\frac{1}{4}$ W	1K Ω
912	$\frac{1}{4}$ W	470K Ω	107,108	$\frac{1}{4}$ W	3.3K Ω
CARBON COMPOSITION			VR-POTENTIOMETER		
913	$\frac{1}{2}$ W	3.3M Ω	101,102	SR19R	1K Ω B
914	$\frac{1}{2}$ W	5.6M Ω			
THERMISTOR			C-CAPACITOR		
918	SDT-250		CERAMIC DISC		
VR-POTENTIOMETER			104	50WV	0.047 μ F
902	EVL-S3AA00B26	2M Ω B	ELECTROLYTIC		
C-CAPACITOR			103	16WV	220 μ F
MYLAR			101,102	25WV	1000 μ F
912	50WV	0.001 μ F	CH-CHOKE COIL		
905,906,910	50WV	0.01 μ F	101	2.5A	2.4mH
901-903	50WV	0.02 μ F	P&J-PIN CONNECTOR		
911	50WV	0.2 μ F	101	128-15-10-181	P(S)
ELECTROLYTIC					
907	25WV	2.2 μ F			
909,913	16WV	10 μ F			
908	16WV	33 μ F	MARKER UNIT (OPTION)		
P&J-PIN CONNECTOR			PB-PRINTED CIRCUIT BOARD		
901	128-5-10-181	P(S)	1424	MARKER BOARD	
TRAP UNIT			Q-IC & TRANSISTOR		
PB-PRINTED CIRCUIT BOARD			1203	IC	SN7490N
1423(A~Z) TRAP BOARD			1201,1202		2SC372Y
D-DIODE			D-DIODE		
1001	Gi	1S188FM	1201	Zener	1S330
R-RESISTOR			X-CRYSTAL		
1001	CARBON FILM $\frac{1}{4}$ W	1.5K Ω	1201	HC-6/U	1MHz
C-CAPACITOR			R-RESISTOR		
DIPPED MICA			CARBON FILM		
1004	50WV	150PF	1205	$\frac{1}{4}$	220 Ω
1003	50WV	240PF	1203	$\frac{1}{4}$	1K Ω
1001,1002	50WV	680PF	1202	$\frac{1}{4}$	10K Ω
CERAMIC DISC			1201	$\frac{1}{4}$	22K Ω
1005	50WV	0.047 μ F	1204	$\frac{1}{4}$	470K Ω
C-CAPACITOR			C-CAPACITOR		
DIPPED MICA			DIPPED MICA		

1205	50WV	5PF	
1206	50WV	39PF	
1201,1202	50WV	1500PF	
	CERAMIC DISC		
1203,1204	50WV	0.01 μ F	
	TC-TRIMMER CAPACITOR		
1201	ECV-1ZW	50P32	
	P&J-PIN CONNECTOR		
1201	128-3-10-181 P(S)		

FT-620B 6-METER TRANSCEIVER

INSTALLATION OF MARKER UNIT

- (1) Locate space for the marker unit on the chassis. Refer to the top view on Page 25 of the instruction manual.
- (2) Install the unit as illustrated in Fig. 2.
- (3) The marker frequency has been calibrated prior to shipment at the factory. The frequency can be recalibrated, if necessary, by adjusting TC1201.

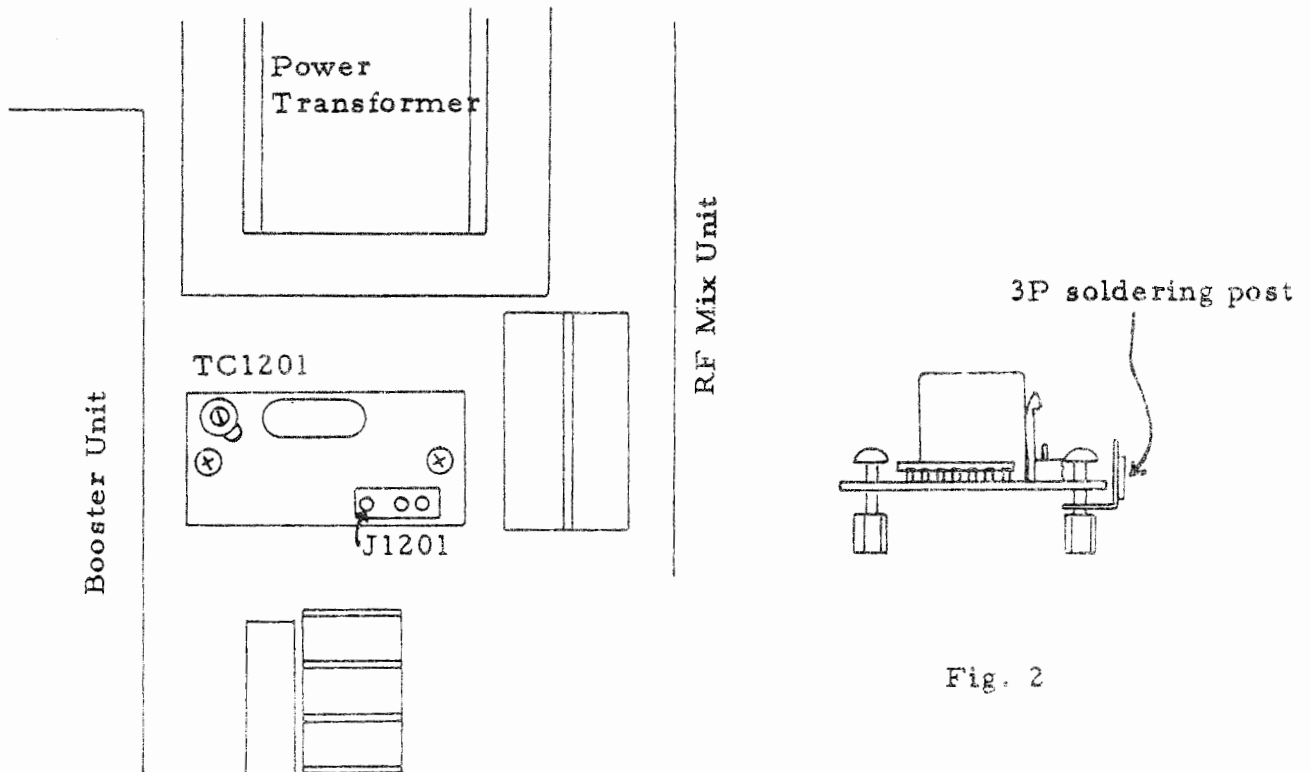
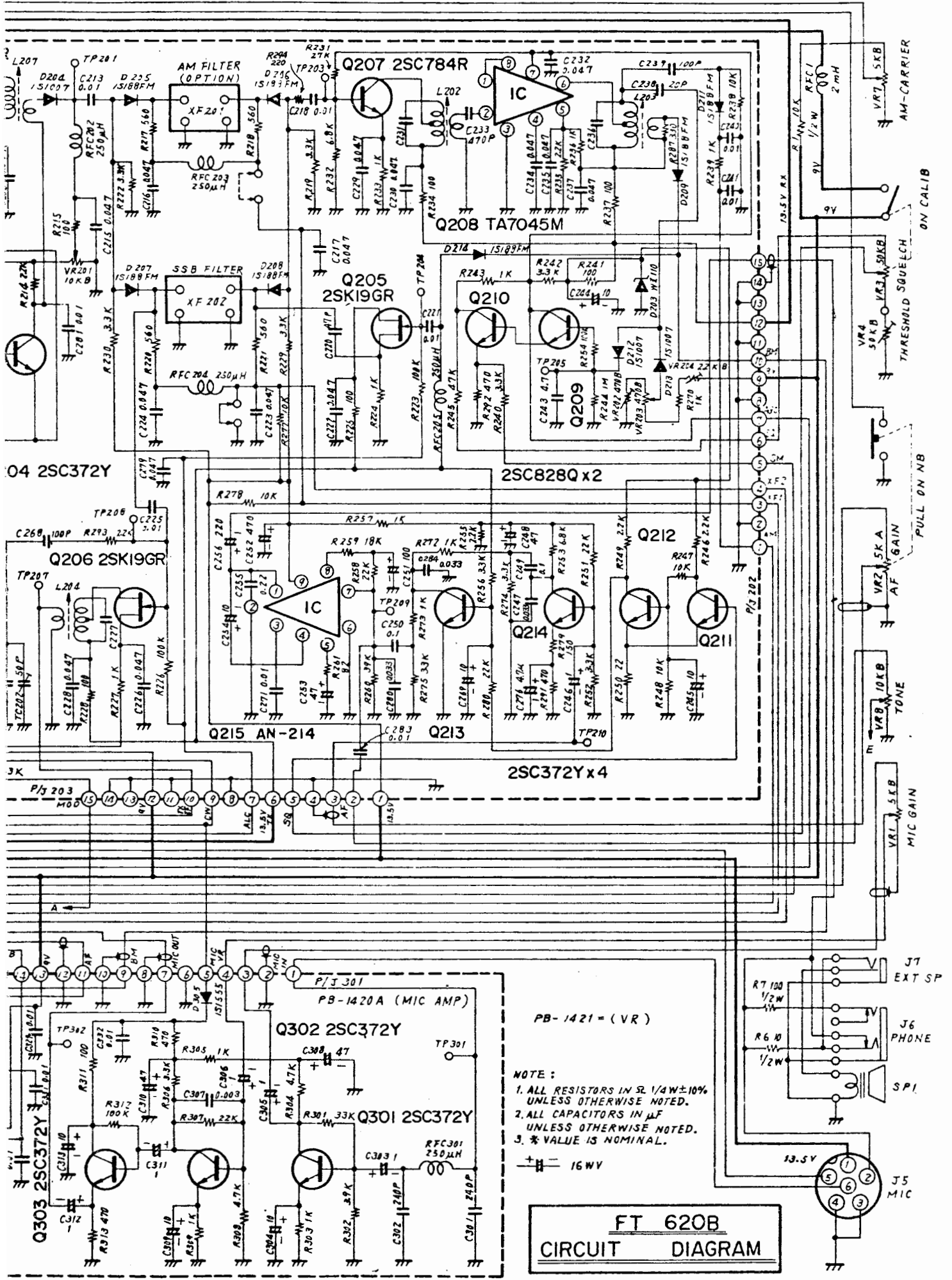

Fig. 1.

Fig. 2



NOTE:

1. ALL RESISTORS IN Ω 1/4% \pm 10% UNLESS OTHERWISE NOTED.
2. ALL CAPACITORS IN μ F UNLESS OTHERWISE NOTED.
3. * VALUE IS NOMINAL.

FT 620B
CIRCUIT DIAGRAM

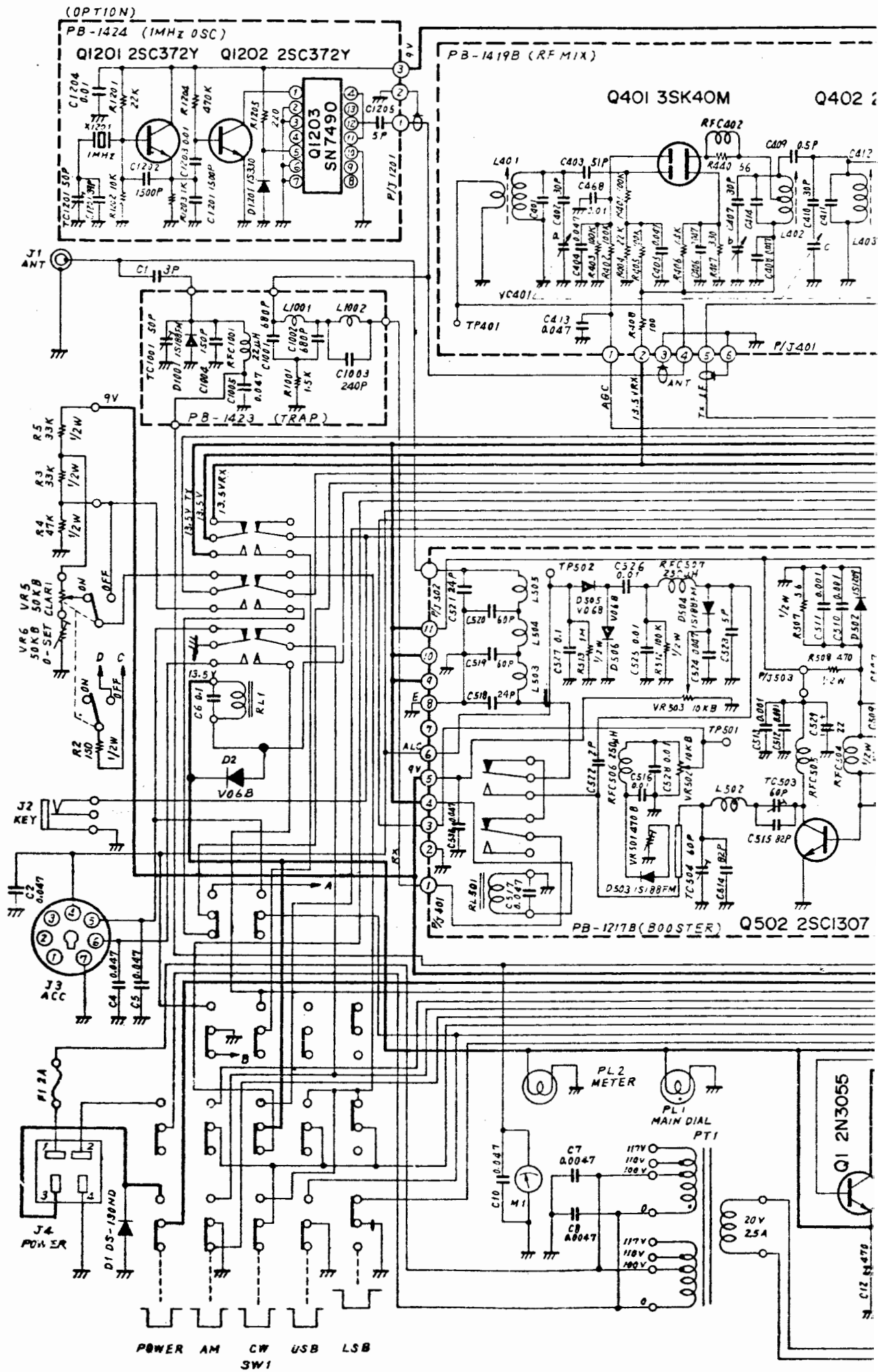



NAI LATCHES FOR FT-620B COVER.

NAI LATCH H322-2-1 Yaesu # S3000001

NAI LATCH H322-2-3-1 Yaesu# S3000005

One of these is the pin and the other is the circular insert.
Yaesu parts 714-827-7600

Replacement cover latch for early Yaesu transceivers FT-221, FT-225, FT-625, FT-620B

Fox Tango International <http://www.foxtango.org>
Carol L. Maher W4CLM

REDUCING TVI CAUSED BY FT-101 RX RADIATION

If you happen to be located in an area where reception of TV Channel 4 is marginal and weak, you may notice a series of fixed diagonal lines on your screen when the FT-101 is operating on 10 meters or receiving 11. The interference is not affected by changing to transmit or modulation. It apparently is caused by radiation from the crystal oscillator stage since pulling the crystal will stop the radiation. Fortunately the problem is worse on 11 meters than on 10; the following suggestion from Yaesu should reduce the radiation. [A better and higher TV antenna and the use of shielded downlead: RG-59/U, will also help. N4ML.]

- * Remove the bottom cover and locate RL-2 (the Antenna relay) and run one white wire between J-16 (the RCV Ant jack) and RL-2 as shown in Fig 2. To the same point, add one end of a 0.4 microhenry choke and one end of a 100pF capacitor and solder into place.
- * Now dress the free end of the capacitor to the chassis ground tab adjacent to the relay socket. Connect one end of a second 100pF capacitor from the rear lug of the RF [Lamp] Fuse holder, and run its free end to the same ground tab and solder both leads to the tab.
- * Dress the free end of the RF Choke to the rear lug of the RF Fuse holder and solder

Diagrams are provided for your assistance. ↘

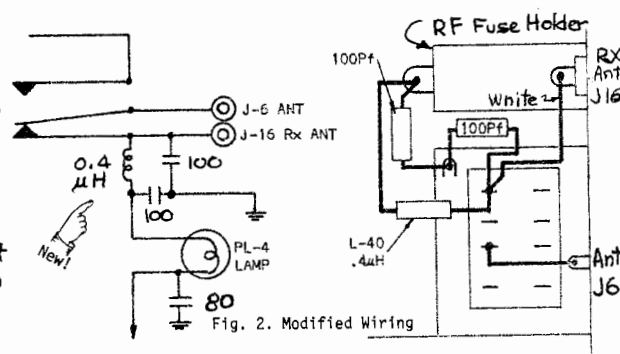
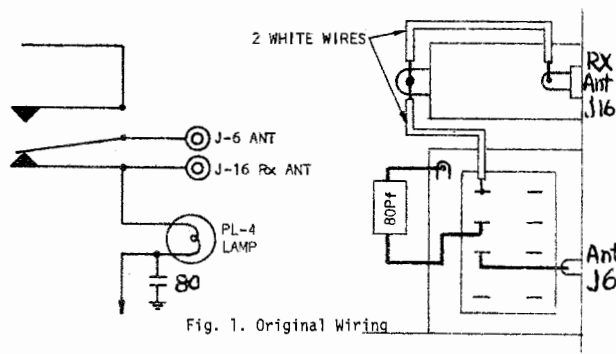

"SMIRK" RECOMMENDS 3N201 FOR FT-620B

Edition #17 of the Six Meter International Radio Klub contains the following for the '620:

For better gain and signal/noise ratio, replace the 3SK40M in the front end with a 3N201B dual-gate MOSFET. It is the only one in a socket and is designated as Q401....For more gain and less internal noise replace the Q403 in the RX Mixer stage with a 3N201 or a 3N211...Order Item 6A2 from Fox-Tango...\$3 airmail postpaid.

Well, if it improves 6-meter reception, it should do the same for lower-frequency signals. There have been several reports indicating that the 3N201 substitution helps in other rigs than Yaesu---pass the word. No "magic"! Just a better unit, at a fair price.

FLEETING THOUGHTS

What's common to both Yaesu and Kenwood rigs? asks a member. The letter "T", he says, answering his own question. So what? Well, why not add a letter "S" to the "FT" Club designation? It would then look like FTS Club. Or maybe this would make it clearer: FTS and FTS. Then it could apply to both!!!

Sorry gentlemen, there are only 24 hours in a day! But would anyone else like to get into the act for the FTS part? It could be a golden opportunity. N4ML

THE INTERNATIONAL
FOX TANGO CLUB
MILTON LOWENS WA2AQQ/N4ML
248 LAKE DORA DRIVE
W. PALM BEACH, FLORIDA 33411

BULK RATE
U. S. POSTAGE
PAID
W. Palm Beach, FL.
PERMIT No. 285

FT NEWSLETTER

In this issue: (Year 8, Number 1) January, 1979

Editorial: New Year's Greetings...Basic ideas for improving the FT-101 Receiver...FT-7 Modifications...The 1800Hz SSB---the why and wherefore, including some reports on its operation...For Sale...More reactions to, and modifications for, the FT-901DM...Customs relief for Canadian hams (we hope)...An "insurance" modification for the FT-901 series...

Plus more in the Supplement, including a new Price List for Green Sheet No. 6.

In case your neighbor wonders why he did not receive this issue, remind him that all subscriptions expire Dec. 31. Basic dues are now \$6/yr.

FT NET MEETS SATURDAYS, 1700 UTC, 14,325 ± 5KHz

Dated PRINTED MATTER - Please do not Delay!

Printed in the U. S. A.

FT-620B ALIGNMENT NOTES

by Bruce Dehn WB70TQ via Ken Thompson K7DNF and the
Arizona 6-meter Association

The following instructions to get your FT-620B to perform as it should were supplied as indicated above. To put it mildly, the results on the sets of W7LNX and K7RKL were phenominal [they say]!

If available, put a wattmeter in the line to your load (dummy or antenna) while checking the transmitter.

1. Replace Q401 and Q403 on the RF-MIX board with 3N211 (preferred) or Sylvania ECG222 MOSFET's.
2. Replace C416 (.01) off Q402 with a 10 pF capacitor.
3. Replace C423 (.01) off Q403 with a 10 pF capacitor.
4. Adjust L401, L402, and L403 for peak incoming signal.
5. Adjust TC401, TC402 (near L402 and L403) for peak.
6. Adjust coil L406 for peak.
7. On MIC-AMP board behind mike gain control, turn L301 clockwise until the RX cuts off; then back it until RX just comes on again.
8. Adjust L407 (RF-MIX Board) for peak.
9. Using a mostly plastic screwdriver (such as GC-8276) adjust the following for peak in sequence given: TC405, TC404, TC403
10. In CW position, adjust L411, L413, L412, L414, and L415 for peak output. Do NOT held the key down for more than 5 seconds at a time.
11. Peak TC406 and L407.
12. Remove shield at left (over TX section).
13. Peak TC501 and TC502.
14. Repeat steps 9 through 13. Replace shield.
15. Adjust S-meter and noise blanker as per Manual.
16. Remove bottom cover and adjust L303 for maximum noise.
17. Adjust VR301 on MIC-AMP board if your signal has any carrier.
18. Adjust for automatic shutdown as per page 26 of the Manual.