

YAESU

**AM/FM/WFM
COMMUNICATIONS RECEIVER**

VR-160

OPERATING MANUAL



VERTEX STANDARD CO., LTD.

4-8-8 Nakameguro, Meguro-Ku, Tokyo 153-8644, Japan

VERTEX STANDARD

US Headquarters

10900 Walker Street, Cypress, CA 90630, U.S.A.

YAESU UK LTD.

Unit 12, Sun Valley Business Park, Winnall Close
Winchester, Hampshire, SO23 0LB, U.K.

VERTEX STANDARD HK LTD.

Unit 5, 20/F., Seaview Centre, 139-141 Hoi Bun Road,
Kwun Tong, Kowloon, Hong Kong

VERTEX STANDARD (AUSTRALIA) PTY., LTD.

Normanby Business Park, Unit 14/45 Normanby Road
Notting Hill 3168, Victoria, Australia

Contents

General Description	1	Scanning	44
Controls & Connections	2	Setting the Scan-Resume Mode	44
Keypad Functions	3	VFO Scanning	44
LCD Display	4	How to Skip (Omit) a Frequency during VFO Scan	47
Accessories & Options	5	Setting the Squelch Level during active Scanning Operation	47
Important Notice	6	Memory Scanning	48
Installation of Accessories	8	How to Skip (Omit) a Channel during Memory Scan Operation	49
Antenna Installation	8	Preferential Memory Scan	50
Installation of FNB-82LI Battery Pack	9	Memory Bank Scan	51
Battery Charging	10	Programmable (Band Limit) Memory Scan (PMS)	52
Installation of FBA-37 Alkaline Battery Case	11	Priority Channel Scanning (Dual Watch)	53
Battery Life Information	11	Automatic Lamp Illumination on Scan Stop	54
Operation	12	Band Edge Beeper	54
Switching Power On and Off	12	Smart Search Operation	56
Adjusting the Volume Level	12	Setting the Smart Search Mode	56
Squelch Adjustment	13	Storing Smart Search Memories	57
Selecting the Operating Band	14	Channel Counter Operation	58
Frequency Navigation	15	Setting the Channel Counter Sweep Width	59
AM and FM Broadcast Reception	16	CW Learning Feature	60
AF-DUAL Operation	17	CW Training Feature	62
Advanced Operation	18	Miscellaneous Setting	63
Keyboard Locking	18	Password	63
Adjusting the Keypad Beeper Volume Level	18	ATT (Front End Attenuator)	64
Keypad/LCD Illumination	19	Receive Battery Saver Setup	64
Changing the Receiving Mode	19	Wakeup Feature	65
Changing the Channel Steps	20	Disabling the BUSY Indicator	66
S-meter Squelch	21	Automatic Power-Off (APO) Feature	66
Checking the Battery Voltage	22	Automatic Power-On Feature	67
Checking the Temperature	22	My Bands Operation	68
Band Scope Operation	23	Changing the Status of the [VOL] Key	69
Tone Squelch/DCS Operation	24	S-meter Symbols	69
Tone Squelch Operation	24	Cloning	70
DCS Operation	26	Set (Menu) Mode	71
DCS Code Inversion	27	Appendix	88
Tone Search Scanning	28	External AM Radio Antenna Connections	88
Tone Squelch/DCS Bell Operation	29	Line-In Audion Connections	89
Programming the User Beep	30	Computer Connections	90
Memory Mode	32	S-meter Connections	91
Regular Memory Channel Operation	33	Specifications	92
Memory Storage	33	Reset Procedures	94
Memory Recall	34		
Labeling Memories	34		
Memory Offset Tuning	36		
Moving Memory Data to the VFO	36		
Masking Memories	37		
Memory Bank Operation	38		
Assigning Memories to a Memory Bank	38		
Memory Bank Recall	38		
Removing Memories from a Memory Bank	39		
Changing a Memory Bank's Name	39		
Memory Only Mode	40		
Special Memory Channel Operation	41		
Weather Broadcast Channels	41		
VHF Marine Channels	42		
Short-wave Broadcast Station Memory Channels	43		

GENERAL DESCRIPTION

The YAESU **VR-160** is a high-performance micro-miniature communications receiver covering frequencies from 100 kHz to 1299.995 MHz on the AM and FM (Wide and Narrow bandwidths) modes. Coverage includes the AM and FM broadcast bands, HF Short-wave Bands, VHF and UHF TV bands, the VHF AM aircraft band, and a wide range of commercial and public safety frequencies!

The incredibly small size allows you to take it anywhere - hiking, skiing, or walking around town. Its operating flexibility brings the user many avenues of listening enjoyment. The tiny **FNB-82LI** Lithium-Ion Battery Pack provides more than 20 hours of receiver operation.

The **VR-160** internal antenna bar provides good AM broadcast reception without the need of an external antenna.

The large High-resolution Dot Matrix LCD display provides clear, easily read frequency indication. The Band Scope function provides a high-resolution display of the relative signal strengths of up to ± 50 adjacent channels!

Additional features include the CTCSS and DCS squelch system, which help prevent false activation of the receiver by radar or spurious signals from other transmitters. A security Password may be set, which will allow you to turn on and operate your radio only after the Password is entered.

The S-Meter Squelch may be adjusted to open at a programmed signal level, thus reducing guesswork in setting the squelch threshold.

Additional equipment may be connected to the top panel **ACC** jack for expanded operation.





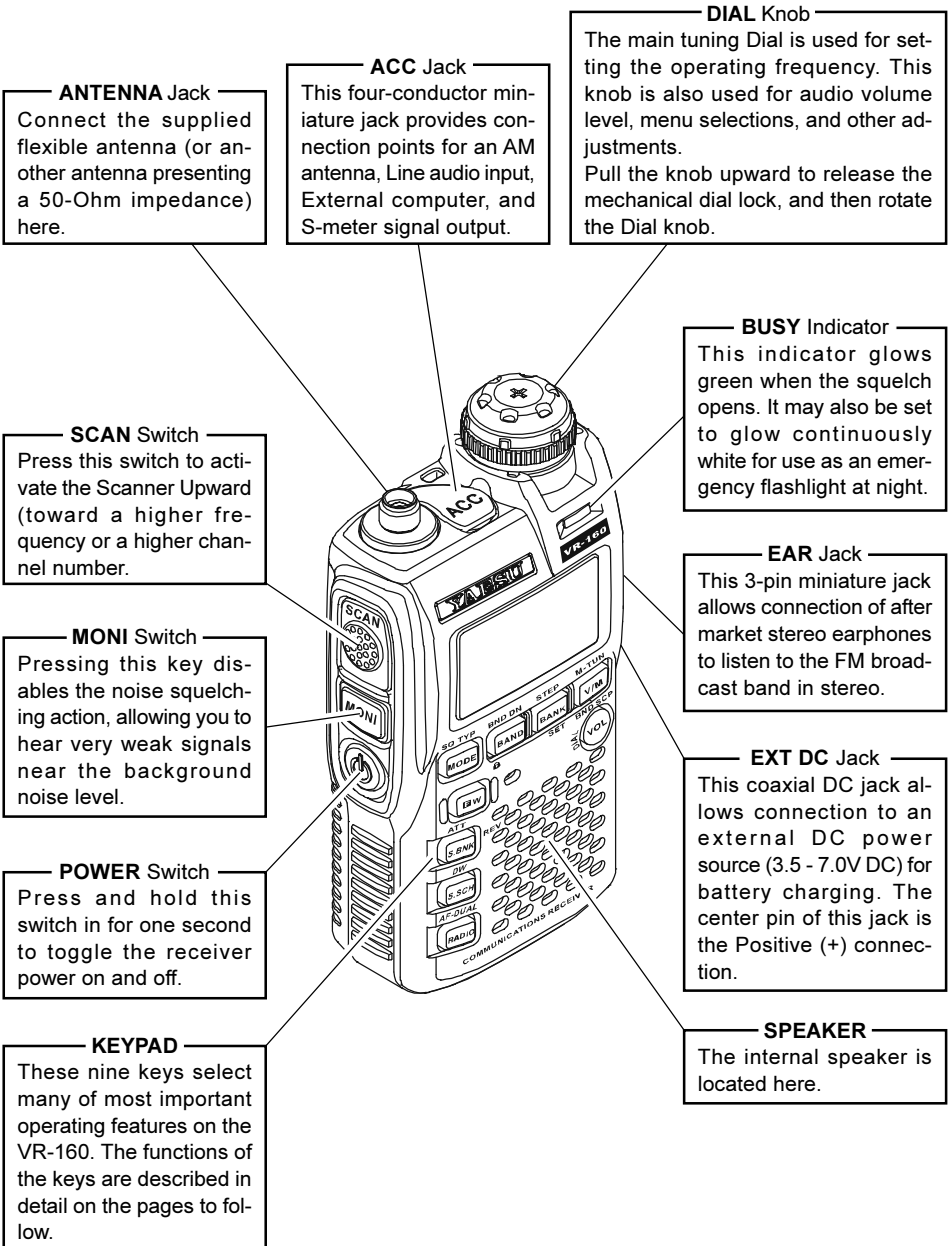



We appreciate your purchase of the **VR-160**, and encourage you to read this manual thoroughly, to learn about the many exciting features of your new YAESU communications receiver!

CONTROL & CONNECTIONS



CONTROL & CONNECTIONS

KEYPAD FUNCTIONS

KEY	PRIMARY FUNCTION (PRESS KEY)	SECONDARY FUNCTION (PRESS [F/W] + KEY)	THIRD FUNCTION (PRESS AND HOLD KEY)
	Switches the operating mode.	Activates Tone Squelch or DCS operation.	No Action.
	Moves operation to the next-highest frequency band. Activates the "Memory Bank" feature while in the Memory Recall mode.	Moves operation to the next-lowest frequency band.	Activates the key lockout feature.
	Activates the "Memory Bank" feature.	Selects the synthesizer steps to be used during VFO operation. Selects the Memory Bank while in the Memory Bank mode.	Enters the Set (Menu) Mode.
	Switches frequency control between the VFO and Memory Systems.	Activates the "Memory Tune" function while in the Memory Recall mode.	Activates the Band Scope feature while in the VFO mode.
	Activates the "Alternate" key function.	Disables the "Alternate" key function.	Activates the "Memory Write" mode (for memory channel storage).
	Engage the Special Search mode.	Activates the receiver "Attenuator" to reduce the receiving signal.	Monitor the opposite frequency while recalling the semi-duplex VHF Marine channel.
	Recalls the "Weather Broadcast" channels and Short-wave broadcast station channels.	Activates the Dual Watch feature.	No Action.
	Enter the Broadcast Reception mode. While in the Broadcast Reception mode, press the [BAND] key to toggle the receiving band between "AM" broadcast band and "FM" broadcast band.	Activates the AF-DUAL Operation.	Enables the antenna selection to be used.
	No Action.	Toggle the DIAL knob function between the "Frequency Control" and "Receiver Audio Control".	Rotate the DIAL knob while holding the [VOL] key to adjust the audio volume level.

CONTROL & CONNECTIONS

LCD DISPLAY

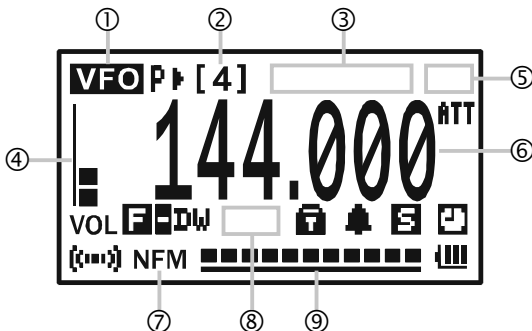

① FREQUENCY CONTROL

- VFO:** VFO Mode
- MEMO:** Memory Mode
- M-TN:** Memory Tune Mode
- BANK:** Memory Bank Mode
- PMS:** Programmable Memory Scan Mode

② OPERATING BAND NUMBER (while using VFO Mode)

MEMORY CHANNEL NUMBER (while using MR “Memory Recall” Mode)

③ OPERATING FREQUENCY (while using Alpha-Numeric “Tag” Operation)

④ VOLUME LEVEL

⑤ ACC JACK CONFIGURATION

- : Clone Data Input/Output
- : AM Antenna Input
- : Line Audio Input
- : External Computer Input/Output
- : S-meter Output

⑥ OPERATING FREQUENCY

⑦ OPERATING MODE

- NFM:** FM
- WFM:** Wide FM
- AM:** AM

⑧ SQUELCH TYPE & RADIO MODE

- DW:** Dual Watch Active
- TSQ:** Tone Squelch Active
- DCS:** Digital Code Squelch Active
- RTN:** Reverse Tone Squelch Active
- PR:** User Programmed Reverse CTCSS Decoder Active

⑨ S&P O METER

ICON

- P:** Priority Channel
- P**(Blinking): Sub frequency is received
(while using AF-DUAL operation)
- : Skip Memory Channel
- (Blinking): Preference Memory Channel
- ATT:** Attenuator Active
- : Secondary Keypad Active
- : Semi-Duplex Channel
- DW:** Dual Watch Active
- : Key Lock Active
- : Bell function Active
- : Battery Saver Active
- : Automatic Power-Off Active
- : Receiving an FM broadcast in Stereo
- : Battery Indicator

ACCESSORIES & OPTIONS

SUPPLIED ACCESSORIES

FNB-82LI	3.7 V, 1100 mAh Rechargeable Lithium Ion Battery Pack	1
PA-46C or PA-46U ※	AC Adapter	1
YHA-66	Antenna	1
Operating Manual		1
Warranty Card		1

AVAILABLE OPTIONS

① CSC-92	Soft Case
② FBA-37	Dry Cell Battery Case for 3 x “AA” Alkaline Cells
③ FNB-82LI	3.7 V, 1100 mAh Rechargeable Lithium Ion Battery Pack
④ PA-46C/U ※	AC Adapter
⑤ CN-3	BNC-to-SMA Adapter
⑥ ADAMS-5	Advanced Data Management System

※: “C” suffix is for use with 230 VAC (Type-C plug), and “U” suffix is for use with 230 VAC (Type-BF plug).

Availability of accessories may vary. Some accessories are supplied as standard per local requirements, while others may be unavailable in some regions. Consult your Yaesu dealer for details regarding these and any newly available options. Connection of any non-Yaesu-approved accessory, should it cause damage, may void the Limited Warranty on this apparatus.

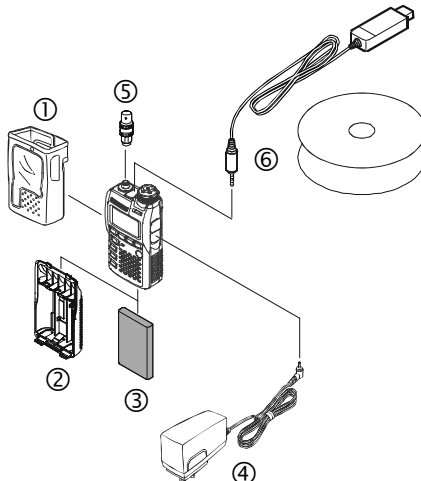

IMPORTANT NOTICE

Please read this manual carefully before using the VR-160 radio.



WARNING

Indicates Personal injury, fire hazard, or electric shock is Highly likely to occur.



CAUTION

Indicates Personal injury, fire hazard, or electric shock may occur.



NOTE

Indicates Equipment damage may occur.

 This symbol indicates an action that **must be performed** to maintain safe operation.

 This symbol indicates an action that **must be avoided** to maintain safe operation.

WARNING



Never use this equipment in a prohibited area, such as airplane, hospital etc.



Never attach metal parts, such as a paper clip, or a necklace etc. to this receiver.



Never operate this equipment while driving a vehicle, or motorcycle.



Never touch the Battery Pack or Battery Case with wet hands.



Never modify the Battery Pack.

CAUTION



When using the **FBA-37** Battery Case, install the batteries according to instructions. Check the polarity of the battery carefully.



This equipment is not waterproof. When splashed with water, turn off the power switch immediately, then thoroughly dry the equipment with a soft cloth.



Do not use any improper operating voltage.



In the event of abnormal operation, the smell of smoke etc., turn off the power switch immediately, and then remove the battery pack from the radio. Disconnect the battery charger from the AC outlet.



Do not modify this equipment.

IMPORTANT NOTICE

⚠ CAUTION ⚠



Replace the battery pack if it is damaged or deformed.



Use only the Vertex Standard **FNB-82LI** Battery Pack.



If charging is not completed even if after ample charge time is passed, disconnect the battery charger from the AC outlet immediately.



Use only the Vertex Standard **PA-46C/U** AC Adapter.



Keep the Battery Pack terminals clean.

⚠ NOTE ⚠



Do not throw this equipment.



Do not wipe the case with thinner and/or benzene.



Do not place this equipment near a heater.



Do not charge the battery with an improper battery charger.



Do not hold or swing this equipment around with the antenna.



Do not charge the battery in a place where flammable gas is generated.



Do not use this equipment at the crowded place.



Perform the battery charging where the ambient temperature range is +5 °C to +35 °C.



Do not expose this equipment to direct sunlight.



Properly recycle discarded battery packs after affixing tape across the terminals.



Do not place this equipment in a location exposed to dust and/or high humidity.

INSTALLATION OF ACCESSORIES

ANTENNA INSTALLATION

The supplied antenna provides good results over the entire frequency range of the transceiver. However, for enhanced base station medium-wave and shortwave reception, you may wish to connect an external (outside) antenna, as the supplied antenna is very small and cannot be expected to provide high performance at these frequencies.

To install the supplied antenna, hold the bottom end of the antenna and screw it onto the mating connector on the transceiver until it is snug. Do not over-tighten or use extreme force.

Notes:

When installing the supplied antenna, never hold the *upper* part of the antenna while screwing it onto the mating connector on the transceiver.

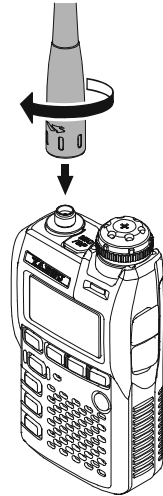

INSTALLATION OF ACCESSORIES

INSTALLATION OF FNB-82LI BATTERY PACK

The **FNB-82LI** is a high-performance Lithium-Ion battery providing high capacity in a *very* compact package. Under normal use, the **FNB-82LI** may be used for approximately 300 charge cycles, after which operating time may be expected to decrease. If you have an older battery that is displaying diminished capacity, you should replace the pack with a new one. Installation of the battery is easy and quick:

1. Slide the Battery Cover Latch to the Unlock position and then slide the Battery Cover toward the bottom to remove it.
2. Install the **FNB-82LI** into the Battery Compartment.
3. Replace the Battery Cover and then slide the Battery Cover Latch into the “Lock” position.

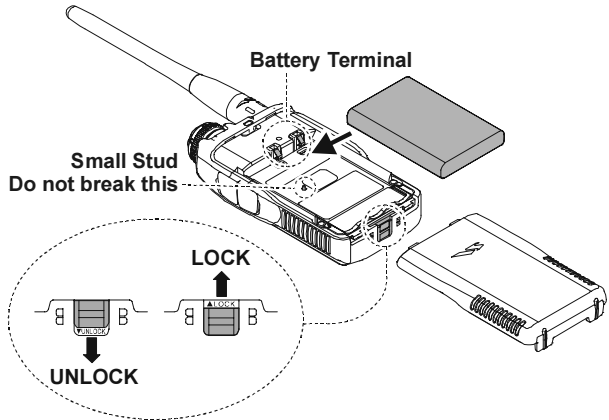

Important Note:

There is a small stud in the Battery Compartment of the VR-160. This stud is a switch for the battery detection. Please be careful not to break this stud while changing the battery.

CAUTION

- Risk of explosion if battery is replaced by incorrect type. Dispose of used batteries according to the instructions.
- Do not expose the Battery Pack to excessive heat such as direct sunshine, fire, or the like.
- Perform the battery charging when the ambient temperature range is +5 °C to +35 °C. Charging out of this range could cause damage to the battery pack.
- Use only the Vertex Standard Co., Ltd. Model **PA-46C/U** AC Adapter.

IMPORTANT NOTE

Always use the Vertex Standard Co., Ltd. Model **FNB-82LI** Battery Pack.

INSTALLATION OF ACCESSORIES

BATTERY CHARGING

If the battery has never been used, or its charge is depleted, it may be charged by connecting the **PA-46** AC Adapter, as shown in the illustration, to the **EXT DC** jack.

While the battery is being charged, the display will indicate “CHGING” and the **BUSY** indicator will glow red. The S-meter will deflect according to the charging status.

When charging is finished, the display will change to indicate “CHGFUL” and the **BUSY** indicator will glow green.

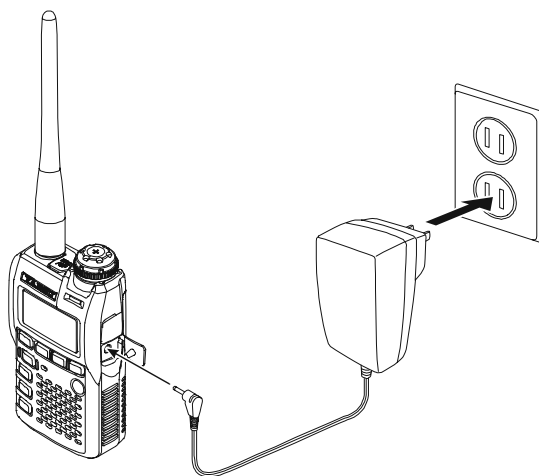

The **PA-46** is only designed for the charging of the **VR-160**'s battery, and is not suitable for other purposes. Please be advised that the **PA-46** may contribute noise to TV and radio reception in the immediate vicinity, so we do not recommend its use adjacent to such devices.

Important Note:

- 1) *Perform battery charging when the ambient temperature range is +5 °C to +35 °C. Charging out of this range could cause damage to the battery pack.*
- 2) *If the charge is not completed in three hours or if “CHG ERR” appears in the display, the battery may have deteriorated. Do not attempt to forcibly charge the battery, Please contact your Yaesu dealer.*
- 3) *If you do not use the VR-160 for a long time, remove the FNB-82LI Lithium-Ion battery pack from the VR-160, as battery leakage could cause damage to the VR-160 and FNB-82LI.*
- 4) *When an FNB-82LI Lithium-Ion battery pack is not used for a long time, please remove it from the transceiver. Also, while in storage, the charge will drain slightly over time and the battery should be recharged 50 % each six months.*

CHARGING
■■■■■■■■■■



CHG FULL
■■■■■■■■■■

CHG ERR

INSTALLATION OF ACCESSORIES

INSTALLATION OF FBA-37 ALKALINE BATTERY CASE (OPTION)

The optional **FBA-37** Battery Case allows operation of the **VR-160** using three “AA” size alkaline batteries.

When installing batteries, insert the (–) end first, then press in the (+) end so the battery snaps into place. Always replace all three batteries at the same time, paying attention to the polarity indicated inside the case.

The **FBA-37** must not be used with rechargeable cells. The **FBA-37** does not contain the thermal and over-current protection circuits (provided in the **FNB-82LI** Lithium-Ion Battery Pack) required when utilizing Ni-Cd and Ni-MH cells.

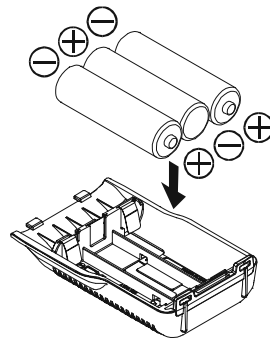

Important Note:

- 1) *The FBA-37 is designed for use only with AA-type Alkaline cells.*
- 2) *If you do not use the VR-160 for a long time, remove the alkaline batteries from the FBA-37, as battery leakage could cause damage to the VR-160 and FBA-37.*
- 3) *Never connect the external DC power supply to the VR-160, when the FBA-37 Battery Pack is installed in the VR-160.*

BATTERY LIFE INFORMATION

When the battery charge is almost depleted, a “L” icon will blink on the display. When the “L” icon blinks, it is recommended that you charge the battery soon.



OPERATING BAND	BATTERY LIFE (APPROX.)		BATTERY INDICATOR
	FNB-82LI	FBA-37	
Amateur Band*1	23 hours	28 hours	Full Battery Power Enough Battery Power Lower Battery Power Poor Battery Power (Blinking): Prepare to charge (or replace) the Battery
Broadcast Band*2	20 hours	25 hours	

*1: Receiving Ratio (1 : 3 = RX : Squelched)

*2: Continuous signal reception.

VOL Level: 10 (Factory Default)

The current battery voltage can be displayed manually on the display, via the Set Mode Item 22: DC VOLTAGE.

Battery capacity may be reduced during extremely cold weather operation. Keeping the radio inside your parka may help preserve the full charge capacity.

ADJUSTING THE VOLUME LEVEL

may change the [VOL] key function via Set Mode Item 60: VOLUME MODE. See page 86 for details.

SQUELCH ADJUSTMENT

The **VR-160**'s Squelch system allows you to mute the background noise when no signal is being received. The Squelch system makes “standby” operation more pleasant, and significantly reduces battery current consumption.

The Squelch system may be adjusted independently for the FM and Wide-FM (FM Broadcast) modes.

1. Press the [F/W] key, followed by the **MONI** switch on the left side of the radio. This provides a “Short-cut” to Set Mode Item 49: SQL LEVEL.
2. Now, rotate the **DIAL** knob to set the Squelch so that the background noise is just silenced (typically at a setting of about “1” or “2” for AM/FM, and “2” or “3” for Wide-FM/FM Broadcast/AM Broadcast). This is the point of maximum sensitivity to weak signals.

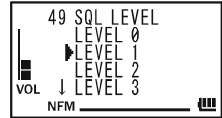
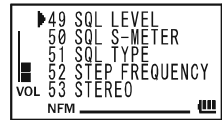

Note: Do not forget to pull the **DIAL** knob to rotate the **DIAL** knob.

3. When you are satisfied with the Squelch threshold setting, press the **MONI** switch briefly to save the new setting and exit to normal operation.



- 1) *The VR-160 squelch threshold level can be individually set on the AM mode, FM mode, Wide FM mode, and AM Broadcast mode.*
- 2) *A special “S-meter Squelch” feature is provided on the VR-160. This feature allows you to set the squelch so only signals exceeding a certain S-meter level will open the squelch. See page 21 for details.*

FREQUENCY NAVIGATION

The **VR-160** will initially be operating in the “VFO” mode. This is a channelized system which allows free tuning throughout the currently-selected operating band.

Two basic frequency navigation methods are available on the **VR-160**:

1) TUNING DIAL

Rotation of the **DIAL** knob allows tuning in the pre-programmed steps established for the current operating band. Clockwise rotation of the **DIAL** knob causes the **VR-160** to be tuned toward a higher frequency, while counter-clockwise rotation will lower the operating frequency.

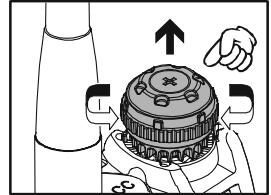

If you press the **[F/W]** key momentarily, then rotate the **DIAL** knob, frequency steps of 1 MHz will be selected. This feature is extremely useful for making rapid frequency excursions over the wide tuning range of the **VR-160**.

Note: Do not forget to pull the **DIAL** knob to rotate the **DIAL** knob.

2) SCANNING

From the VFO mode, press and hold in the **SCAN** switch for one second to show the VFO scanner bandwidth selections. Rotate the **DIAL** knob to select the desired bandwidth for the VFO scanner, press the **SCAN** switch briefly to begin scanning toward a higher frequency. The scanner will stop when it receives a signal strong enough to break through the Squelch threshold.

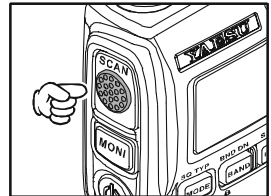

The **VR-160** will then hold on that frequency according to the setting of the “RESUME” mode (Set Mode Item 45: SCAN RESUME). See page 83 for more details regarding Scan Operation.

If you wish to reverse the direction of the scan (i.e. toward a lower frequency, instead of a higher frequency), just rotate the **DIAL** knob one click in the counter-clockwise direction while the **VR-160** is scanning. The scanning direction will be reversed. To revert to scanning toward a higher frequency once more, rotate the **DIAL** knob one click clockwise.

Press the **SCAN** switch briefly to stop the scanning.

Notice

The **VR-160** may receive very strong signals on the Image frequency. If you experience interference that you suspect may be coming in via an “image” path, you may calculate the possible frequencies using the formulas below. This information may be used in the design of effective countermeasures such as traps, etc.

$$\square 3.579545 \text{ MHz} \times n \quad \square 11.7 \text{ MHz} \times n \quad (n \text{ is an integer: } 1, 2, 3, \dots)$$

AM AND FM BROADCAST RECEPTION

AF-DUAL OPERATION

The AF-DUAL Operation allows you to monitor your desired frequency while receiving AM or FM broadcast stations.

When a signal is received in your desired frequency, the audio is output instead of the AM or FM Broadcast station. When the signal drops on your desired frequency, the AF-DUAL Operation is resumed as determined by the user settings in the below procedures.

1. Set the **VR-160** to the desired frequency using the VFO or Memory channel selection.
2. Press the **[FW]** key then press the **[RADIO]** key. This provides a “Short-cut” to Set Mode Item 02: AF DUAL.
3. Rotate the **DIAL** knob to select the resume mode of the AF-DUAL Operation. Available selections are:

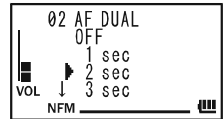

1 sec - 10 sec: When the selected time passes after your desired frequency signal drops, the AM or FM Broadcast station will be heard from the speaker and the AF-DUAL Operation is resumed.

OFF: Disable the AF-DUAL Operation.

Note: Do not forget to pull the **DIAL** knob to rotate the **DIAL** knob.

4. Press the **[RADIO]** key briefly to exit from the “Resume Mode Selection” mode of the AF-DUAL Operation.
5. Press the **[RADIO]** key again to activate AF-DUAL Operation. The small “**P**” icon appears above the volume level indicator on the display.
6. Press the **[BAND]** key to toggle the receiving band between “AM broadcast” and “FM broadcast”.
7. Rotate the **DIAL** knob to select the desired Broadcast station.
8. When a signal is received in your desired frequency, its audio is output to the speaker. The AM or FM Broadcast station will no longer be heard. When your desired frequency signal drops, the AM or FM Broadcast station will be heard from the speaker, and AF-DUAL Operation is resumed (your desired frequency is monitored while the AM broadcast station is heard from the speaker) according to the AF-DUAL Operation Resume mode selected in step 3 above.
9. You may monitor your desired frequency forcibly by holding the **MONI** switch.

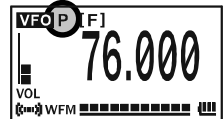

To disable the AF-DUAL Operation, just repeat the above procedure, rotating the **DIAL** knob to select “OFF” in step 3 above.



*1) You may change the frequency by rotating the **DIAL** knob while pressing the **MONI** switch.*

*2) When the **[V/M]** key is pressed, the **VR-160** recalls AM and FM Broadcast station memories only. In this case, the “**MEMO**” icon will blink.*

ADVANCED OPERATION

Now that you're mastered the basics of **VR-160** operation, let's learn more about some of the really neat features.

KEYBOARD LOCKING

In order to prevent accidental frequency change, various aspects of the **VR-160's** keys and switches may be locked out.

To activate the locking feature, press and hold in the [**BAND**] key for one second. The “**Ⓛ**” icon will appear on the LCD. To cancel locking, repeat this process.



ADJUSTING THE KEYPAD BEEPER VOLUME LEVEL

A keypad beeper provides useful audible feedback whenever a key is pressed. The keypad beeper level changes according to the receiver audio volume level setting. However, you may adjust the volume balance between the receiving audio and keypad beeper via Set Mode Item 11: BEEP LEVEL.

1. Press and hold in the [**BANK**] key for one second to enter the Set mode.

2. Rotate the **DIAL** knob to select Set Mode Item 11: BEEP LEVEL.

Note: Do not forget to pull the **DIAL** knob to rotate the **DIAL** knob.

3. Press the [**BANK**] key briefly to enable adjustment of this Item.

4. Rotate the **DIAL** knob to select the desired level.

5. When you have made your selection, press and hold in the [**BANK**] key for one second to save the new setting and return to normal operation.

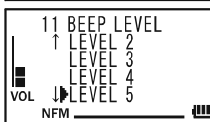
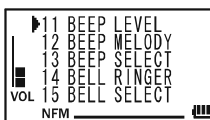

Additionally, if you want to turn the beep off:

1. Press and hold in the [**BANK**] key for one second to enter the Set mode.

2. Rotate the **DIAL** knob to select Set Mode Item 13: BEEP SELECT.

Note: Do not forget to pull the **DIAL** knob to rotate the **DIAL** knob.

3. Press the [**BANK**] key briefly to enable adjustment of this Item.

4. Rotate the **DIAL** knob to change the setting to “OFF”.

5. Press and hold in the [**BANK**] key for one second to save the new setting and return to normal operation.

6. If you wish to re-enable the Beeper, just repeat the above procedure, rotating the **DIAL** knob to select “KEY” or “KY+SCN” in step “4” above.

KEY: The beeper sounds when you press any key.

KEY+SCAN: The beeper sounds when you press a key or when the scanner stops.

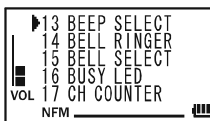

KEYPAD/LCD ILLUMINATION

Your **VR-160** includes a reddish illumination lamp which aids in nighttime operation. The red illumination yields clear viewing of the display in a dark environment, with minimal degradation of your night vision. Three options for activating the lamp are provided:

- KEY 2 sec - KEY 10 sec: Illuminates the Keypad/LCD for the selected illumination time when any key pressed.
- CONTINUOUS: Illuminates the Keypad/LCD continuously.
- OFF: Disables the Keypad/LCD lamp.

Here is the procedure for setting up the Lamp mode:

1. Press and hold in the **[BANK]** key for one second to enter the Set mode.
2. Rotate the **DIAL** knob to select Set Mode Item 27: LAMP.
Note: Do not forget to pull the **DIAL** knob to rotate the **DIAL** knob.
3. Press the **[BANK]** key briefly to enable adjustment of this Item.
4. Rotate the **DIAL** knob to select one of the three modes described above.
5. When you have made your choice, press and hold in the **[BANK]** key for one second to save the new setting and return to normal operation.

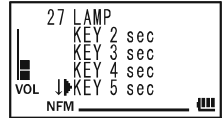
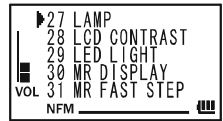

CHANGING THE RECEIVING MODE

The **VR-160** provides for automatic mode changing when the radio is tuned to different operating frequencies. However, should an unusual receiving situation arise in which you need to change to a different receiving mode, just press the **[MODE]** key. The receiving modes available are:

- AUTO: Automatic mode sets the default values for the selected frequency range.
- FM: Narrow-bandwidth FM (used for voice communication)
- AM: Amplitude Modulation
- W-FM: Wide-bandwidth FM (used for high-fidelity broadcasting)

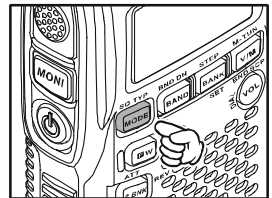

Unless you have a compelling reason to do so, leave the Automatic Mode Selection feature on, this will save time and trouble when changing bands. If you make a mode change for a particular channel or station, you can always store that one channel into memory, as the mode setting will be memorized along with the frequency information.

ADVANCED OPERATION

CHANGING THE CHANNEL STEPS

The **VR-160**'s frequency synthesizer provides the option of utilizing channel steps of 5/8.33/9/10/12.5/15/20/25/50/100 kHz per step (optional values differ depending on the band selected). A number of steps may be important to your operating requirements. Automatic ("AUTO") step selection is based on the current operating frequency. The **VR-160** is set up at the factory in the "AUTO" configuration, which probably is satisfactory for most operation. However, if you need to change the channel step increments, the procedure to do so is very easy.

1. Press and hold in the [**BANK**] key for one second to enter the Set mode.
2. Rotate the **DIAL** knob to select Set Mode Item 52: STEP FREQUENCY.

Note: Do not forget to pull the **DIAL** knob to rotate the **DIAL** knob.

3. Press the [**BANK**] key briefly to enable adjustment of this Item.
4. Rotate the **DIAL** knob to select the new channel step size.
5. When you have made your selection, press and hold in the [**BANK**] key for one second to save the new setting and return to normal operation.

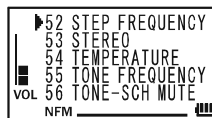

1) 9 kHz steps are available only when receiving on the BC band.

2) 8.33 kHz steps are available only when receiving on the Air band.

3) While operating on the BC band, you may only select channel steps of 9 kHz or 10 kHz; the other step selections are disabled.

4) 5 kHz steps are not available for use on 250 - 300 MHz, nor above 580 MHz.

S-METER SQUELCH

A special S-meter Squelch feature is provided on this radio. This feature allows you to set the squelch so only signals exceeding a certain S-meter level will open the squelch.

To set up the S-meter squelch circuit for operation, use the following procedure:

1. Press and hold in the **[BANK]** key for one second to enter the Set mode.
2. Rotate the **DIAL** knob to select Set Mode Item 50: SQL S-METER.
Note: Do not forget to pull the **DIAL** knob to rotate the **DIAL** knob.
3. Press the **[BANK]** key briefly to enable adjustment of this Item.
4. Rotate the **DIAL** knob to select the desired signal strength level for the squelch threshold (LEVEL 1 - LEVEL8 or OFF).
5. Press and hold in the **[BANK]** key for one second to save the new setting and return to normal operation.

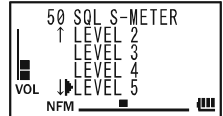
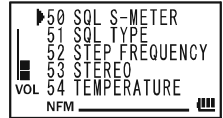

1) When the S-meter squelch is activated, the S-meter segment corresponding to the squelch threshold which was set by step 4 above will blink.

2) The receiver's squelch will open based on the higher of the levels set by the two squelch systems (Noise Squelch and S-meter Squelch).

For example:

a) If the Noise Squelch (SQL control) is set so that signals at a level of "S-3" will open the squelch, but the S-meter Squelch (Set Mode Item 80) is set to "LVL 5," the squelch will only open on signals which are "S5" or stronger on the S-meter.

b) If the S-meter Squelch is set to "S3," but the Noise Squelch is set to a high level which will only pass signals which are Full Scale on the S-meter, the squelch will only open on signals which are Full Scale on the S-meter. In this case, the Noise Squelch overrides the action of the S-meter Squelch.



ADVANCED OPERATION

CHECKING THE BATTERY VOLTAGE

The **VR-160**'s microprocessor includes programming which will detect the battery type and measure the current battery voltage.

1. Press and hold in the [**BANK**] key for one second to enter the Set mode.
2. Rotate the **DIAL** knob to select Set Mode Item 22: DC VOLTAGE.

Note: Do not forget to pull the **DIAL** knob to rotate the **DIAL** knob.

3. Press the [**BANK**] key briefly to display the battery type and the current DC voltage being supplied.

Lit: **FNB-82LI** is in use.

Edc: An external DC source is in use.

4. Press and hold in the [**BANK**] key for one second to return to normal operation.

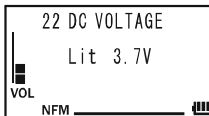
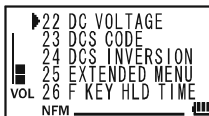

CHECKING THE TEMPERATURE

The **VR-160** can display the radio's inside case temperature, measured by an internal sensor.

1. Press and hold in the [**BANK**] key for one second to enter the Set mode.
2. Rotate the **DIAL** knob to select Set Mode Item 54: TEMPERATURE.

Note: Do not forget to pull the **DIAL** knob to rotate the **DIAL** knob.

3. Press the [**BANK**] key briefly to indicate the current temperature inside the transceiver's case.

4. Press the [**MODE**] key to select the preferred unit (F (°F) or C (°C)).

5. Press and hold in the [**BANK**] key for one second to save the new setting and exit to normal operation.

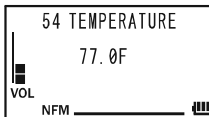
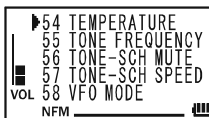

BAND SCOPE OPERATION

The Band Scope allows viewing operating activity on channels above or below the current operating channel in the VFO mode.

The display indicates the relative signal strength on channels immediately adjacent to the current operating frequency.

Two basic operating modes for the Band Scope are available:

1time: In this mode, the radio sweeps the current band once.

CONTINUOUS: In this mode, the radio sweeps the current band repeatedly until the **SCAN** switch is pressed, or the Band Scop is turned off.

SETTING UP THE BAND SCOPE MODE

1. Press and hold the **[BANK]** key for one second to enter the Set Mode.
2. Rotate the **DIAL** knob to select Set Mode Item 07: BAND SCOPE.
Note: Do not forget to pull the **DIAL** knob to rotate the **DIAL** knob.
3. Press the **[BANK]** key briefly to enable adjustment of this Set Mode Item.
4. Rotate the **DIAL** knob to select the desired Band Scope mode “1time” or “CONTINUOUS”.
5. Press and hold the **[BANK]** key for one second to save the new setting and exit to normal operation.

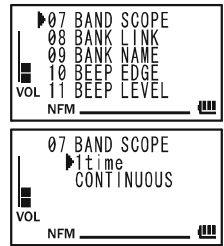

TO ACTIVATE THE BAND SCOPE

1. Press and hold the **[V/M]** key for one second to activate the Band Scope.
2. When the Band Scope is activated, press the **[MODE]** key to change the visible bandwidth. Available selections are ± 10 , ± 25 , and ± 50 channels (default: ± 25 channels). The visible bandwidth, however, depends on the selected channel step size, so match the default channel steps with the amateur band you are using.
3. Press the **[S.BNK]** key to toggle the receiver attenuator on and off, if desired.
4. Rotate the **DIAL** knob to bring the peak indication of the scope to the “▼” mark, you may monitor that signal. (In the “CONTINUOUS” mode, you have to stop the sweep by pressing the **SCAN** switch, at first).
Note: Do not forget to pull the **DIAL** knob to rotate the **DIAL** knob.
5. To turn the Band Scope off and operate on the center (displayed) channel, press and hold the **[V/M]** key for one second.

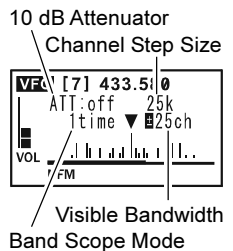

TONE SQUELCH/DCS OPERATION

TONE SQUELCH OPERATION

Some Two-way FM Radio Stations superimpose a very-low-frequency audio tone on the FM carrier. This helps prevent false activation of the station by radar or spurious signals from other transmitters. This tone system, called “Tone Squelch”, is included in your **VR-160**, and is very easy to activate.



Tone Squelch system setup involves two actions: setting the Tone Frequency and then setting of the Tone Mode. These actions are set up by using the [MODE] key or Set Mode Items 51: SQL TYPE and 55: TONE FREQUENCY.

1. Press the **[F/W]** key, then press the **[MODE]** key. This provides a “Short-cut” to Set Mode Item 51: SQL TYPE.

2. Rotate the **DIAL** knob to select “TSQL”. This activates the Tone Squelch system.

Note: Do not forget to pull the **DIAL** knob to rotate the **DIAL** knob.

3. When you have made your selection, press the **[MODE]** key to save the new setting.

4. Press and hold in the **[BANK]** key for one second to enter the Set mode.

5. Rotate the **DIAL** knob to select Set Mode Item 55: TONE FREQUENCY.

Note: Do not forget to pull the **DIAL** knob to rotate the **DIAL** knob.

6. Press the **[BANK]** key briefly to enable adjustment of the CTCSS frequency.

7. Rotate the **DIAL** knob until the display indicates the Tone Frequency you need to be using (ask the station owner/operator if you don’t know the tone frequency).

8. When you have made your selection, press and hold in the **[BANK]** key for one second to save the new settings and exit to normal operation. This is different from the usual method of restoring normal operation, and it applies only to the configuration of the Tone frequencies.

When the Tone Squelch is activated, the “**TSQ**” icon will appear in the display.



During Tone Squelch operation, you may set up the VR-160 so a ringing “bell” sound alerts you to an incoming call. See page 29 for details.

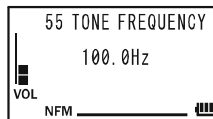
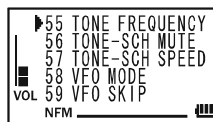
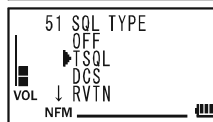
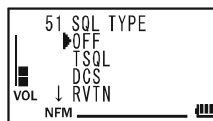

TONE SQUELCH/DCS OPERATION

TONE SQUELCH OPERATION

- ❑ Selecting “DCS” in step 2 above, will activate the DCS squelch system. We’ll discuss the Digital Code Squelch system shortly.
- ❑ Selecting “RVTN” in step 2 above, will activate the Reverse Tone Squelch system, which mutes your **VR-160** receiver when it receives a call from the radio sending a matched Tone Frequency. The “**TSQ**” icon will blink on the display when the Reverse Tone Squelch system is activated.
- ❑ Selecting “PR FRQ” in step 2 above, will activate the User programmed Reverse Tone Squelch, which mutes the **VR-160** receiver when it receives a signal containing a tone matching the Tone Frequency in Set Menu Item: 39: PR FREQUENCY. The “**PR**” icon will appear on the display when the User programmed Reverse CTCSS Decoder is activated.

CTCSS TONE FREQUENCY (Hz)					
67.0	69.3	71.9	74.4	77.0	79.7
82.5	85.4	88.5	91.5	94.8	97.4
100.0	103.5	107.2	110.9	114.8	118.8
123.0	127.3	131.8	136.5	141.3	146.2
151.4	156.7	159.8	162.2	165.5	167.9
171.3	173.8	177.3	179.9	183.5	186.2
189.9	192.8	196.6	199.5	203.5	206.5
210.7	218.1	225.7	229.1	233.6	241.8
250.3	254.1	–	–	–	–

TONE SQUELCH/DCS OPERATION

DCS OPERATION

Another form of tone access control is Digital Code Squelch, or DCS. It is a newer, more advanced tone system which generally provides more immunity from false paging than does Tone Squelch system. The DCS is built into your **VR-160**, and operation is very similar to that just described for Tone Squelch.



Just as in Tone Squelch operation, DCS requires that you set the Tone Mode to DCS and that you select a digital code. These actions are set up by using the [MODE] key or Set Mode Items 51: SQL TYPE and 23: DCS CODE.

1. Press the **[F/W]** key, then press the **[MODE]** key. This provides a “Short-cut” to Set Mode Item 51: SQL TYPE.
2. Rotate the **DIAL** knob until “DCS” appears on the display; this activates the DCS Encoder/Decoder.
Note: Do not forget to pull the **DIAL** knob to rotate the **DIAL** knob.
3. Press the **PTT** switch to save the new setting.
4. Press and hold in the **[BANK]** key for one second to enter the Set mode.
5. Rotate the **DIAL** knob to select Set Mode Item 23: DCS CODE.
6. Press the **[BANK]** key briefly to enable the adjustment of the DCS code.
7. Rotate the **DIAL** knob to select the desired DCS Code (a three-digit number). Ask the station owner/operator if you don’t know the DCS Code.
8. When you have made your selection, and hold in the **[BANK]** key for one second to save the new settings and exit to normal operation.

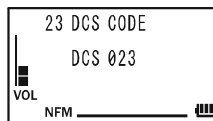
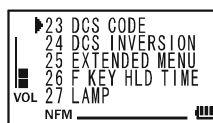
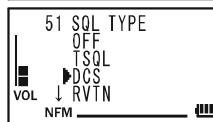
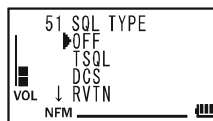

When the DCS is activated, the “**DCS**” icon will appear in the display.



During DCS operation, you may set up the VR-160 so a ringing “bell” sound alerts you to an incoming call. See page 29 for details.

DCS CODE										
023	025	026	031	032	036	043	047	051	053	
054	065	071	072	073	074	114	115	116	122	
125	131	132	134	143	145	152	155	156	162	
165	172	174	205	212	223	225	226	243	244	
245	246	251	252	255	261	263	265	266	271	
274	306	311	315	325	331	332	343	346	351	
356	364	365	371	411	412	413	423	431	432	
445	446	452	454	455	462	464	465	466	503	
506	516	523	526	532	546	565	606	612	624	
627	631	632	654	662	664	703	712	723	731	
732	734	743	754	-	-	-	-	-	-	

TONE SQUELCH/DCS OPERATION

DCS OPERATION

DCS CODE INVERSION

The DCS system was first introduced in the commercial LMR (Land Mobile Radio) service, where it is now in widespread use. DCS is sometime referred to by its different proprietary names, such as DPL® (Digital Private Line®, a registered trademark of Motorola, Inc.).

DCS uses a codeword consisting of a 23-bit frame, transmitted (subaudible) at a data rate of 134.4 bps (bit/sec). Occasionally, signal inversion can result in the complement of a code being sent or received. This prevents the receiver's squelch from opening with DCS enabled, as the decoded bit sequence would not match that selected for operation.

Typical situations that might cause inversion to occur are:

- Connection of an external receiver preamplifier.
- Operating through a repeater.
- Connection of an external linear amplifier.

Note that code inversion does not mean that any of the above listed equipment is defective!

In certain amplifier configurations, the output signal (phase) is inverted from the input. Small signal or power amplifiers having an odd number (1, 3, 5, etc.) of amplification stages may result in inversion of a transmitted or received DCS code. While under most circumstances this should not occur (amplifier designs and industry standards take this into account), if you find that your receiver squelch does not open when both you and the other station are using a common DCS code, you or the other station (but not both) can try the following:

1. Press and hold in the **[BANK]** key for one second to enter the Set mode.
2. Rotate the **DIAL** knob to select Set Mode Item 24: DCS INVERSION.

Note: Do not forget to pull the **DIAL** knob to rotate the **DIAL** knob.

3. Press the **[BANK]** key briefly to enable adjustment of this Set Mode Item.

4. Rotate the **DIAL** knob to select one of the following modes:

NORMAL: Receive the Normal DCS Tone.

REVERSE: Receive the Inverted DCS Tone.

BOTH: Receive both Normal and Inverted DCS Tones.

5. When you have made your selection, press and hold in the **[BANK]** key for one second to save the new settings and exit to normal operation.

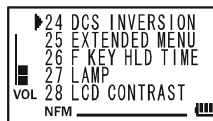

This is different from the usual method of restoring normal operation, and it applies only to the configuration of the CTCSS/DCS frequencies. Remember to restore the default setting to "NORMAL" when done.

TONE SQUELCH/DCS OPERATION

TONE SEARCH SCANNING

In operating situations where you don't know the Tone Frequency or DCS code being used by another station or stations, you can command the radio to listen to the incoming signal and scan in search of the tone being used. Two things must be remembered in this regard:

To scan for the tone in use:

1. Set the radio up for either Tone Squelch or DCS operation (see the previous discussions). In the case of Tone Squelch, “**TSQ**” will appear on the display; in the case of DCS, “**DCS**” will appear on the display.
2. Press and hold in the [**BANK**] key for one second to enter the Set mode.

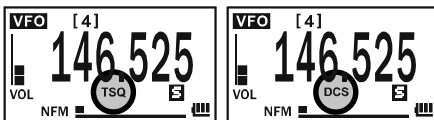

3. Rotate the **DIAL** knob to select Set Mode Item 55: TONE FREQUENCY when TONE SQL is selected, or Set Mode Item 23: DCS CODE during DCS operation.

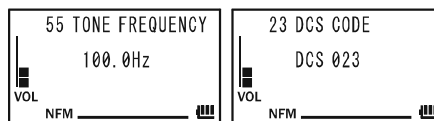

Note: Do not forget to pull the **DIAL** knob to rotate the **DIAL** knob.

4. Press the [**BANK**] key briefly to enable adjustment of the selected Set Mode Item.
5. Press the **SCAN** switch to start scanning for the incoming Tone Frequency or DCS code.
6. When the radio detects the correct tone or code, it will halt on that tone/code, and audio will be allowed to pass. Press the **SCAN** switch to lock in that tone/code, then press and hold in the [**BANK**] key for one second to exit to normal operation.



If the Tone Scan feature does not detect a tone or code, it will continue to scan indefinitely. When this happens, it may be that the other station is not sending any tone. You can press the SCAN switch to halt the scan at any time.

You may listen to the (muted) signal from the other station during Tone Scanning by changing Set Mode Item 56: TONE-SCH MUTE to “OFF.” See page 86 for details. You can also change the Tone Search scanning speed, using Set Mode Item 57: TONE-SCH SPEED. See page 86.

Tone Scanning works either in the VFO or Memory modes.

TONE SQUELCH/DCS OPERATION

TONE SQUELCH/DCS BELL OPERATION

During Tone Squelch or DCS operation, you may set up the **VR-160** so a ringing “bell” sound (or user programmed beep) alerts you to an incoming call. Here is the procedure for activating the Tone Squelch/DCS Bell:

1. Set the operating frequency to the desired channel.
2. Set the transceiver up for Tone Squelch or DCS operation, as described previously.
3. Press and hold in the **[BANK]** key for one second to enter the Set mode.
4. Rotate the **DIAL** knob to select Set Mode Item 15: BELL SELECT.
Note: Do not forget to pull the **DIAL** knob to rotate the **DIAL** knob.
5. Press the **[BANK]** key briefly to enable adjustment of this Set Mode Item.
6. Rotate the **DIAL** knob to set the desired “bell” sound. The available choices are BELL, USER BEEP1, USER BEEP2, USER BEEP3, or OFF (disable the Bell function).
Note: When User Beep (described later) does not register, USER BEEP1, USER BEEP2, or USER BEEP3 does not appear.
7. Press the **[BANK]** key briefly, then rotate the **DIAL** knob one click counter-clockwise to select Set Mode Item 14: BELL RINGER.
8. Press the **[BANK]** key briefly to enable adjustment of this Set Mode Item.
9. Rotate the **DIAL** knob to set the desired number of rings of the Bell. The available choices are 1 through 20 rings or CONT (continuous ringing).
10. Press the **PTT** switch momentarily to save the new setting and exit to normal operation.

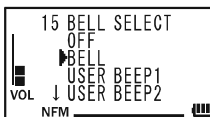
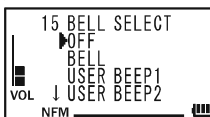

When you are called by a station whose transceiver is sending a Tone Frequency or DCS code which matches that set into your decoder, the Bell will ring in accordance with this programming.

When the Tone Squelch/DCS Bell is activated, the “🔔” icon will appear in the display.

To disable the Tone Squelch/DCS Bell function, select the setting of Set Mode Item 15: BELL SELECT to “OFF”.



TONE SQUELCH/DCS OPERATION

TONE SQUELCH/DCS BELL OPERATION

PROGRAMMING THE USER BEEP

Three User Beep Memories are provided, allowing you to create a unique original beep tone.

Each User Beep Memory can store up to 64 steps with three octaves (“C1” through “B3”).

1. Press and hold in the **[BANK]** key for one second to enter the Set mode.
2. Rotate the **DIAL** knob to select Set Mode Item 12: BEEP MELODY.
Note: Do not forget to pull the **DIAL** knob to rotate the **DIAL** knob.
3. Press the **[BANK]** key briefly to enable adjustment of this Set Mode Item.
4. Rotate the **DIAL** knob to select the memory slot into which you wish to store your programmed beep. Available selections are U1, U2, and U3. The previously stored beep will be displayed.
5. Press the **[V/M]** key to enable programming the beep. Press and hold the **[S.BNK]** key for one second to clear any previous beep, if desired.
6. Rotate the **DIAL** knob to select the first beep tone of the User Beep.
7. Press the **[V/M]** key, then rotate the **DIAL** knob to set the length of the first beep tone. Available selections are 1 (0.1 sec) - 250 (2.5 sec).
8. Press the **[V/M]** key to accept the first beep tone of the User Beep.
9. If you make a mistake, press the **[BAND]** key to back-space the cursor, then re-enter the correct beep tone or length.
10. Repeat steps 6 - 9 until you have completed the User Beep.
11. When there is a beep tone which you wish to delete, bring the cursor to that beep tone using the **[BAND]/[V/M]** key, then press the **[MODE]** key repeatedly until the “DEL” notation appears in the Memory Channel Number display slot. Press and hold in the **[MODE]** key for one second to delete that beep tone.
12. When you wish to add a beep tone into the beep tone strings, move the cursor to the desired place where you wish to enter the beep tone using the **[BAND]/[V/M]** key, then press the **[MODE]** key repeatedly until the “INS” notation is displayed in the Memory Channel Number display slot. Press and hold in the **[MODE]** key for one

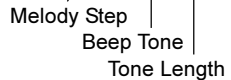
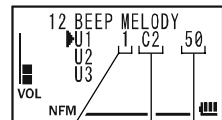
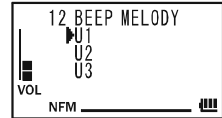
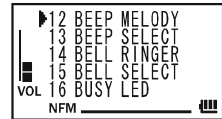

TONE SQUELCH/DCS OPERATION

TONE SQUELCH/DCS BELL OPERATION

second to add the beep tone.

13. Press and hold the [**S.BNK**] key for one second to delete all data after the current cursor position that was previously stored in the User Beep.
14. When you have programmed User Beep, press the [**BANK**] key briefly to confirm the User Beep.



You may check your work by monitoring the programmed User Beep. To do this, repeat steps 1 - 4 above, then press the [F/W] key.

MEMORY MODE (REGULAR MEMORY CHANNEL OPERATION)

The **VR-160** provides a wide variety of memory system resources. These include:

- ❑ “Regular” Memory Channels, which include:
 - 900 “Standard” memory channels, numbered “1” through “900”.
 - 100 “Frequency Skip Memories,” numbered “901” through “000”.
 - 50 sets of band-edge memories, also known as “Programmable Memory Scan” channels, labeled “L01/U01” through “L50/U50”.
 - 24 Memory Banks, labeled “B 1” through “B24”. Each Memory Bank can be assigned up to 100 channels from the “regular” memory channels.
- ❑ Special Memory Channels, which include:
 - 10 “Weather Broadcast” Channels.
 - 57 VHF Marine Channels.
 - 89 popular Short-wave Broadcast Station Memory Channels.

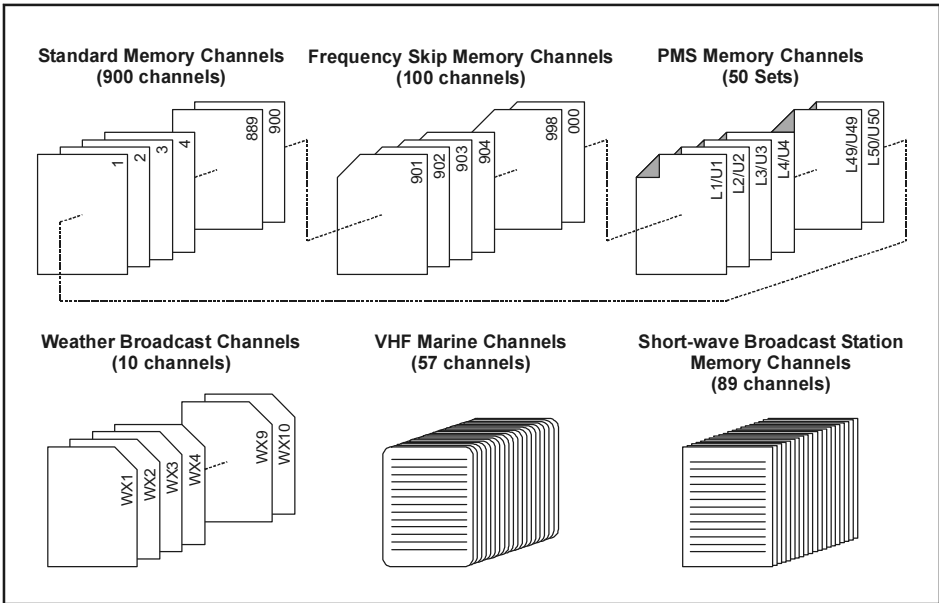

MEMORY MODE (REGULAR MEMORY CHANNEL OPERATION)

MEMORY STORAGE

1. Select the desired frequency while operating in the VFO mode. Be sure to set up any desired Tone Frequency or DCS code.
2. Press and hold in the [FW] key for 1/2 seconds.
3. Within five seconds of releasing the [FW] key, you need to make a decision regarding channel storage. The microprocessor will automatically select the next-available “free” channel (a memory register on which no data has been stored). If you do not wish to make a change and accept the “free” channel, proceed to step 4.



If you wish to select a different channel number into which to store the data, rotate the **DIAL** knob to select the desired memory channel.

Note: Do not forget to pull the **DIAL** knob to rotate the **DIAL** knob.

Advice: 1) You may jump 100 memory channels, if you're in a hurry (101 → 201 → 301 ...), by pressing the [BANK] key (multiple times, if necessary). Any channel that you see with a blinking channel number currently has no data written on it (i.e. the channel is “free”).

4. Press the [FW] key once more to store the frequency into memory.
5. You will still be operating in the “VFO” mode, so you may now enter other frequencies, and store them into additional memory locations, by repeating the above process.



1) You may change the automatic memory channel selection feature to select the “next-highest memory channel above the last-stored memory channel” instead of the “next-available ‘free’ channel” via the Set Mode Item 35: MR

WRITE MODE; see page 81.

2) When overwriting data into a memorized channel, the “M-WRT?” notation appears on the display. If you agree, press the [F/W] key. If not, press the [BANK] key to cancel the memory storage procedure.



3) You may disable the memory write function which prevents a memory write operation if you should accidentally perform a wrong key sequence via the Set Mode Item 33: MR PROTECT. See page 80 for details. When the memory write protect is activated, the “PROTCT” notation appears on the display while a memory write operation is being performed.

IMPORTANT NOTE

On rare occasions the memorized data may become corrupted by miss operation, or static electricity. When repairs are made the memory data may be lost. Please write down or record the memorized information so you will be able to restore it if needed.

MEMORY MODE (REGULAR MEMORY CHANNEL OPERATION)

MEMORY RECALL

1. While operating in the VFO mode, press the [V/M] key to enter the Memory mode.
2. Rotate the **DIAL** knob to select the desired channel.
Note: Do not forget to pull the **DIAL** knob to rotate the **DIAL** knob.
3. If you press the [F/W] key briefly, then rotate the **DIAL** knob, the memory channel will be selected in 10 channels per step.
4. To return to the VFO mode, press the [V/M] key.



You may change the step of the fast channel selection mode ([F/W] key + DIAL knob) via Set Mode Item 31: MR FAST STEP. See page 80 for details.

LABELING MEMORIES

You may wish to append an alpha-numeric “Tag” (label) to a memory or memories, to aid in recollection of the channel’s use (such as a club name, etc.). This is easily accomplished using the Set Mode.

1. Recall the memory channel on which you wish to append a label.
2. Press and hold in the [BANK] key for one second to enter the Set mode.
3. Rotate the **DIAL** knob to select the Set Mode Item 32: MR NAME.
Note: Do not forget to pull the **DIAL** knob to rotate the **DIAL** knob.
4. Press the [BANK] key briefly to enable adjustment of this Set Mode Item.
5. Rotate the **DIAL** knob to select the first digit of the desired label.
6. Press the [V/M] key to move to the next character.
7. Repeat steps 5 and 6 to program the remaining letters, numbers, or symbols of the desired label. A total of eight characters may be used in the creation of a label.
8. If you make a mistake, press the [BAND] key to back-space the cursor, then re-enter the correct letter, number, or symbol.
9. When you have completed the creation of the label, press and hold in the [BANK] key for one second to save the label and return to memory mode with the alpha-numeric “Tag” (label) displayed.

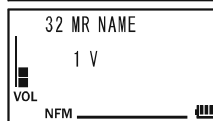
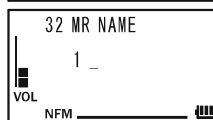

The large alpha-numeric “Tag” (label) appears on the display, and the small channel frequency indication appears at the right of the memory channel number.

MEMORY MODE (REGULAR MEMORY CHANNEL OPERATION)

LABELING MEMORIES



Press and hold in the MONI switch to reverse the character size between “Alpha-numeric Tag” and “frequency” to check the frequency of the “Tagged” memory channel more easily. Release the MONI switch to return to the normal display.



To disable the alpha-numeric Tag and enable the large frequency display:

1. Set the **VR-160** to the “MR” (Memory Recall) mode, and recall the memory channel on which you wish to disable the alpha-numeric Tag.
2. Press and hold in the **[BANK]** key for one second to enter the Set mode.
3. Rotate the **DIAL** knob to select the Set Mode Item 30: MR DISPLAY.

Note: Do not forget to pull the **DIAL** knob to rotate the **DIAL** knob.

4. Press the **[BANK]** key briefly to enable adjustment of this Item’s setting.
5. Rotate the **DIAL** knob to set this Set Mode Item to “MAIN:FREQ” (thus disabling the alpha-numeric display).
6. Press and hold in the **[BANK]** key for one second to save the new setting and return to memory mode with frequency display.

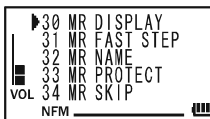

To enable the alpha-numeric Tag (label) display again, just repeat the above procedure, rotating the **DIAL** knob to select “MAIN:ALPHA” in step 5 above.



You may set up some memory channels to have their frequencies displayed, while others may be set to have their Name Tag displayed. The selection within Set Mode Item 49: MR DSP is not applied to all memory channels at once.

MEMORY MODE (REGULAR MEMORY CHANNEL OPERATION)

MEMORY OFFSET TUNING

Once you have recalled a particular memory channel, you may easily tune off that channel, as though you were in the “VFO” mode.

1. With the **VR-160** in the “MR” (Memory Recall) mode, select the desired memory channel.
2. Press the [**F/W**] key, then press the [**V/M**] key to activate the “Memory Tuning” feature. The “**MEMO**” icon will be replaced with “**M-TN**” and the Memory Channel number will be replaced with “**TUN**”.
3. Rotate the **DIAL** knob, as desired, to tune to a new frequency. The synthesizer steps selected for VFO operation on the current band will be the steps used during Memory Tuning.

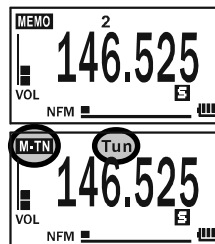

Note: Do not forget to pull the **DIAL** knob to rotate the **DIAL** knob.

4. If you wish to return to the original memory frequency, just press the [**V/M**] key briefly.
5. If you wish to store a new frequency set during Memory Tuning, just press and hold in the [**F/W**] key for 1/2 second, per normal memory storage procedure. The microprocessor will automatically set itself to the next-available clear memory location, and you then press [**F/W**] again to lock in the new frequency.



1) If you want to replace the original memory contents with those of the new frequency, be sure to rotate the DIAL knob to the original memory channel number!

2) Any required Tone Squelch/DCS changes, must be done before storing the data into the new (or original) memory channel location.

MOVING MEMORY DATA TO THE VFO

Data stored on memory channels can easily be moved to the VFO, if you like.

1. Select the memory channel containing the frequency data to be moved to VFO.
2. Press and hold in the [**F/W**] key for one second, then press the [**V/M**] key. The confirmation message (V-WRT?) will appear on the display. Press the [**F/W**] key to cancel the Moving Memory Data procedure, if desired.
3. Press the [**V/M**] key once more. The data will now have been copied to the VFO, although the original memory contents will remain intact on the previously stored channel.

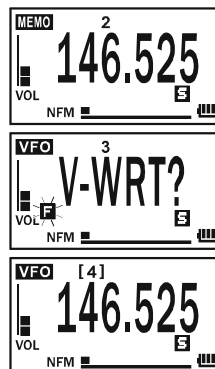

MEMORY MODE (REGULAR MEMORY CHANNEL OPERATION)

MASKING MEMORIES

There may be situations where you want to “Mask” memories so they are not visible during memory selection or scanning. For example, several memories used only in a city you visit infrequently may be stored, then “Masked” until you visit that city, at which time you can “Unmask” them for normal use (except for Memory Channel “1”).

1. Press the **[V/M]** key, if needed, to enter the “MR” (Memory Recall) mode.
2. Press and hold in the **[F/W]** key for 1/2 second, then rotate the **DIAL** knob to select the memory channel to be “Masked” from view.



Note: Do not forget to pull the **DIAL** knob to rotate the **DIAL** knob.

3. Press the **[S.SCH]** key. The confirmation message (M-DEL?) will appear on the display. Press the **[F/W]** key to cancel the Masking Memory procedure, if desired.
4. Press the **[S.SCH]** key once more. The display will revert to memory channel #1. If you rotate the **DIAL** knob to the location you just “Masked,” you will observe that it is now invisible.



To Unmask the hidden memory, repeat the above procedure. Press and hold in the **[F/W]** key for 1/2 second, rotate the **DIAL** knob to select the masked memory’s number, then press the **[S.SCH]** key to restore the memory channel’s data.



Watch out! You can manually store data over a “Masked” memory, deleting previous data, if you’re not careful. Use the “next available memory” storage technique to avoid over-writing a masked memory.

MEMORY MODE (REGULAR MEMORY CHANNEL OPERATION)

MEMORY BANK OPERATION

The large number of memories available in the **VR-160** could be difficult to utilize without some means of organizing them. Fortunately, the **VR-160** includes provision for dividing the memories into as many as 24 Memory Groups, so you can categorize the memories in a manner convenient to you. You may enter and exit the “Memory Group” mode by a single press of the [**BANK**] key, as we shall see below.

ASSIGNING MEMORIES TO A MEMORY BANK

1. Recall the memory channel to be assigned to a Memory Bank.
2. Press and hold in the [**F/W**] key for 1/2 second, then rotate the **DIAL** knob to select the Memory Bank number you want as the Memory Bank for this channel (“B 1” ~ “B24”, which is found before memory channel “1”).

Note: Do not forget to pull the **DIAL** knob to rotate the **DIAL** knob.

3. Press the [**F/W**] key momentarily.
4. At this point, the memory channel data is copied into the Memory Bank.



1) You may assign one memory channel into several

Memory Banks.

2) The PMS memory channels (L1/U1 through L50/U50) may not be assigned to a Memory Bank.

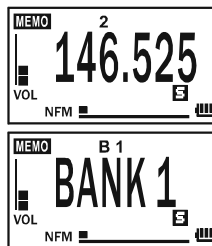
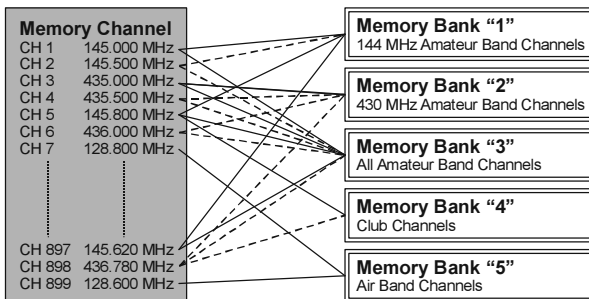

MEMORY BANK RECALL

1. Press the [**V/M**] key, if needed, to enter the “MR” (Memory Recall) mode.
2. Press the [**BANK**] key to activate the “Memory Bank” mode. The “**MEMO**” icon will be replaced with the “**BANK**” icon and a Memory Bank number will appear on the display.
3. Press the [**F/W**] key, and then press the [**BANK**] key.
4. Rotate the **DIAL** knob to select the desired Memory Bank (“BANK 1” through “BANK 24”).

Note: Do not forget to pull the **DIAL** knob to rotate the **DIAL** knob.

5. Press the [**BANK**] key. Now, as you rotate the **DIAL** knob to select memories, you will observe that you can only select memory channels in the

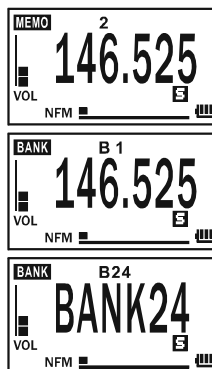

MEMORY MODE (REGULAR MEMORY CHANNEL OPERATION)

MEMORY BANK OPERATION

current memory bank.

- To change to another Memory Bank, press the [FW] key, then press the [BANK] key. Now rotate the DIAL knob to select the new Memory Bank, then press the [BANK] key again.
- To exit from Memory Bank operation, just press the [BANK] key. The “BANK” icon will be replaced with the “MEMO” icon, and operation will return to the “regular” Memory Recall mode, without utilization of the Memory Banks. The memories stored in the various Banks will remain in those banks. You do not need to store them again.



REMOVING MEMORIES FROM A MEMORY BANK

- Recall the memory channel to be removed from a Memory Bank.
- Press and hold the [FW] key for one second, then press the [S.SCH] key to remove the memory channel data from the Memory bank.

CHANGING A MEMORY BANK'S NAME

You may change the default Memory Bank Names, which are shown on the display while selecting the Memory Bank your desire.



The non assigned Memory Bank can not change the bank name. The non assigned Memory Bank shows the “-” icon between the Memory Bank number and Memory Bank name, to express a difference (in the example below, Memory Bank 1, 3, and 4).

- Press and hold in the [BANK] key for one second to enter the Set mode.
- Rotate the DIAL knob to select the Set Mode Item labeled 09: BANK NAME.

Note: Do not forget to pull the DIAL knob to rotate the DIAL knob.

- Press the [BANK] key briefly to enable adjustment of this Set Mode Item.
- Rotate the DIAL knob to select the memory bank on which you wish to change a label.
- Press the [V/M] key briefly to enable changing of the name tag.
- Rotate the DIAL knob to select the first digit of the desired label.
- Press the [V/M] key to move to the next character.
- Repeat steps 6 and 7 to program the remaining letters, numbers, or symbols of the desired label. A total of six characters may be used in the creation of a label.
- If you make a mistake, press the [BAND] key to backspace the

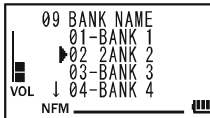
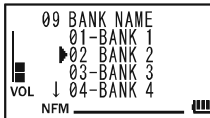
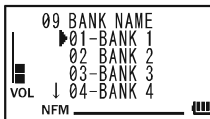
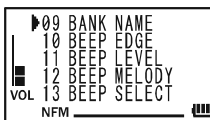

MEMORY MODE (REGULAR MEMORY CHANNEL OPERATION)

MEMORY BANK OPERATION

cursor, then re-enter the correct letter, number, or symbol.

- When you have completed the changes of the label, press and hold in the [BANK] key for one second to save the label and exit.

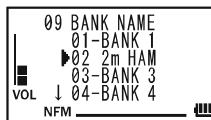

MEMORY ONLY MODE

Once memory channel programming has been completed, you may place the radio in a “Memory Only” mode, whereby VFO operation is impossible. This may be particularly useful during public-service events, where a number of operators may be using the radio for first time, and ultimate simplicity of channel selection is desired.

To place the radio into the Memory Only mode, turn the radio off. Now press and hold in the [V/M] key while turning the radio on. To return to normal operation, repeat the above power-on procedure.

MEMORY MODE (SPECIAL MEMORY CHANNEL OPERATION)

The **VR-160** provides Special Memory Channels, which made up of:

- 10 “Weather Broadcast” Channels.
- 281 VHF Marine Channels
- 89 popular Short-wave Broadcast Station Memory Channels.

You may assign the Special Memory Channels to a Memory Bank. See page 36 regarding Memory Bank Operation for details.

WEATHER BROADCAST CHANNELS

The VHF Weather Broadcast Station Memory Channel Bank has been pre-programmed at the factory, for quick selection of NOAA weather information stations.

1. Press the [**S.BNK**] key briefly to recall the Special Memory Menu.
2. Press the [**BAND**] key, repeatedly if necessary to select the “WX CH” (thus recalling the Weather Broadcast Memory Bank).
3. Rotate the **DIAL** knob to select the desired Weather Broadcast channel.



Note: Do not forget to pull the **DIAL** knob to rotate the **DIAL** knob.

4. If you wish to scan this bank to search for louder stations, just press the **SCAN** switch. When the scanner pauses on a station, press the **SCAN** switch once to halt the scan, or press it twice to restart the scan.
5. To exit to normal operation, press the [**S.BNK**] or [**V/M**] key.



1) In the event of extreme weather disturbances, such as storms and hurricanes, the NOAA (National Oceanic and Atmospheric Administration) sends a weather alert accompanied by a 1050 Hz tone and subsequent weather report on one of the NOAA weather channels. You may disable the Weather Alert tone via Set Mode Item 62: WX ALERT, if desired. See page 87.

2) You may append and display an alpha-numeric “Tag” (label) to a Weather Broadcast channel or channels. See page 35 regarding the labeling of a memory for details.

CH	FREQUENCY	CH	FREQUENCY
1	162.550 MHz	6	162.500 MHz
2	162.400 MHz	7	162.525 MHz
3	162.475 MHz	8	161.650 MHz
4	162.425 MHz	9	161.775 MHz
5	162.450 MHz	10	163.275 MHz

MEMORY MODE (SPECIAL MEMORY CHANNEL OPERATION)

VHF MARINE CHANNELS

Another special Memory Bank contains VHF Marine Channels, pre-programmed at the factory, for quick selection.

1. Press the [**S.BNK**] key briefly to recall the Special Memory Menu.
2. Press the [**BAND**] key, repeatedly if necessary, to select “INTVHF” (thus recalling the Marine Channel Memory Bank).
3. Rotate the **DIAL** knob to select any of 57 available VHF Marine Channels. When recalling a semi-duplex channel (such as Channel “1”), the “” icon will appear on the display.



Note: Do not forget to pull the **DIAL** knob to rotate the **DIAL** knob.

4. Press and hold in the [**S.BNK**] key for one second to monitor the opposite frequency while recalling the semi-duplex channel. In this case, the “” icon will blink. Press and hold in the [**S.BNK**] key for one second again to revert to normal monitoring.
5. To exit to normal operation, press the [**S.BNK**] or [**V/M**] key.

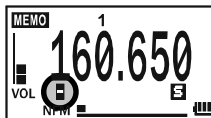

VHF MARINE CHANNEL FREQUENCY LIST

CH No.	FREQUENCY (MHz)		CH No.	FREQUENCY (MHz)		CH No.	FREQUENCY (MHz)		CH No.	FREQUENCY (MHz)	
1	156.050	160.650	15	156.750		60	156.025	160.625	74	156.725	
2	156.100	160.700	16	156.800		61	156.075	160.675	75	156.775	
3	156.150	160.750	17	156.850		62	156.125	160.725	76	156.825	
4	156.200	160.800	18	156.900	161.500	63	156.175	160.775	77	156.875	
5	156.250	160.850	19	156.950	161.550	64	156.225	160.825	78	156.925	161.525
6	156.300		20	157.000	161.600	65	156.275	160.875	79	156.975	161.575
7	156.350	160.950	21	157.050	161.650	66	156.325	160.925	80	157.025	161.625
8	156.400		22	157.100	161.700	67	156.375		81	157.075	161.675
9	156.450		23	157.150	161.750	68	156.425		82	157.125	161.725
10	156.500		24	157.200	161.800	69	156.475		83	157.175	161.775
11	156.550		25	157.250	161.850	70	156.525		84	157.225	161.825
12	156.600		26	157.300	161.900	71	156.575		85	157.275	161.875
13	156.650		27	157.350	161.950	72	156.625		86	157.325	161.925
14	156.700		28	157.400	162.000	73	156.675		87	157.375	161.975
									88	157.425	162.025

MEMORY MODE (SPECIAL MEMORY CHANNEL OPERATION)

SHORT-WAVE BROADCAST STATION MEMORY CHANNELS

A large number of Short-Wave Broadcast Station Memory Channels have also been pre-programmed at the factory, for convenient selection of broadcast stations.

1. Press the [**S.BNK**] key briefly to recall the Special Memory Menu.
2. Press the [**BAND**] key to select "RADIO" (thus recalling the Broadcast Station Channel Memory Bank).
3. Rotate the **DIAL** knob to select any of 89 available Broadcast Stations. The Station Name appears on the display, and its frequency appears at the right of the memory channel number.
Note: Do not forget to pull the **DIAL** knob to rotate the **DIAL** knob.
4. Press and hold in the **MONI** switch to reverse the character size between "Station Name" and "Frequency" to check the frequency more easily. Release the **MONI** switch to return to the normal display.
5. To exit to normal operation, press the [**S.BNK**] or [**V/M**] key.



BROADCAST STATION FREQUENCY LIST

Ch No.	Freq. (MHz)	MODE	Tag	Station Name	Ch No.	Freq. (MHz)	MODE	Tag	Station Name
1	6.030	AM	VOA	Voice of America	45	9.650	AM	SPAIN	Radio Exterior de Espana
2	6.160	AM	VOA	Voice of America	46	11.880	AM	SPAIN	Radio Exterior de Espana
3	9.760	AM	VOA	Voice of America	47	11.910	AM	SPAIN	Radio Exterior de Espana
4	11.965	AM	VOA	Voice of America	48	15.290	AM	SPAIN	Radio Exterior de Espana
5	9.555	AM	CANADA	Radio Canada International	49	6.055	AM	NIKKEI	Radio Nikkei
6	9.600	AM	CANADA	Radio Canada International	50	7.315	AM	NORWAY	Radio Norway International
7	11.715	AM	CANADA	Radio Canada International	51	9.590	AM	NORWAY	Radio Norway International
8	11.955	AM	CANADA	Radio Canada International	52	9.925	AM	NORWAY	Radio Norway International
9	6.195	AM	BBC	British Broadcasting Corporation	53	9.985	AM	NORWAY	Radio Norway International
10	9.410	AM	BBC	British Broadcasting Corporation	54	6.065	AM	SWEDEN	Radio Sweden
11	12.095	AM	BBC	British Broadcasting Corporation	55	9.490	AM	SWEDEN	Radio Sweden
12	15.310	AM	BBC	British Broadcasting Corporation	56	15.240	AM	SWEDEN	Radio Sweden
13	6.090	AM	FRANCE	Radio France International	57	17.505	AM	SWEDEN	Radio Sweden
14	9.790	AM	FRANCE	Radio France International	58	6.120	AM	FINLAN	Radio Finland
15	11.670	AM	FRANCE	Radio France International	59	9.560	AM	FINLAN	Radio Finland
16	15.195	AM	FRANCE	Radio France International	60	11.755	AM	FINLAN	Radio Finland
17	6.000	AM	DW	Deutsche Welle	61	15.400	AM	FINLAN	Radio Finland
18	6.075	AM	DW	Deutsche Welle	62	5.920	AM	RUSSIA	Voice of Russia
19	9.650	AM	DW	Deutsche Welle	63	5.940	AM	RUSSIA	Voice of Russia
20	9.735	AM	DW	Deutsche Welle	64	7.200	AM	RUSSIA	Voice of Russia
21	5.990	AM	ITALY	Italian Radio International	65	12.030	AM	RUSSIA	Voice of Russia
22	9.575	AM	ITALY	Italian Radio International	66	7.465	AM	ISRAEL	Israel Broadcasting Authority
23	9.675	AM	ITALY	Italian Radio International	67	11.585	AM	ISRAEL	Israel Broadcasting Authority
24	17.780	AM	ITALY	Italian Radio International	68	15.615	AM	ISRAEL	Israel Broadcasting Authority
25	7.170	AM	TURKEY	Voice of Trukey	69	17.535	AM	ISRAEL	Israel Broadcasting Authority
26	7.270	AM	TURKEY	Voice of Trukey	70	6.045	AM	INDIA	All India Radio (AIR)
27	9.560	AM	TURKEY	Voice of Trukey	71	9.595	AM	INDIA	All India Radio (AIR)
28	11.690	AM	TURKEY	Voice of Trukey	72	11.620	AM	INDIA	All India Radio (AIR)
29	9.660	AM	VATICN	Vatican Radio	73	15.020	AM	INDIA	All India Radio (AIR)
30	11.625	AM	VATICN	Vatican Radio	74	7.160	AM	CHINA	China Radio International (CRI)
31	11.830	AM	VATICN	Vatican Radio	75	7.190	AM	CHINA	China Radio International (CRI)
32	15.235	AM	VATICN	Vatican Radio	76	9.785	AM	CHINA	China Radio International (CRI)
33	5.955	AM	NEDERL	Radio Nederland	77	11.685	AM	CHINA	China Radio International (CRI)
34	6.020	AM	NEDERL	Radio Nederland	78	6.135	AM	KOREA	Radio Korea
35	9.895	AM	NEDERL	Radio Nederland	79	7.275	AM	KOREA	Radio Korea
36	11.655	AM	NEDERL	Radio Nederland	80	9.570	AM	KOREA	Radio Korea
37	5.985	AM	CZECH	Radio Liberty	81	13.670	AM	KOREA	Radio Korea
38	7.165	AM	CZECH	Radio Liberty	82	6.165	AM	JAPAN	Radio Japan
39	9.455	AM	CZECH	Radio Liberty	83	7.200	AM	JAPAN	Radio Japan
40	11.860	AM	CZECH	Radio Liberty	84	9.750	AM	JAPAN	Radio Japan
41	9.780	AM	PORTUG	Radio Portugal	85	11.860	AM	JAPAN	Radio Japan
42	11.630	AM	PORTUG	Radio Portugal	86	5.995	AM	AUSTRA	Radio Australia
43	15.550	AM	PORTUG	Radio Portugal	87	9.580	AM	AUSTRA	Radio Australia
44	21.655	AM	PORTUG	Radio Portugal	88	9.660	AM	AUSTRA	Radio Australia
					89	12.080	AM	AUSTRA	Radio Australia

SCANNING

The **VR-160** allows you to scan just the memory channels, the entire operating band, or a portion of that band. It will halt on signals encountered, so you can talk to the station(s) on that frequency, if you like.

Scanning operation is basically the same in each of the above modes. Before you begin, take a moment to select the way in which you would like the scanner to resume scanning after it halts on a signal.

SETTING THE SCAN-RESUME MODE

Eleven options for the Scan-Resume mode are available:

2.0sec - 10.0sec: In this mode, the scanner will halt on a signal it encounters, and will hold there for the selected resume time. If you do not take action to disable the scanner within that time period, the scanner will resume even if the stations are still active.

BUSY: In this mode, the scanner will halt on a signal it encounters. When the carrier has dropped because the other station(s) ceased transmission, the scanner will resume. In the case of constant-carrier signals like Weather Station broadcasts, the scanner will likely remain on this frequency indefinitely. The Scan Re-start Delay time (default interval: 2 seconds) is set by the Set Mode Item 44: SCAN RE-START.

HOLD: In this mode, the scanner will halt on a signal it encounters. It will not restart automatically; you must manually re-initiate scanning if you wish to resume.

To set the Scan-Resume mode:

1. Press and hold in the **[BANK]** key for one second to enter the Set mode.
2. Rotate the **DIAL** knob to select Set Mode Item 45: SCAN RESUME.

Note: Do not forget to pull the **DIAL** knob to rotate the **DIAL** knob.

3. Press the **[BANK]** key briefly to enable adjustment of this Set Mode Item.
4. Rotate the **DIAL** knob to select the desired scan-resume mode described above.
5. When you have made your selection, press and hold in the **[BANK]** key for one second to save the new setting and exit to normal operation.

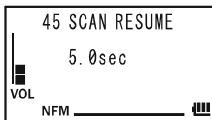
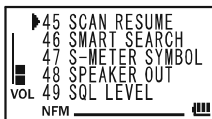

The default condition for this Set Mode Item is "5.0sec".

To set the Scan-Restart Delay Time:

1. Press and hold in the **[BANK]** key for one second to enter the Set mode.
2. Rotate the **DIAL** knob to select Set Mode Item 44: SCAN RE-START.

Note: Do not forget to pull the **DIAL** knob to rotate the **DIAL** knob.

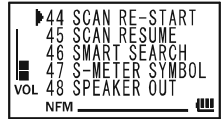

3. Press the **[BANK]** key momentarily to enable adjustment of this Set Mode Item.
4. Rotate the **DIAL** knob to select the desired Scan-Restart Delay Time. Available selections are 100ms - 900ms (100 ms/step) and 1.0sec - 10.0sec (0.5 sec/step).
5. When you have made your selection, press and hold in the **[BANK]** key for one second to save the new setting and exit to normal operation.

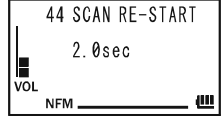

The default condition for this Set Mode Item is “2.0sec”.

VFO SCANNING

This mode allows you to scan on the VFO mode.

1. Select the VFO mode by pressing the **[V/M]** key, if necessary.
2. Press and hold in the **SCAN** switch for one second until the scanner VFO bandwidth setting appears on the screen.
3. Rotate the **DIAL** knob to select the bandwidth for the VFO scanner. Available selections are ± 1 MHz, ± 2 MHz, ± 5 MHz, BAND, ALL, and PMS-X.



± 1 MHz, ± 2 MHz, ± 5 MHz: The scanner will sweep frequencies within the selected bandwidth.

BAND: The scanner will sweep frequencies only on the current band (see chart below).

ALL: The scanner will sweep all frequencies between 100 kHz and 1300 MHz.

PMS-X: The scanner will sweep frequencies within the currently-selected PMS frequency pair. See page 52 for details.

Note: Do not forget to pull the **DIAL** knob to rotate the **DIAL** knob.

4. Press the **SCAN** switch briefly to start scanning.
5. When the scanner encounters a signal strong enough to open the squelch, the scanner will halt temporarily; the decimal point of the frequency display will blink during this “Pause” condition.
6. The scanner will then resume according to the Scan-Resume mode selected in the previous section.
7. To cancel scanning, press the **SCAN** switch or **[V/M]** key.



1) When you start scanning, the VR-160 will be changing frequency in the upward direction. If you want to change direction of the scan while it is underway, rotate the DIAL knob one click in the opposite direction (in this case, one click counter-clockwise). You'll see the scanner turn around and change frequency downward!

2) You may change the scanner's method of operation so the VFO frequency will jump to the low band edge of the next band when the VFO frequency reaches the high edge of the current band (or vice versa). See page 86 regarding Set Mode Item 58: VFO MODE.

OPERATING BAND [BAND NUMBER]		FREQUENCY RANGE
SW Band	[1]	0.1 - 30 MHz
50 MHz Ham Band	[2]	30 - 76 MHz
Air Band	[3]	76 - 137 MHz
144 MHz Ham Band	[4]	137 - 174 MHz
VHF-TV Band	[5]	174 - 222 MHz
Information Band 1	[6]	222 - 420 MHz
430 MHz Ham Band	[7]	420 - 470 MHz
UHF-TV Band	[8]	470 - 800 MHz
Information Band 2	[9]	800 - 1000 MHz
1200 MHz Ham Band	[a]	1000 - 1299.975 MHz

VFO SCANNING

HOW TO SKIP (OMIT) A FREQUENCY DURING VFO SCAN

If the VFO scan stops on a frequency or frequencies that you do not need (such as a spurious radiation from a television), such frequencies can be “skipped” during VFO scanning. A special “Frequency Skip Memory” bank is reserved to store these frequencies.

To skip a frequency during VFO scanning:

1. While VFO scanning is stopped on the frequency that you do not need, press and hold the **[F/W]** key for 1/2 second, then rotate the **DIAL** knob to select the desired Frequency Skip Memory channel (901 - 000). The microprocessor will automatically select the next-available “free” Frequency Skip Memory channel (a memory register on which no data has been stored). If you see a blinking channel number, it means that the current channel has no data written on it (i.e. the channel is “free”).
Note: Do not forget to pull the **DIAL** knob to rotate the **DIAL** knob.
2. Press the **[F/W]** key to store the frequency into the Frequency Skip Memory. It will now be ignored during VFO scanning.

To re-institute a frequency into the VFO scan loop:

1. Press the **[V/M]** key, if needed, to enter the “MR” (Memory Recall) mode.
2. Press and hold in the **[F/W]** key for 1/2 second, then rotate the **DIAL** knob to select the memory channel to be re-instituted.

Note: Do not forget to pull the **DIAL** knob to rotate the **DIAL** knob.

3. Press the **[S.SCH]** key. The confirmation message (M-DEL?) will appear on the display. Press the **[S.SCH]** key once more to delete the channel from the Frequency Skip Memory; this will restore the frequency into the VFO scan loop.



SETTING THE SQUELCH LEVEL DURING ACTIVE SCANNING OPERATION

The **VR-160** allows adjustment of the Squelch level “on the fly” while you are scanning.

1. While the scanner is engaged, press the **[F/W]** key. Then press the **MONI** switch (the current squelch level will appear on the display).
2. Rotate the **DIAL** to select the desired Squelch level.

Note: Do not forget to pull the **DIAL** knob to rotate the **DIAL** knob.

3. Press the **SCAN** switch briefly to save the new setting and exit to normal operation. In this case, pressing the **SCAN** switch this one time will not cause scanning to stop.



MEMORY SCANNING

Memory scanning is also easy to initiate:

1. Set the radio to the Memory mode by pressing the [V/M] key, if necessary.
2. Press and hold in the **SCAN** switch for one second until the Memory Scan mode appears on the display.
3. Rotate the **DIAL** knob to select the desired Memory Scan mode. Available selections are ALL CH, TAG1, TAG2, BAND, and PMS-X.



ALL CH: The scanner sweeps all Memory channels.

TAG1: The scanner sweeps only those Memory channels with the same first digit of the alpha/numeric tag as the first channel on which scanning started.

TAG2: The scanner sweeps only those Memory channels with the same first and second digits of the alpha/numeric tag as the first channel on which scanning started.

BAND: The scanner sweeps only those Memory channels which are memorized on the same operating band as the first channel on which scanning started.

PMS-X: The scanner will sweep frequencies within the currently-selected PMS frequency pair. See page 52 for details.

Note: Do not forget to pull the **DIAL** knob to rotate the **DIAL** knob.

3. Press the **SCAN** switch briefly to initiate scanning.
4. As with VFO scanning, the scanner will halt on any signal encountered that is strong enough to open the squelch; it will then resume scanning according to the Scan-Resume mode set previously. When there are no memory channels corresponding to the selected Memory Scan mode, the “MS ERR” notation will appear on the display.
5. To cancel scanning, press the **SCAN** switch or [V/M] key.



MEMORY SCANNING

HOW TO SKIP (OMIT) A CHANNEL DURING MEMORY SCAN OPERATION

As mentioned previously, some continuous-carrier stations like a Weather Broadcast station will seriously impede scanner operation if you are using the “Carrier Drop” Scan-Resume mode, as the incoming signal will not pause long enough for the transceiver to resume scanning. Such channels may be “Skipped” during scanning, if you like:

1. Recall the Memory Channel to be skipped during scanning.
2. Press and hold the **[BANK]** key for one second to enter the Set mode.
3. Rotate the **DIAL** knob to select the Set Mode Item 34: MR SKIP.
Note: Do not forget to pull the **DIAL** knob to rotate the **DIAL** knob.
4. Press the **[BANK]** key briefly to enable adjustment of this Set Mode Item.
5. Rotate the **DIAL** knob so as to select “SKIP.” The current Memory Channel will now be ignored during scanning. The “ONLY” selection is used for “Preferential Memory Scan,” described in the next column.
6. When you have made your selection, press and hold the **[BANK]** key for one second to save the setting and exit to normal operation.

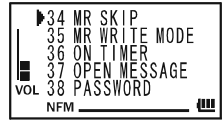

When you recall the “skipped” memory channel manually, a small “▶” icon will appear at the right of the “MEMO” icon, indicating it is to be ignored during scanning.



To re-institute a channel into the scanning loop, select “OFF” in step 5 above (the “Skipped” channel will, of course, still be accessible via manual channel selection methods using the **DIAL** knob in the “MR” (Memory Recall) mode, whether or not it is locked out of the scanning loop).

One Touch Memory Skip

If the scanner repeatedly stops on a channel due to temporary noise or interference while Memory Channel Scan is activated, it is a simple operation to mark it to be skipped (except for Memory Channel “1”).

To skip a channel temporarily, press the **[F/W]** key, and then press the **[V/M]** key while the scanner has stopped on the channel to be skipped. The scanner will immediately resume, and that channel will be assigned to the “skipped” memory channel.

To re-institute a channel into the scanning loop, perform the “How to Skip (Omit) a Channel during Memory Scan Operation” described previously, then select “OFF” in step 5.

MEMORY SCANNING

PREFERENTIAL MEMORY SCAN

The **VR-160** also allows you to set up a “Preferential Scan List” of channels which you can “flag” within the memory system. These channels are designated by a blinking “▶” icon when you have selected them, one by one, for the Preferential Scan List.

When you initiate memory scanning, the scan begins on a channel with the blinking “▶” icon appended; only those channels bearing the blinking “▶” icon will be scanned. If you initiate scanning on a channel that does not have the blinking “▶” icon appended, you will scan all channels including those with the blinking “▶” icon appended.

Here is the procedure for setting up and using the Preferential Scan List:

1. Recall the Memory Channel, which you wish to add to the Preferential Scan List.
2. Press and hold in the **[BANK]** key for one second to enter the Set mode.
3. Rotate the **DIAL** knob to select Set Mode Item 34: MR SKIP.
Note: Do not forget to pull the **DIAL** knob to rotate the **DIAL** knob.
4. Press the **[BANK]** key briefly to enable adjustment of this Set Mode Item.
5. Rotate the **DIAL** knob to select “ONLY.”
6. When you have made your selection, press and hold in the **[BANK]** key for one second to save the settings and exit to normal operation.



To initiate Preferential Memory Scan:

1. Press the **[V/M]** key momentarily to enter the Memory Recall mode, if you are not using memories already.
2. Rotate the **DIAL** to select any channel which has a blinking “▶” icon appended to the channel number.
Note: Do not forget to pull the **DIAL** knob to rotate the **DIAL** knob.
3. Press and hold in the **SCAN** switch for one second until Memory Scan mode appears on the display. Then rotate the **DIAL** knob to select the desired Memory Scan mode.



ALL CH: The scanner sweeps all Memory channels.

TAG1: The scanner sweeps only those Memory channels with the same first digit of the alpha/numeric tag as the first channel on which scanning started.

TAG2: The scanner sweeps only those Memory channels with the same first and second digits of the alpha/numeric tag as the first channel on which scanning started.

BAND: The scanner sweeps only those Memory channels which are memorized on the same operating band as the first channel on which scanning started.

MEMORY SCANNING

PMS-X: The scanner will sweep frequencies within the currently-selected PMS frequency pair. See next chapter for details.

- Press the **SCAN** switch briefly to initiate Preferential Memory Scanning. Only the channels that have a blinking “▶” icon appended to the channel number will be scanned.

MEMORY BANK SCAN

When the Memory Bank feature is engaged, the scanner sweeps only memory channels in the current Memory Bank. However, if the Memory Bank Link Scan feature is enabled, you may sweep the memory channels in several Memory Banks which you have selected.

To enable the Memory Bank Link Scan feature:

- Press and hold in the **[BANK]** key for one second to enter the Set mode.
- Rotate the **DIAL** knob to select the Set Mode Item labeled 09: BANK NAME.

Note: Do not forget to pull the **DIAL** knob to rotate the **DIAL** knob.

- Press the **[BANK]** key briefly to enable adjustment of this Set Mode Item.
- Rotate the **DIAL** knob to select the memory bank on which you wish to sweep using Memory Bank Link Scan.
- Press the **[F/M]** key briefly to append the “*” icon between Memory Bank number and Memory Bank name, indicating this Memory Bank will now be swept during Memory Bank Scan.
- Repeat steps 4 and 5 above, to append the “*” icon to any other Memory Banks you wish to sweep.
- Now, press and hold in the **[BAND]** key for one second to initiate the Memory Bank Link Scan.
- To remove a Memory Bank from the Memory Bank Link Scan, repeat steps 1 - 5 above, to delete the “*” icon from the Memory Bank number indication.

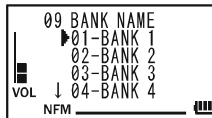
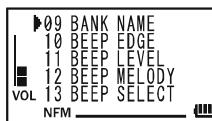

SCANNING

PROGRAMMABLE (BAND LIMIT) MEMORY SCAN (PMS)

This feature allows you to set sub-band limits for either scanning or manual VFO operation. For example, you might wish to set up a limit (in North America) of 144.300 MHz to 148.000 MHz, to prevent encroachment into the SSB/CW “Weak Signal” portion of the band below 144.300 MHz. Here’s how to do this:

1. Set the radio to the VFO mode by pressing the [V/M] key, if necessary.
2. Using the techniques learned earlier in the above procedures, store 144.300 MHz into Memory Channel #L1 (the “L” designates the Lower sub-band limit).
3. Likewise, store 148.000 MHz into Memory Channel #U1 (the “U” designates the Upper sub-band limit).
4. Press and hold in the **SCAN** switch for one second until the PMS bandwidth for the VFO scanner appears on the screen.
5. Rotate the **DIAL** knob to select the desired PMS frequency pair (PMSxx).
6. Press the **SCAN** switch briefly to initiate the Programmable (Band Limit) Memory Scan. The “MEMO” icon will be replaced with the “PMS” icon, and the PMS frequency pair number (“Pxx”) will appear in the display. Tuning and scanning will now be limited within the just-programmed range.



Note: Do not forget to pull the **DIAL** knob to rotate the **DIAL** knob.

7. 50 pairs of Band Limit memories, labeled L1/U1 through L50/U50 are available. You therefore can set upper and lower operation limits on a number of bands, if you like.
8. To cancel PMS scanning, press the [V/M] key.



PRIORITY CHANNEL SCANNING (DUAL WATCH)

The **VR-160**'s scanning features include a two-channel scanning capability, which allows you to operate on a VFO or Memory channel, while periodically checking a user-defined Memory Channel for activity. If a station is received on the Memory Channel which is strong enough to open the Squelch, the scanner will pause on that station in accordance with the Scan-Resume mode set via Set Mode Item 75: SCN.RSM. See page 56.

Here is the procedure for activating Priority Channel Dual Watch operation:



1. Press the **[V/M]** key momentarily to enter the Memory Recall mode, if you are not using memories already.
2. Press and hold in the **[F/W]** key for one second, then rotate **DIAL** knob to select the memory channel you wish to be the "Priority" channel.

Note: Do not forget to pull the **DIAL** knob to rotate the **DIAL** knob.

3. Press the **[BAND]** key. The "**PRI**" icon will appear above of the volume level indicator, indicating it is the Priority channel. 
4. Now set the **VR-160** for operation on another memory channel, or on a VFO frequency.
5. Press and hold in the **[V/M]** key for one second. The display will remain on the VFO or memory channel selected. However, the "**DW**" icon will appear on the display, and every five seconds the **VR-160** will check the Priority Channel for activity. If a station appears on the Priority Channel, the radio will pause on that channel, as described previously. 

The receiving time interval (ratio) between the current channel (or VFO frequency) and Priority channel may be customized via Set Mote Item 65: PRI.TMR.

To set the receiving time interval:

1. Press and hold in the **[BANK]** key for one second to enter the Set mode.
2. Rotate the **DIAL** knob to select Set Mode Item 65: PRI.TMR. **Note:** Do not forget to pull the **DIAL** knob to rotate the **DIAL** knob. 
3. Press the **[BANK]** key momentarily to enable adjustment of this Set Mode Item.
4. Rotate the **DIAL** knob to select the desired time interval. Available selections are 0.1S - 0.5S (0.5S/step) and 1.0S - 10S (0.5S/step). 
5. When you have made your selection, press the **PTT** switch to save the new setting and exit to normal operation.

The default condition for this Set Mode Item is "5.0S."

SCANNING

AUTOMATIC LAMP ILLUMINATION ON SCAN STOP

The **VR-160** will automatically illuminate the LCD Lamp whenever the scanner stops on a signal; this allows you to see the frequency of the incoming signal better at night. Note that this will, of course, increase the battery consumption, so be sure to switch it off during the day (the default condition for this feature is “ON”).

The procedure for disabling the Scan Lamp is:

1. Press and hold in the [**BANK**] key for one second to enter the Set mode.
2. Rotate the **DIAL** knob to select Set Mode Item 43: SCAN LAMP.
Note: Do not forget to pull the **DIAL** knob to rotate the **DIAL** knob.
3. Press the [**BANK**] key briefly to enable adjustment of this Set Mode Item.
4. Rotate the **DIAL** knob to set this Set Mode Item to “OFF.”
5. When you have made your selection, press and hold in the [**BANK**] key for one second to save the setting and exit to normal operation.

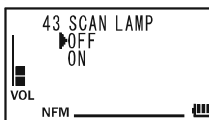

BAND EDGE BEEPER

The **VR-160** will automatically “beep” when a band edge is encountered during scanning (either in standard VFO scanning or during PMS operation). You may enable this feature (band edge beeper) when the frequency reaches the band edge while selecting the VFO frequency using the **DIAL** knob.

The procedure for enabling the Band-Edge Beeper is:

1. Press and hold in the [**BANK**] key for one second to enter the Set mode.
2. Rotate the **DIAL** knob to select Set Mode Item 12: BEEP EDGE.
Note: Do not forget to pull the **DIAL** knob to rotate the **DIAL** knob.
3. Press the [**BANK**] key briefly to enable adjustment of this Set Mode Item.
4. Rotate the **DIAL** knob to set this Set Mode Item to “ON.”
5. When you have made your selection, press and hold in the [**BANK**] key for one second to save the setting and exit to normal operation.

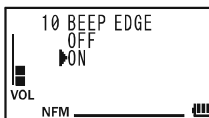
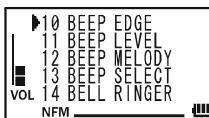

SMART SEARCH OPERATION

The Smart Search feature allows you to load frequencies automatically where activity is encountered by your radio. When Smart Search is engaged, the **VR-160** will search above and below your current frequency, storing active frequencies as it goes (without stopping on them even momentarily). These frequencies are stored into a special Smart Search memory bank, consisting of 31 memories (15 above the current frequency, 15 below the current frequency, plus the current frequency itself).

Two basic operating modes for Smart Search are available:

SINGLE: In this mode, the transceiver will sweep the current band once in each direction starting on the current frequency. All channels where activity is present will be loaded into the Smart Search memories, whether or not all 31 memories are filled. The search will stop after one sweep in each direction.

CONTINUOUS: In this mode, the transceiver will make one pass in each direction as with One-Shot searching. However, if all 31 channels are not filled after the first sweep, the radio will continue sweeping until they are all filled.

SETTING THE SMART SEARCH MODE

1. Press and hold in the **[BANK]** key for one second to enter the Set mode.

2. Rotate the **DIAL** knob to select Set Mode Item 46: SMART SEARCH.

Note: Do not forget to pull the **DIAL** knob to rotate the **DIAL** knob.

3. Press the **[BANK]** key briefly to enable adjustment of this Set Mode Item.

4. Rotate the **DIAL** knob to select the desired Smart Search mode (see above).

5. When you have made your selection, press and hold in the **[BANK]** key for one second to save the setting and exit to normal operation.

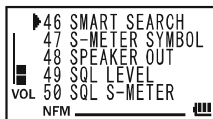

SMART SEARCH OPERATION

STORING SMART SEARCH MEMORIES

1. Set the radio to the VFO mode. Be sure that you have the Squelch adjusted properly (so that band noise is quieted).
2. Press the [**S.SCH**] key briefly, then rotate the **DIAL** knob to select the “S SRCH (Smart Search) Mode.”

Note: Do not forget to pull the **DIAL** knob to rotate the **DIAL** knob.

3. Press the [**S.SCH**] key again to enter the Smart Search mode.
4. Press and hold the [**BAND**] key for one second to begin the Smart Search scanning.
5. As active channels are detected, you will observe the number of “loaded” channels increasing in the regular memory channel window.
6. Depending on the mode you set for Smart Search operation (“SINGLE” or “CONTINUOUS”), the Smart Search scan will eventually terminate, and the LCD will revert to Smart Search Memory Channel “C.”
7. To recall the Smart Search memories, rotate the **DIAL** knob to choose from among the Smart Search memories.
8. To return to normal operation, just press the [**S.SCH**] key.



Smart Search is a great tool when visiting a city for the first time. You don't need to spend hours looking up repeater frequencies from a reference guidebook...just ask your VR-160 where the action is!

CHANNEL COUNTER OPERATION

The Channel Counter allows measuring of the frequency of a nearby transmitter, without knowing that frequency in advance. The frequency can be measured by bringing the **VR-160** close to the transceiver which is transmitting.

The **VR-160** performs a high-speed search within a ± 5 MHz range from the frequency displayed on the LCD. When the strongest signal in that range is identified, the **VR-160** displays the frequency of that (strongest) signal, and writes it into the special “Channel Counter” memory.

Note: This Channel Counter is designed to provide an indication of the operating frequency of the incoming signal, one that is close enough to allow the user, thereafter, to tune precisely to the other station’s frequency. This feature is not, however, designed to provide a precise determination of the other station’s frequency.

1. Set the radio to the VFO mode in the predicted frequency range for the transmitter to be measured.
2. Bring the **VR-160** into close proximity to the transmitter to be measured.
3. Rotate the **DIAL**, while pressing and holding in the **[MODE]** key, to select the “CH CNT (Channel Counter) mode.”



- Note:* Do not forget to pull the **DIAL** knob to rotate the **DIAL** knob.

4. Release the **[MODE]** key to begin the Channel Counter; the frequency of the nearby station will be displayed. When the channel counter is active, a 50 dB receiver front-end attenuator will be engaged. Therefore, only stations in close proximity may have their frequencies measured using this feature.
5. If it isn’t possible to determine the signal’s frequency, the transceiver will return to the frequency on which you were operating when you started Channel Counter operation.
6. When you are finished, just press the **[MODE]** key. The radio will exit from Channel Counter operation.



CHANNEL COUNTER OPERATION

SETTING THE CHANNEL COUNTER SWEEP WIDTH

You may change the bandwidth of the Channel Counter. Available selections are ± 5 , ± 10 , ± 50 , and ± 100 MHz (default: ± 5 MHz).

Here is the procedure for setting the Channel Counter Bandwidth:

1. Press and hold in the **[BANK]** key for one second to enter the Set mode.
2. Rotate the **DIAL** knob to select Set Mode Item 17: CH CNT.

Note: Do not forget to pull the **DIAL** knob to rotate the **DIAL** knob.

3. Press the **[BANK]** key momentarily to enable adjustment of this Set Mode Item.
4. Rotate the **DIAL** knob to select the desired bandwidth.
5. When you have made your selection, press the **PTT** switch to save the new setting and exit to normal operation.

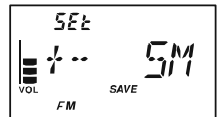

CW LEARNING FEATURE

The **VR-160** provides a CW learning function, which sends the designated Morse Code via the sidetone (heard in the speaker) to help your CW learning.

1. Press and hold in the [**BANK**] key for one second to enter the Set mode.

2. Rotate the **DIAL** knob to select Set Mode Item 19: CW LEARNING.



Note: Do not forget to pull the **DIAL** knob to rotate the **DIAL** knob.

3. Press the [**BANK**] key briefly to activate the CW learning function.

4. Press the [**MODE**] key to select the Training mode:

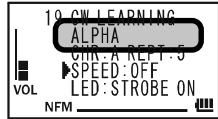

ALPHA: Sends the Alphabet characters

ALPHA AUTO: Sends the Alphabet characters (move to next character automatically)

NUMBER: Sends the Numeric characters

NUMBER AUTO: Sends the Numeric characters (move to next character automatically)

SYMBOL: Sends the Symbol characters

SYMBOL AUTO: Sends the Symbol characters (move to next character automatically)

5. Rotate the **DIAL** knob to select the Morse speed. You may select the units of the code speed between “CPM (characters per minute)” and “WPM (Words per minute)” by pressing the [**V/M**] key.

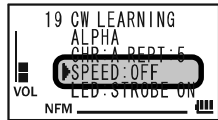

6. Press the [**BAND**] key to switch the flashing of the STROBE LED (white) on and off.

7. Press the [**S.BNK**] key to move the cursor to “CHR”. Rotate the **DIAL** knob to select the CW code which you want to learn and press the [**V/M**] key select the repetition time (1 - 9) of the sending.

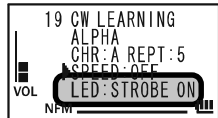

8. Press the [**F/W**] key to begin generating the selected code characters the designated number of times.



9. If one of the “AUTO” modes is selected in step 4 above, you may change the direction of the character rotation by tuning the **DIAL** knob.

10. You may adjust the CW sidetone audio level by rotating the **DIAL** knob while pressing and holding the [**VOL**] key.

11. If one of the “AUTO” modes is not selected in step 4 above, press the [**F/W**] key to send again, or select another code by rotating the **DIAL** knob and press the [**F/W**] key to begin generation.

If one of the “AUTO” modes is selected in step 4 above, press the [**F/W**] key to stop the CW generation.

12. To stop the CW generation, press the [**F/W**] key again.

13. To disable the CW learning feature, press and hold in the [**BANK**] key for one second.

CW LEARNING FEATURE



1) The “CPM” selection is based on the international “PARIS” standard, which stipulates five characters per word.

2) You may adjust the CW sidetone pitch via Set Mode Item 20: CW PITCH.

Available selections are 400 - 1000 Hz (50 Hz/step).

CW TRAINING FEATURE

The **VR-160** provides another CW learning function; call it a CW Training feature, which sends random Morse Code via the sidetone (heard in the speaker), so you can improve your CW proficiency.

1. Press and hold in the [**BANK**] key for one second to enter the Set mode.
2. Rotate the **DIAL** knob to select Set Mode Item 21: CW TRAINING.

Note: Do not forget to pull the **DIAL** knob to rotate the **DIAL** knob.

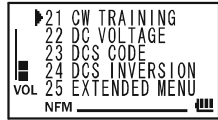

3. Press the [**BANK**] key briefly to activate the CW Training feature.
4. Press the [**MODE**] key to select the Training mode (displayed in fine print at the upper edge of the LCD):

ALPHA 5CHR: Sends five Alphabet characters only

ALPHA REPT: Sends Alphabet characters only (Repeatedly)

NUMER 5CHR: Sends five Numeric characters only

NUMER REPT: Sends Numeric characters only (Repeatedly)

MIX 5CHR: Sends five Alphabet, Numeric, “?”, and “/” characters (Mixed)

MIX REPT: Sends Alphabet, Numeric, “?”, and “/” characters (Mixed, Continuously in groups of five)

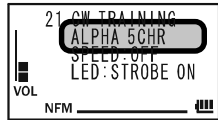

5. Rotate the **DIAL** knob to select the Morse speed. You may select the units of the code speed between “CPM (characters per minute)” and “WPM (Words per minute)” by pressing the [**V/M**] key.



6. Press the [**BAND**] key to switch the flashing of the STROBE LED (white) on and off.



7. Press the [**F/W**] key to begin generation of the code characters and the generated characters will appear on the display.

If one of the “5CHR” modes is selected in step 4 above, press the [**F/W**] key to send another code group.

If one of the “REPT” modes is selected in step 4 above, press the [**F/W**] key to stop the CW generation.



8. Rotate the **DIAL** knob while pressing and holding the [**VOL**] key to adjust the CW sidetone output level.
9. Press and hold in the [**BANK**] key for one second to disable the CW Training feature and exit to normal operation.



1) The “CPM” selection is based on the international “PARIS” standard, which stipulates five characters per word.

2) You may adjust the CW sidetone pitch via Set Mode Item 20: CW PITCH.

Available selections are 400 - 1000 Hz (50 Hz/step).

PASSWORD

The **VR-160** provides a password feature which can minimize the chance that your transceiver could be used by an unauthorized party.

When the password feature is activated, the radio will ask for the four digit password to be entered when the radio is first turned on. You must enter the four digit password using the **DIAL** knob and **[V/M]** key (pressing the **[V/M]** key to select the password digit and rotating the **DIAL** knob to select the password in each digit). If the wrong password is entered, the microprocessor will shut down the radio automatically.



To enter the password and activating this feature, use the following procedure:

1. Press and hold in the **[BANK]** key for one second to enter the Set mode.
2. Rotate the **DIAL** knob to select Set Mode Item 38: PASSWORD.
Note: Do not forget to pull the **DIAL** knob to rotate the **DIAL** knob.
3. Press the **[BANK]** key briefly to enable adjustment of this Set Mode Item.
4. Press the **[V/M]** key briefly to blink the first digit of the password.
5. Rotate the **DIAL** knob to select the first digit of the desired number/letter (0 - 9, A, B, C, D, E, and F).
6. Press the **[V/M]** key to move to the next digit.
7. Repeat steps 5 and 6 to program the remaining numbers/letters of the desired password.
8. If you make a mistake, press the **[BAND]** key to move back to the previous digit, then re-select the correct number/letter.
9. When you have finished entering the password, press the **[V/M]** key and rotate the **DIAL** knob to select "ON" (to activate the password feature).
10. Press and hold in the **[BANK]** key for one second to save the new setting and exit to normal operation.

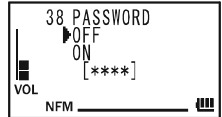
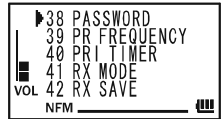

If you wish to disable the Password feature, repeat steps 1 - 3 above, then rotating the **DIAL** knob to select "OFF", then press and hold in the **[BANK]** key for one second.



- 1) *We recommend that you to write down the password, and keep it in a safe place where you can easily find if you forget your password.*
- 2) *If you forget your password, you may regain use of the transceiver by performing the "Microprocessor Resetting" procedure (see page 94). However, the VR-160 will clear the password, as well as all memories, and will restore all other settings to factory defaults.*

MISCELLANEOUS SETTING

ATT (FRONT END ATTENUATOR)

The attenuator will reduce all signals (and noise) by 10 dB, and it may be used to make reception more pleasant under extremely crowded conditions.

1. Press and hold in the **[BANK]** key for one second to enter the Set mode.
2. Rotate the **DIAL** knob to select Set Mode Item 04: ANTENNA ATT.
Note: Do not forget to pull the **DIAL** knob to rotate the **DIAL** knob.
3. Press the **[BANK]** key momentarily to enable adjustment of this Set Mode Item.
4. Rotate the **DIAL** knob to change the setting from “OFF” to “ON”.
5. When you have made your selection, press and hold in the **[BANK]** key for one second to save the new setting and exit to normal operation.
6. If you wish to disable the attenuator, just repeat the above procedure, rotating the **DIAL** knob to select “OFF” in step “4” above.



When the attenuator is activated, the “ATT” icon will appear on the display.



RECEIVE BATTERY SAVER SETUP

An important feature of the **VR-160** is its Receive Battery Saver, which “puts the radio to sleep” for a time interval, periodically “waking it up” to check for activity. If somebody is talking on the channel, the **VR-160** will remain in the “active” mode, then resume its “sleep” cycles when the signal drops. This feature significantly reduces quiescent channel battery drain. You may change the amount of “sleep” time between activity checks using the Set Mode:

1. Press and hold in the **[BANK]** key for one second to enter the Set mode.
2. Rotate the **DIAL** knob to select Set Mode Item 42: RX SAVE.
Note: Do not forget to pull the **DIAL** knob to rotate the **DIAL** knob.
3. Press the **[BANK]** key briefly to enable adjustment of this Set Mode Item.
4. Rotate the **DIAL** knob to select the desired “sleep” duration. The available selections are 200ms - 900ms (100 ms/step), 1 - 10.0sec (0.5 sec/step), or OFF. The default value is 200 ms.
5. When you have made your selection, press and hold in the **[BANK]** key for one second to save the new setting and exit to normal operation.



WAKEUP FEATURE

The Wakeup feature is similar to the Receive Battery Saver. However, it is a newer, more advanced feature which conserves battery life by providing a longer “sleep” time than the regular Receive battery Saver. The Wakeup feature, once engaged, operates while the transceiver is turned off (“WAKEUP” will appear on the LCD).

To set up the Wakeup feature:

1. Press and hold in the **[BANK]** key for one second to enter the Set mode.

2. Rotate the **DIAL** knob to select Set Mode Item 61: WAKE UP.

Note: Do not forget to pull the **DIAL** knob to rotate the **DIAL** knob.

3. Press the **[BANK]** key briefly to enable adjustment of this Set Mode Item.

4. Rotate the **DIAL** knob to select the desired “sleep” duration.

5 sec - 60 sec: (5 sec/steps) Based on the selected time value,

the radio will periodically check the operating

frequency which it was on when the radio was turned off for activity.

(That was in use when the radio was turned off.) If a signal is received on the frequency strong enough to open the Squelch, the radio will turn itself on fully.

OFF: Disables the Wakeup feature.

5. When you have made your selection, press and hold in the **[BANK]** key for one second to save the new setting and exit to normal operation.

If you wish to disable the Wakeup feature, just repeat the above procedure, rotating the **DIAL** knob to select “OFF” in step 4 above.

When the radio is turned off, the Wakeup feature will be engaged, and the “WAKEUP” notation will be seen on the display.

You may cancel the Wakeup feature (complete power off) temporarily by pressing the **POWER** switch while the Wakeup feature is engaged.

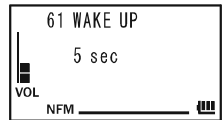

MISCELLANEOUS SETTING

DISABLING THE BUSY INDICATOR

Further battery conservation may be accomplished by disabling the **BUSY** indicator while receiving a signal. Use the following procedure:

1. Press and hold in the **[BANK]** key for one second to enter the Set mode.
2. Rotate the **DIAL** knob to select Set Mode Item 16: BSY LED.
Note: Do not forget to pull the **DIAL** knob to rotate the **DIAL** knob.
3. Press the **[BANK]** key briefly to enable adjustment of this Set Mode Item.
4. Rotate the **DIAL** knob to set this Set Mode Item to “OFF” (thus disabling the **BUSY** lamp).
5. When you have made your selection, press and hold in the **[BANK]** key for one second to save the new setting and exit to normal operation.



AUTOMATIC POWER-OFF (APO) FEATURE

The APO feature helps conserve battery life by automatically turning the radio off when there has been no dial or key activity for a user-defined period. The available selections for the time before power-off are 0.5 - 12 hours (0.5 hour/step), as well as APO Off. The default condition of the APO is OFF. This is the procedure to activate it:

1. Press and hold in the **[BANK]** key for one second to enter the Set mode.
2. Rotate the **DIAL** knob to select Set Mode Item 06: APO.
Note: Do not forget to pull the **DIAL** knob to rotate the **DIAL** knob.
3. Press the **[BANK]** key briefly to enable adjustment of this Set Mode Item.
4. Rotate the **DIAL** knob to select the desired time period after which the radio will automatically shut down.
5. When you have made your selection, press and hold in the **[BANK]** key for one second to save the new setting and exit to normal operation.

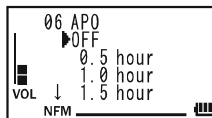
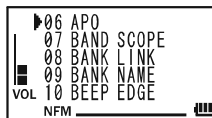

When the APO is activated, the “” icon will appear at the right bottom on the display. If there is no action by you within the time interval programmed, a ringer sounds 3 minutes before the APO shutdown time. Three minutes thereafter, the microprocessor will shut down the radio automatically.



Just press and hold in the **POWER** switch for one second to turn the radio back on after an APO shutdown, as usual.

AUTOMATIC POWER-ON FEATURE

The **VR-160** also includes the capability to turn itself on after a programmed time interval.

1. Press and hold in the **[BANK]** key for one second to enter the Set mode.

2. Rotate the **DIAL** knob to select Set Mode Item 36: ON TIMER.

Note: Do not forget to pull the **DIAL** knob to rotate the **DIAL** knob.

3. Press the **[BANK]** key briefly to enable adjustment of this Set Mode Item.

4. Rotate the **DIAL** knob to set the desired time after which the radio will automatically turn on. *Note:* that is not the time of day when the radio will turn on; it is the number of hours and minutes until the radio turns on. The available selections are 10 minutes - 24 hours (10 minute/step).

5. When you have made your selection, press and hold in the **[BANK]** key for one second to save the new setting and exit to normal operation.

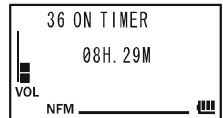
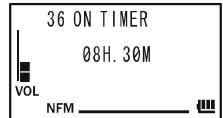
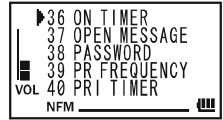

When the radio is turned off, this activates the Automatic Power-On feature; a countdown timer in the display will show the time remaining until automatic switch-on.

You may cancel the Automatic Power-On feature (turn off the radio), by pressing and holding the **POWER** switch for one second while the Automatic Power-On feature is engaged.

The Automatic Power-On feature will be ignored if the Wakeup feature is activated.

MISCELLANEOUS SETTING

MY BANDS OPERATION

The “My Bands” feature allows you to select several operating bands, and make only those bands available for selection via the [BAND] button.

For example, if you do not need the reception of the SW and Air bands, you may skip (omit) these bands from the band selection loop.

My Bands Setup

1. Set the **VR-160** to the VFO mode.
2. Press and hold in the [BANK] key for one second to enter the Set mode.
3. Rotate the **DIAL** knob to select Set Mode Item 59: VFO SKIP.

Note: Do not forget to pull the **DIAL** knob to rotate the **DIAL** knob.

4. Press the [BANK] key briefly to enable adjustment of this Item.
5. Rotate the **DIAL** knob to choose a operating band (see chart below) you wish to omit (skip) from the band selection loop.
6. Press the [F/W] key to append the “*” icon between the “operating number” and “operating name”; this will omit (skip) this band from the band selection loop.

Note: The band presently in use cannot be turned “ON” (the “-” icon is displayed between the “operating number” and “operating name”).

7. Repeat steps 4 through 6 above to select as many bands as you like.
8. When you have made your selection, press and hold in the [BANK] key for one second to save the new setting and return to normal operation.

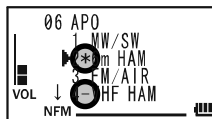
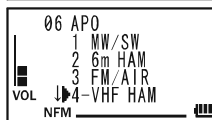

To re-institute a band into the band selection loop, repeat the above procedure, pressing the [F/W] key to delete the “*” icon in step 5.



If you wish to skip (omit) the AM or FM Broadcast band, enter the Broadcast Reception mode by pressing the [RADIO] key momentarily at first, then perform the above procedure.

OPERATING BAND [BAND NUMBER]	FREQUENCY RANGE
SW Band [1]	0.1 - 30 MHz
50 MHz Ham Band [2]	30 - 76 MHz
Air Band [3]	76 - 137 MHz
144 MHz Ham Band [4]	137 - 174 MHz
VHF-TV Band [5]	174 - 222 MHz
Information Band 1 [6]	222 - 420 MHz
430 MHz Ham Band [7]	420 - 470 MHz
UHF-TV Band [8]	470 - 800 MHz
Information Band 2 [9]	800 - 1000 MHz
1200 MHz Ham Band [a]	1000 - 1299.975 MHz

CLONING

The **VR-160** includes a convenient “Clone” feature, which allows the memory and configuration data from one transceiver to be transferred to another **VR-160**. This can be particularly useful when configuring a number of transceivers for a public service operation. Here is the procedure for Cloning one radio’s data to another:

1. Turn both radios off.
2. Connect the after-market 3.5-mm stereo cable between the **MIC/SP** jacks of the two radios.
3. Press and hold in the **[F/W]** key while turning the radios on. Do this for both radios (the order of switch-on does not matter). “CLONE” will appear on the displays of both radios when the Clone mode is successfully activated in this step.
4. On the Destination radio, press the **[V/M]** key (“- WAIT -” will appear on the LCD).
5. Press the **[BAND]** key on the Source radio; “- TX -” will appear on the Source radio, and the data from this radio will be transferred to the other radio.
6. If there is a problem during the cloning process, “ERROR” will be displayed. Check your cable connections and battery voltage, and try again.
7. If the data transfer is successful, the Destination radio returns to normal operation and “CLONE” will reappear on the Source radio.
8. Turn both radios off and disconnect the cloning cable. You can then turn the radios back on, and begin normal operation.

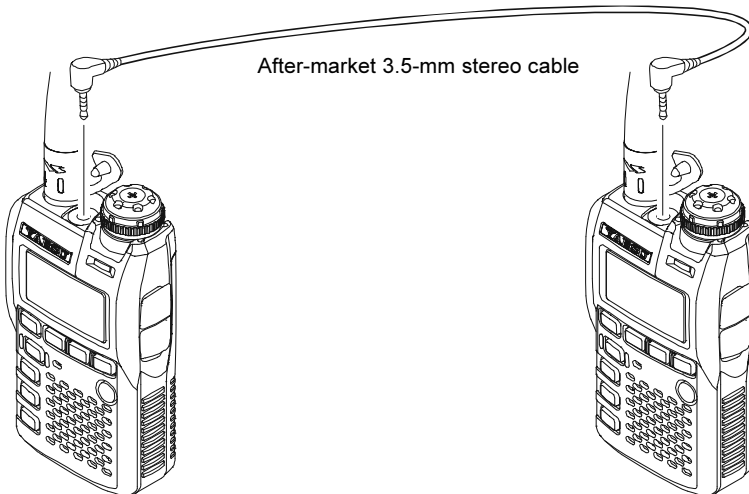
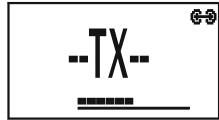

SET (MENU) MODE

The **VR-160** Set Mode, already partially discussed in many previous chapters, is easy to activate and set. The Set Mode is used to configure a wide variety of radio parameters, some of which have not been detailed previously. Use the following procedure to activate the Set Mode and adjust the various parameters:

1. Press and hold in the **[BANK]** key for one second to enter the Set mode.
2. Rotate the **DIAL** knob to select the Set Mode Item to be adjusted.
Note: Do not forget to pull the **DIAL** knob to rotate the **DIAL** knob.
3. Press the **[BANK]** key briefly to enable adjustment of the Set Mode Item.
4. Rotate the **DIAL** knob to adjust or select the parameter to be changed on the Set Mode Item selected in above step.
5. After completing your selection and adjustment, press and hold in the **[BANK]** key for one second to save the new setting and exit to normal operation.

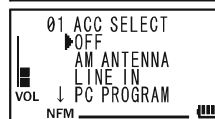
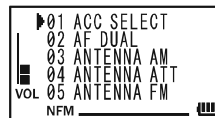

MASKING THE SET MODE ITEMS

There may be situations where you want to “Mask” Set Mode Items so they are not recalled during Set Mode Item selection.

1. Press and hold in the **[BANK]** key for one second to enter the Set mode.
2. Rotate the **DIAL** knob to select the Set Mode Item 25: EXTENDED MENU.
Note: Do not forget to pull the **DIAL** knob to rotate the **DIAL** knob.
3. Press the **[BANK]** key briefly to enable adjustment of the Set Mode Item.
4. Rotate the **DIAL** knob to select “ON”, then press the **[BANK]** key briefly.
5. Rotate the **DIAL** knob to select the Set Mode Item to be “Masked”.
6. Press the **[F/W]** key briefly. A small “*” icon will appear between the “Set Mode Item Number” and “Set Mode Item Name”, indicating the Set Mode Item is to be Masked.
7. Rotate the **DIAL** knob; the previously-selected Set Mode Item will be “Masked”.
8. Repeat steps 5 - 7 above, to append the “*” icon to any other Set Mode Item you wish to “Masked”.
9. Press and hold in the **[BANK]** key for one second to save the new setting and exit to normal operation.

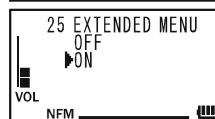
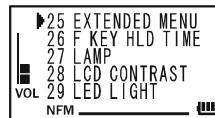

To unmask the hidden Set Mode Item, repeat the above procedure. In step 4 above select “OFF” and in step 6 above the “*” icon will disappear from the Set Mode Item you wish to unmask.

SET (MENU) MODE

SET MODE ITEM	FUNCTION	AVAILABLE VALUES (DEFAULT: BOLD ITALIC)
1 [ACC SELECT]	Select the Configuration of the ACC Jack.	OFF / AM ANTENNA / LINE IN / PC PROGRAM / S-METER
2 [AF DUAL]	Enables/Disables the AF DUAL function and sets the time before Broadcast audio is resumed after the desired frequency signal drops.	OFF / 1 sec - 10 sec (1 sec/step)
3 [ANTENNA AM]	Select the antenna to be used while listening in the AM Broadcast band.	BAR ANTENNA / BAR+EXT ANT
4 [ANTENNAATT]	Enables/Disables the receiver Front-end Attenuator.	OFF / ON
5 [ANTENNA FM]	Select the antenna to be used while listening in the FM Broadcast band.	EXT ANTENNA / EARPHONE ANT
6 [APO]	Setting of the Automatic Power-Off feature.	OFF / 0.5 hour - 12.0 hour (0.5 hour/steps)
7 [BAND SCOPE]	Selects the Band Scope sweep mode.	1time / CONTINUOUS
8 [BANK LINK]	Enables/Disables the Memory Bank Link Scan.	---
9 [BANK NAME]	Stores Alpha-Numeric "Tags" for the Memory Banks.	---
10 [BEEP EDGE]	Enables/Disables the Band-edge beeper while selecting the frequency using the DIAL knob.	OFF / ON
11 [BEEP LEVEL]	Adjust the Beep volume level.	LEVEL 1 - LEVEL 9 (LEVEL 5)
12 [BEEP MELODY]	Create the beep melody for Bell ringer function.	---
13 [BEEP SELECT]	Enables/Disables the Keypad beeper.	OFF / KEY+SCAN / KEY
14 [BELL RINGER]	Selects the number of Bell ringer repetitions.	1 time - 20 times / CONTINUOUS
15 [BELL SELECT]	Enables/Disables the Bell ringer function and its sound selection.	OFF / BELL / USER BEEP1 / USER BEEP2 / USER BEEP3
16 [BUSY LED]	Enables/Disables the BUSY LED while the Squelch is open.	OFF / ON
17 [CH COUNTER]	Selects the Channel Counter Search Width.	±5 MHz / ±10 MHz / ±50 MHz / ±100 MHz
18 [CLOCK SHIFT]	Shifting of the CPU clock frequency.	OFF / ON
19 [CW LEARNING]	Enables/Disables the CW Learning feature.	---
20 [CW PITCH]	Selects the CW tone pitch for the CW Learning and CW Training features.	400 - 1000 Hz (50 Hz/step) (700 Hz)
21 [CW TRAINING]	Enables/Disables the CW Training feature.	---
22 [DC VOLTAGE]	Indicates the DC Supply Voltage.	---
23 [DCS CODE]	Setting of the DCS code.	104 standard DCS codes
24 [DCS INVERSION]	Enables/Disables the "Inverted" DCS Tone.	NORMAL / REVERSE / BOTH
25 [EXTENDED MENU]	Enables/Disables the extended Set Mode Menu.	OFF / ON
26 [F KEY HOLD TIME]	Set the duration that a secondary function of the [F/W] key (press and holding the [F/W] key) is held determines the function they activate.	FW 0.3 sec / FW 0.5 sec / FW 0.7 sec / FW 1.0 sec / FW 1.5 sec
27 [LAMP]	Selects the LCD/Keypad Lamp mode.	KEY 2 sec - KEY 10 sec / CONTINUOUS / OFF (KEY 5 sec)
28 [LCD CONTRAST]	Setting of the Display contrast level.	LEVEL 1 - LEVEL 9 (LEVEL 5)
29 [LED LIGHT]	Illuminates the BUSY indicator.	---
30 [MR DISPLAY]	Toggles the display indication between "frequency" and "Alpha/Numeric" channel tags.	MAIN:FREQ / MAIN:ALPHA
31 [MR FAST STEP]	Selects the channel step for the fast channel selection mode while in the Memory Recall mode.	10 CH / 20 CH / 50 CH / 100 CH
32 [MRNAME]	Stores "Alpha-Numeric" tags for the Memory channels.	---
33 [MR PROTECT]	Enables/Disables the Memory Write Protector.	OFF / ON
34 [MR SKIP]	Selects the Memory Scan channel-selection mode.	OFF / SKIP / ONLY
35 [MR WRITE MODE]	Determines the method of selecting channels for Memory Storage.	LOWER / NEXT
36 [ON TIMER]	Set the On Timer Time.	OFF / 00H.10M (00:10) - 24H.00M (24:00) (10 minutes/step)
37 [OPEN MESSAGE]	Selects the Opening Message that appears when the radio is powered on.	OFF / DC / MESSAGE
38 [PASSWORD]	Programs and activates the Password feature.	---
39 [PR FREQUENCY]	Program the CTCSS Tone frequency for the User programmed Reverse CTCSS Decoder.	300Hz - 3000Hz (100 Hz/step) (1600Hz)
40 [PRI TIMER]	Selects the time between the Priority (Dual Watch) channel checks, when the feature is active.	100ms - 0.9ms (100 ms/step) or 1.0sec - 10.0sec (0.5 sec/step) (5.0sec)

SET (MENU) MODE

SET MODE ITEM	FUNCTION	AVAILABLE VALUES (DEFAULT: BOLD ITALIC)
41 [RX MODE]	Selects the Receiving mode.	N-FM / AM / W-FM / AUTO
42 [RX SAVE]	Selects the Receive-mode Battery Saver interval ("sleep" ratio)	200ms - 900ms (100 ms/step), 1.0sec - 10.0sec (0.5 sec/step), or OFF
43 [SCAN LAMP]	Enables/Disables the Scan lamp (while scanner is paused).	OFF / ON
44 [SCAN RE-START]	Select the Scan Re-start Delay time.	100ms - 900ms (100 ms/step) or 1.0sec - 10.0sec (0.5 sec/step) (2.0sec)
45 [SCAN RESUME]	Selects the Scan Resume mode.	2.0sec - 10.0sec / BUSY / HOLD (5.0sec)
46 [SMART SEARCH]	Selects the Smart Search Sweep mode.	SINGLE / CONTINUOUS
47 [S-METER SYMBOL]	Selects the S-meter symbol.	Three patterns
48 [SPEAKER OUT]	Enables/Disables the FM Broadcast audio output to the internal speaker when using the earphone antenna.	AUTO / SPEAKER
49 [SQL LEVEL]	Sets the Squelch threshold level.	LEVEL 0 - LEVEL 15 (LEVEL 1) (AM and Narrow FM), LEVEL 0 - LEVEL 8 (LEVEL 2) (Wide FM and AM Broadcast)
50 [SQL S-METER]	Adjusts the Squelch threshold to the S-meter level.	OFF / LEVEL 1 - LEVEL 8
51 [SQL TYPE]	Selects the Sub Audible Squelch Type.	OFF / TSQ / DCS / RVTN / PR FRQ
52 [STEP FREQUENCY]	Setting the Dial frequency steps.	AUTO / 5 / 8.33 / 9 / 10 / 12.5 / 15 / 20 / 25 / 50 / 100 kHz
53 [STEREO]	Enables/Disables the stereo output, while receiving the FM Broadcast band.	MONO / STEREO
54 [TEMPERATURE]	Indicates the current temperature inside the radio's case and selects the measurement units ("°F" or "°C") for the temperature sensor.	---
55 [TONE FREQUENCY]	Setting of the CTCSS Tone Frequency.	50 standard CTCSS tones (100.0 Hz)
56 [TONE-SCH MUTE]	Enables/Disables the receiver audio output while the Tone Search Scanner is activated.	OFF / ON
57 [TONE-SCH SPEED]	Selects the Tone Search Scanner speed.	FAST (2.5 tone/sec) / SLOW (1.25 tone/sec)
58 [VFO MODE]	Selects or disables the VFO band edge limiting for the current band.	ALL / BAND
59 [VFO SKIP]	Set the My Band.	---
60 [VOLUME MODE]	Select the [VOL] key function.	NORMAL / AUTOBACK
61 [WAKE UP]	Setting of the Wakeup feature.	OFF / 5 sec - 60 sec (5 sec/step)
62 [WX ALEAT]	Enables/Disables the NOAA Weather Alert Feature.	OFF / ON

SET (MENU) MODE

AM/FM BROADCAST SETTING

- Enables/Disables the AF DUAL function and sets the time before Broadcast audio is resumed after the desired frequency signal drops.
- Select the antenna to be used for the AM Broadcast band.
- Select the antenna to be used for the FM Broadcast band.
- Enables/Disables the FM Broadcast audio output to the internal speaker when using the earphone antenna.
- Enables/Disables the stereo output, while receiving the FM Broadcast band.

SET MODE ITEM

- 02 [AF DUAL]
- 03 [ANTENNA AM]
- 05 [ANTENNA FM]
- 48 [SPEAKER OUT]
- 53 [STEREO]

AVAILABLE VALUES (DEFAULT: **BOLD ITALIC**)

- OFF** / 1 sec - 10 sec (1 sec/step)
- BAR ANTENNA / **BAR+EXT ANT**
- EXT ANTENNA** / EARPHONE ANT
- AUTO** / SPEAKER
- MONO / **STEREO**

BATTERY SAVING SETTING

- Setting of the Automatic Power-Off feature.
- Enables/Disables the **BUSY LED** while the Squelch is open.
- Selects the Receive-mode Battery Saver interval ("sleep" ratio).
- Setting of the Wakeup feature.

SET MODE ITEM

- 06 [APO]
- 16 [BUSY LED]
- 42 [RX SAVE]
- 61 [WAKEUP]

AVAILABLE VALUES (DEFAULT: **BOLD ITALIC**)

- OFF** / 0.5 hour - 12.0 hour (0.5 hour/steps)
- OFF** / **ON**
- 200ms** - 900ms (100 ms/step), 1.0sec - 10.0sec (0.5 sec/step), or **OFF**
- OFF** / 5 sec - 60 sec (5 sec/step)

BEEP SETTING

- Enables/Disables the Band-edge beeper while selecting the frequency using the **DIAL** knob.
- Adjust the Beep volume level.
- Create the beep melody for Bell ringer function.
- Enables/Disables the Keypad beeper.
- Selects the number of Bell ringer repetitions.
- Enables/Disables the Bell ringer function and its sound selection.

SET MODE ITEM

- 10 [BEEP EDGE]
- 11 [BEEP LEVEL]
- 12 [BEEP MELODY]
- 13 [BEEP SELECT]
- 14 [BELL RINGER]
- 15 [BELL SELECT]

AVAILABLE VALUES (DEFAULT: **BOLD ITALIC**)

- OFF** / **ON**
- LEVEL 1 - LEVEL 9 (**LEVEL 5**)
-
- OFF** / **KEY+SCAN** / **KEY**
- 1 time** - 20 times / **CONTINUOUS**
- OFF** / **BELL** / **USER BEEP1** / **USER BEEP2** / **USER BEEP3**

CW LEARNING/TRAINING SETTING

- Enables/Disables the CW Learning feature.
- Selects the CW tone pitch for the CW Learning and CW Training features.
- Enables/Disables the CW Training feature.

SET MODE ITEM

- 19 [CW LEARNING]
- 20 [CW PITCH]
- 21 [CW TRAINING]

AVAILABLE VALUES (DEFAULT: **BOLD ITALIC**)

-
- 400 - 1000 Hz (50 Hz/step) (**700 Hz**)
-

TONE SQUELCH/DCS SETTING

- Setting of the DCS code.
- Enables/Disables the "Inverted" DCS Tone.
- Program the CTCSS Tone frequency for the User programmed Reverse CTCSS Decoder.
- Sets the Squelch threshold level.
- Adjusts the Squelch threshold to the S-meter level.
- Selects the Sub Audible Squelch Type.
- Setting of the CTCSS Tone Frequency.
- Enables/Disables the receiver audio output while the Tone Search Scanner is activated.
- Selects the Tone Search Scanner speed.

SET MODE ITEM

- 23 [DCS CODE]
- 24 [DCS INVERSION]
- 39 [PR FREQUENCY]
- 49 [SQL LEVEL]
- 50 [SQL S-METER]
- 51 [SQL TYPE]
- 55 [TONE FREQUENCY]
- 56 [TONE-SCH MUTE]
- 57 [TONE-SCH SPEED]

AVAILABLE VALUES (DEFAULT: **BOLD ITALIC**)

- 104 standard DCS codes
- NORMAL** / REVERSE / **BOTH**
- 300Hz - 3000Hz (1000 Hz/step) (**1600 Hz**)
- LEVEL 0 - LEVEL 15 (AM and Narrow FM), (**LEVEL 1**)
- LEVEL 0 - LEVEL 8 (Wide FM and AM Broadcast) (**LEVEL 2**)
- OFF** / LEVEL 1 - LEVEL 8
- OFF** / **TSQL** / **DCS** / **RVTN** / **PR FRQ**
- 50 standard CTCSS tones (**100.0Hz**)
- OFF** / **ON**
- FAST** (2.5 tone/sec) / **SLOW** (1.25 tone/sec)

SWITCHES/KNOB SETTING

- Set the duration that a secondary function of the [FW] key (press and holding the [FW] key) is held determines the function they activate.
- Select the [VOL] key function.

SET MODE ITEM

- 26 [F KEY HLD TIME]
- 60 [VOLUME MODE]

AVAILABLE VALUES (DEFAULT: **BOLD ITALIC**)

- FW 0.3 sec / **FW 0.5 sec** / FW 0.7 sec / FW 1.0 sec / FW 1.5 sec
- NORMAL** / **AUTOBACK**

SET (MENU) MODE

MEMORY SETTING	SET MODE ITEM	AVAILABLE VALUES (DEFAULT: <i>BOLD ITALIC</i>)
<input type="checkbox"/> Enables/Disables the Memory Bank Link Scan.	08 [BANK LINK]	---
<input type="checkbox"/> Stores Alpha-Numeric "Tags" for the Memory Banks.	09 [BANK NAME]	---
<input type="checkbox"/> Toggles the display indication between "frequency" and "Alpha/Numeric" channel tags.	30 [MR DISPLAY]	MAIN:FREQ / MAIN:ALPHA
<input type="checkbox"/> Selects the channel step for the fast channel selection mode while in the Memory Recall mode.	31 [MR FAST STEP]	10 CH / 20 CH / 50 CH / 100 CH
<input type="checkbox"/> Stores "Alpha-Numeric" tags for the Memory channels.	32 [MR NAME]	---
<input type="checkbox"/> Enables/Disables the Memory Write Protector.	33 [MR PROTECT]	OFF / ON
<input type="checkbox"/> Selects the Memory Scan channel-selection mode.	34 [MR SKIP]	OFF / SKIP / ONLY
<input type="checkbox"/> Determines the method of selecting channels for Memory Storage.	35 [MR WRITE MODE]	LOWER / NEXT
SCAN/SEARCH SETTING	SET MODE ITEM	AVAILABLE VALUES (DEFAULT: <i>BOLD ITALIC</i>)
<input type="checkbox"/> Selects the Band Scope sweep mode.	07 [BAND SCOPE]	1time / CONTINUOUS
<input type="checkbox"/> Selects the Channel Counter Search Width.	17 [CH COUNTER]	±5 MHz / ±10 MHz / ±50 MHz / ±100 MHz
<input type="checkbox"/> Selects the time between the Priority (Dual Watch) channel checks, when the feature is active.	40 [PRI TIMER]	100ms - 0.9ms (100 ms/step), 1.0sec - 10.0sec (0.5 sec/step) (5.0sec)
<input type="checkbox"/> Enables/Disables the Scan lamp (while scanner is paused).	43 [SCAN LAMP]	OFF / ON
<input type="checkbox"/> Select the Scan Re-start Delay time.	44 [SCAN RE-START]	100ms - 900ms (100 ms/step), 1.0sec - 10.0sec (0.5 sec/step) (2.0sec)
<input type="checkbox"/> Selects the Scan Resume mode.	45 [SCAN RESUME]	2.0sec - 10.0sec / BUSY / HOLD (5.0sec)
<input type="checkbox"/> Selects the Smart Search Sweep mode.	46 [SMART SEARCH]	SINGLE / CONTINUOUS
ILLUMINATION SETTING	SET MODE ITEM	AVAILABLE VALUES (DEFAULT: <i>BOLD ITALIC</i>)
<input type="checkbox"/> Selects the LCD/Keypad Lamp mode.	27 [LAMP]	KEY 2 sec - KEY 10 sec / CONTINUOUS / OFF (KEY 5 sec)
<input type="checkbox"/> Setting of the Display contrast level.	28 [LCD CONTRAST]	LEVEL 1 - LEVEL 9 (LEVEL 5)
<input type="checkbox"/> Illuminates the BUSY indicator.	29 [LED LIGHT]	---
DISPLAY SETTING	SET MODE ITEM	AVAILABLE VALUES (DEFAULT: <i>BOLD ITALIC</i>)
<input type="checkbox"/> Indicates the DC Supply Voltage.	22 [DC VOLTAGE]	---
<input type="checkbox"/> Selects the Opening Message that appears when the radio is powered on.	37 [OPNE MESSAGE]	OFF / DC / MESSAGE
<input type="checkbox"/> Programs and activates the Password feature.	38 [PASSWORD]	---
<input type="checkbox"/> Selects the S-meter symbol.	47 [S-METER SYMBOL]	Three patterns
<input type="checkbox"/> Indicates the current temperature inside the radio's case and selects the measurement units ("°F" or "°C") for the temperature sensor.	54 [TEMPERATURE]	---
<input type="checkbox"/> Set the My Band.	59 [VFO SKIP]	---
MISCELLANEOUS SETTING	SET MODE ITEM	AVAILABLE VALUES (DEFAULT: <i>BOLD ITALIC</i>)
<input type="checkbox"/> Select the ACC Jack function.	01 [ACC SELECT]	OFF / AM ANTENNA / LINE IN / PC PROGRAM / S-METER
<input type="checkbox"/> Enables/Disables the receiver Front-end Attenuator.	04 [ANTENNA ATT]	OFF / ON
<input type="checkbox"/> Shifting of the CPU clock frequency.	18 [CLOCK SHIFT]	OFF / ON
<input type="checkbox"/> Enables/Disables the extended Set Mode Menu.	25 [EXTENDED MENU]	OFF / ON
<input type="checkbox"/> Set the On Timer Time.	36 [ON TIMER]	OFF / 00H.10M (00:10) - 24H.00M (24:00) (10 minutes/step)
<input type="checkbox"/> Selects the Receiving mode.	41 [RX MODE]	N-FM / AM / W-FM / AUTO
<input type="checkbox"/> Setting the Dial frequency steps.	52 [STEP FREQUENCY]	AUTO / 5 / 8.33 / 9 / 10 / 12.5 / 15 / 20 / 25 / 50 / 100 kHz
<input type="checkbox"/> Selects or disables the VFO band edge limiting for the current band.	58 [VFO MODE]	ALL / BAND
<input type="checkbox"/> Enables/Disables the NOAA Weather Alert Feature.	62 [WX ALT]	OFF / ON

SET (MENU) MODE

Set Mode Item 01 [ACC SELECT]

Function: Selects the ACC Jack.

Available Values: OFF/AM ANTENNA/LINE IN/PC PROGRAM/S-METER

Default: OFF

Set Mode Item 02 [AF DUAL]

Function: Enables/Disables the AF DUAL function and sets the time before Broadcast audio is resumed after the desired band signal drops.

Available Values: OFF/1 sec - 10 sec (1 sec/step)

Default: OFF

OFF: Disables the AF DUAL function.

1 sec - 10 sec: Broadcast audio is resumed 1 to 10 seconds after the received signal drops.

Set Mode Item 03 [ANTENNA AM]

Function: Select the antenna to be used for the AM Broadcast band.

Available Values: BAR ANTENNA/BAR+EXT ANT

Default: BAR+EXT ANT

BAR ANTENNA: Uses the internal Bar Antenna only.

BAR+EXT ANT: Uses both the internal Bar Antenna and the Rubber Flex Antenna.

The Bar Antenna is directional; rotate the **VR-160** for best reception.

Set Mode Item 04 [ANTENNA ATT]

Function: Enables/Disables the receiver Front-end Attenuator.

Available Values: OFF/ON

Default: OFF

Note: This Set Mode Item can select and set the function to each memory channel individually.

Set Mode Item 05 [ANTENNA FM]

Function: Select the antenna to be used for the FM Broadcast band.

Available Values: EXT ANTENNA/EARPHONE ANT

Default: EXT ANTENNA

EXT ANTENNA: Uses the Rubber Flex Antenna.

EARPHONE ANT: Uses the Earphone Antenna. When receiving a weak signal, reception may be noisy.

Set Mode Item 06 [APO]

Function: Setting of the Automatic Power-Off feature.

Available Values: OFF/0.5 hour - 12.0 hour (0.5 hour/steps)

Default: OFF

Set Mode Item 07 [BAND SCOPE]

Function: Selects the Band Scope sweep mode.

Available Values: 1time/CONTINUOUS

Default: 1time

1time: The receiver sweeps the current band once.

CONTINUOUS: The receiver sweeps the current band repeatedly until the Band Scope is turned off.

Set Mode Item 08 [BANK LINK]

Function: Enables/Disables the Memory Bank Link Scan.

See page 45 for details.

Set Mode Item 09 [BANK NAME]

Function: Stores Alpha-Numeric “Tags” for the Memory Banks.

See page 37 for details.

Set Mode Item 10 [BEEP EDGE]

Function: Enables/Disables the Band-edge beeper while selecting the frequency using the DIAL knob.

Available Values: OFF/ON

Default: OFF

Set Mode Item 11 [BEEP LEVEL]

Function: Adjust the Beep volume level.

Available Values: LEVEL 1 - LEVEL 9

Default: LEVEL 5

Set Mode Item 12 [BEEP MELODY]

Function: Create the beep melody for Bell ringer function.

See page 28 for details.

Set Mode Item 13 [BEEP SELECT]

Function: Enables/Disables the Keypad beeper.

Available Values: OFF/KEY+SCAN/KEY

Default: KEY+SCAN

OFF: The Beeper is disabled.

KEY+SCAN: The beeper sounds when you press a key or when the scanner stops.

KEY: The beeper sounds when you press any key.

Set Mode Item 14 [BELL RINGER]

Function: Selects the number of Bell ringer repetitions.

Available Values: 1 time - 20 times/CONTINUOUS

Default: 1 time

SET (MENU) MODE

Set Mode Item 15 [BELL SELECT]

Function: Enables/Disables the Bell ringer function and its sound selection.

Available Values: OFF/BELL/USER BEEP1/USER BEEP2/USER BEEP3

Default: OFF

Note: This Set Mode Item can select and set the function to each memory channel individually.

Set Mode Item 16 [BUSY LED]

Function: Enables/Disables the **BUSY** LED while the Squelch is open.

Available Values: OFF/ON

Default: ON

Set Mode Item 17 [CH COUNTER]

Function: Selects the Channel Counter Search Width.

Available Values: ± 5 MHz/ ± 10 MHz/ ± 50 MHz/ ± 100 MHz

Default: ± 5 MHz

Set Mode Item 18 [CLOCK SHIFT]

Function: Shifting of the CPU clock frequency.

Available Values: OFF/ON

Default: OFF

Note: 1) This Set Mode Item can select and set the function to each memory channel individually.

2) This function is only used to move a spurious response “birdie”, should it fall on a desired frequency.

Set Mode Item 19 [CW LEARNING]

Function: Enables/Disables the CW Learning feature.

See page 60 for details.

Set Mode Item 20 [CW PITCH]

Function: Select the CW tone pitch for the CW Learning and CW Training features.

Available Values: 400 - 1000 Hz (50 Hz/step)

Default: 700 Hz

Set Mode Item 21 [CW TRAINING]

Function: Enables/Disables the CW Training feature.

See page 62 for details.

Set Mode Item 22 [DC VOLTAGE]

Function: Indicates the DC Supply Voltage.

Set Mode Item 23 [DCS CODE]

Function: Setting of the DCS code.

Available Values: 104 standard DCS codes

Default: DCS.023

Note: This Set Mode Item can select and set the function to each memory channel individually.

Set Mode Item 24 [DCS INVERSION]

Function: Enables/Disables the “Inverted” DCS Tone.

Available Values: NORMAL/REVERSE/BOTH

Default: NORMAL

NORMAL: Receive the Normal DCS Tone.

REVERSE: Receive the Inverted DCS Tone.

BOTH: Receive both Normal and Inverted DCS Tones.

Note: This Set Mode Item can select and set the function to each memory channel individually.

Set Mode Item 25 [EXTENDED MENU]

Function: Enables/Disables the extended Set Mode Menu.

Available Values: OFF/ON

Default: OFF

Set Mode Item 26 [F KEY HLD TIME]

Function: Set the duration that a secondary function of the [F/W] key (press and holding the [F/W] key) is held determines the function they activate.

Available Values: FW 0.3 sec/FW 0.5 sec/FW 0.7 sec/ FW 1.0 sec/FW 1.5 sec

Default: FW 0.5 sec

Set Mode Item 27 [LAMP]

Function: Selects the LCD/Keypad Lamp mode.

Available Values: KEY 2 sec - KEY 10 sec/CONTINUOUS/OFF

Default: KEY 5 sec (5 seconds)

KEY 2 sec - KEY 10 sec: Illuminates the LCD/Keypad for the selected time, when any key is pressed.

CONTINUOUS: Illuminates the LCD/Keypad continuously.

OFF: Disables the LCD/Keypad illumination.

SET (MENU) MODE

Set Mode Item 28 [LCD CONTRAST]

Function: Setting of the Display contrast level.

Available Values: LEVEL 1 - LEVEL 9

Default: LEVEL 5

Set Mode Item 29 [LED LIGHT]

Function: Illuminates the **BUSY** indicator. It will glow continuously white (useful as emergency flashlight at night).

Set Mode Item 30 [MR DISPLAY]

Function: Toggles the display indication between “frequency” and “Alpha/Numeric” channel tags.

Available Values: MAIN:FREQ/MAIN:ALPHA

Default: MAIN:FREQ

MAIN:FREQ: Indicates the large-sized channel frequency with the small-sized channel name.

MAIN:ALPHA: Indicates the large-sized channel name with the small-sized channel frequency.

Note: This Set Mode Item can select and set the function to each memory channel individually.

Set Mode Item 31 [MR FAST STEP]

Function: Selects the channel step for the fast channel selection mode while in the Memory Recall mode.

Available Values: 10 CH/20 CH/50 CH/100 CH

Default: 10 CH

Set Mode Item 32 [MR NAME]

Function: Stores “Alpha-Numeric” tags for the Memory channels.

See page 32 for details.

Note: This Set Mode Item can select and set the function to each memory channel individually.

Set Mode Item 33 [MR PROTECT]

Function: Enables/Disables the Memory Write Protector.

Available Values: OFF/ON

Default: OFF

When this function is set to “ON”, the memory write operation is ignored.

Set Mode Item 34 [MR SKIP]

Function: Selects the Memory Scan channel-selection mode.

Available Values: OFF/SKIP/ONLY

Default: OFF

OFF: All memory channels will be scanned (the “flag” will be ignored).

SKIP: The scanner will “skip” the flagged channels during scanning.

ONLY: The scanner will only scan channels that are flagged (Preferential Scan List).

Note: This Set Mode Item can select and set the function to each memory channel individually.

Set Mode Item 35 [MR WRITE MODE]

Function: Determines the method of selecting channels for Memory Storage.

Available Values: LOWER/NEXT

Default: NEXT

LOWER: Stores the data into the next-available “free” channel.

NEXT: Stores the data into the memory channel, which is next highest from the last-stored memory channel.

Set Mode Item 36 [ON TIMER]

Function: Set the On Timer Time.

Available Values: OFF/00H.10M (00:10) - 24H.00M (24:00) (10 minutes/step)

Default: OFF

The On Timer turns on the radio at the programmed time.

SET (MENU) MODE

Set Mode Item 37 [OPNE MESSAGE]

Function: Selects the Opening Message that appears when the radio is powered on.

Available Values: OFF/DC/MESSAGE

Default: DC

OFF: No Opening Message

DC: DC supply voltage

MESSAGE: Set by user. See below.

Here's how to program the Opening Message:

1. Rotate the **DIAL** knob to select this Set Mode Item to "MESSAGE".
2. Press the **[V/M]** key briefly to enable programming of the opening message. You will notice the first character entry's location blinking.
3. Rotate the **DIAL** knob to select the first letter/number of the message, then press the **[V/M]** key briefly to save the first letter/number and move on to the next character.
Note: Do not forget to pull the **DIAL** knob to rotate the **DIAL** knob
4. Repeat the steps 3 and 4 as necessary to complete the message (up to six characters).
5. If you make a mistake, press the **[BAND]** key to back-space the cursor; now re-enter the correct letter/number.
6. When you have entered the desired opening message, press the **[BANK]** key briefly to confirm the message, then press and hold in the **[BANK]** key for one second to save the settings and exit to normal operation.

Set Mode Item 38 [PASSWORD]

Function: Programs and activates the Password feature.

See page 61 for details.

Set Mode Item 39 [PR FREQUENCY]

Function: Program the CTCSS Tone frequency for the User programmed Reverse CTCSS Decoder.

Available Values: 300Hz - 3000Hz (100 Hz/step)

Default: 1600 Hz

Note: This Set Mode Item can select and set the function to each memory channel individually.

Set Mode Item 40 [PRI TIMER]

Function: Selects the time between the Priority (Dual Watch) channel checks, when the feature is active.

Available Values: 100ms - 0.9ms (100 ms/step) or 1.0sec - 10.0sec (0.5 sec/step)

Default: 5.0sec

See page 53 for details.

Set Mode Item 41 [RX MODE]

Function: Selects the Receiving mode.

Available Values: N-FM/AM/W-FM/AUTO

Default: AUTO (Mode automatically changes according to operating frequency.)

Note: This Set Mode Item can select and set the function to each memory channel individually.

Set Mode Item 42 [RX SAVE]

Function: Selects the Receive-mode Battery Saver interval (“sleep” ratio)

Available Values: 200ms - 900ms (100 ms/step), 1.0sec - 10.0sec (0.5 sec/step), or OFF

Default: 200 mS (1:1)

Set Mode Item 43 [SCAN LAMP]

Function: Enables/Disables the Scan lamp (while scanner is paused).

Available Values: OFF/ON

Default: ON

Set Mode Item 44 [SCAN RE-START]

Function: Select the Scan Re-start Delay time.

Available Values: 100ms - 900ms (100 ms/step), 1.0sec - 10.0sec (0.5 sec/step)

Default: 2.0sec

Set Mode Item 45 [SCAN RESUME]

Function: Selects the Scan Resume mode.

Available Values: 2.0sec - 10.0sec/BUSY/HOLD

Default: 5.0sec

2.0sec - 10.0sec: The scanner will halt on a signal it encounters, and will hold there for the selected resume time. If you do not take action to disable the scanner within that time period, the scanner will resume even if the station is still active.

BUSY: The scanner will halt on a signal it encounters. When the signal drops, the scanner will resume. The Scan resume time (default 2 seconds) is set by the Set Mode Item 44: SCAN RE-START.

HOLD: The scanner will halt on a signal it encounters. It will not restart automatically; you must manually re-initiate scanning if you wish to resume.

SET (MENU) MODE

Set Mode Item 46 [SMART SEARCH]

Function: Selects the Smart Search Sweep mode.

Available Values: SINGLE/CONTINUOUS

Default: SINGLE

SINGLE: The radio sweeps the current band once in each direction starting on the current frequency. All channels where activity is present (up to 15 in each direction) are loaded into the Smart Search memories. Whether or not all 31 memories are filled, the search stops after one sweep in each direction.

CONTINUOUS: The radio makes a sweep in each direction as with the “SINGLE” mode, but if all 31 channels are not filled after the first sweep, the radio continues sweeping until they are all filled.

Set Mode Item 47 [S-METER SYMBOL]

Function: Selects the S-meter symbol.

Available Values: Three patterns (, , or )

Default: 

Set Mode Item 48 [SPEAKER OUT]

Function: Enables/Disables the FM Broadcast audio output to the internal speaker when using the earphone antenna.

Available Values: AUTO/SPEAKER

Default: AUTO

AUTO: The FM Broadcast audio output is selected automatically depending on the connection of the earphone antenna.

SPEAKER: Outputs the FM Broadcast audio to the internal speaker only.

Set Mode Item 49 [SQL LEVEL]

Function: Sets the Squelch threshold level.

Available Values: LEVEL 0 - LEVEL 15 (AM and Narrow FM), LEVEL 0 - LEVEL 8 (Wide FM and AM Broadcast)

Default: LEVEL 1 (AM and Narrow FM), LEVEL 2 (Wide FM and AM Broadcast)

Set Mode Item 50 [SQL S-METER]

Function: Adjusts the Squelch threshold to the S-meter level.

Available Values: OFF/LEVEL 1 - LEVEL 8

Default: OFF

Note: This Set Mode Item can select and set the function to each memory channel individually.

Set Mode Item 51 [SQL TYPE]

Function: Selects the Sub Audible Squelch Type.

Available Values: OFF/TSQL/DCS/RVTN/PR FRQ

Default: OFF

TSQ: Activates the Tone Squelch

DCS: Activates the DCS

RV TN: Activates the Reverse Tone Squelch (Mutes the receiver when matching tone is received)

PR FRQ: Activates the User programmed Reverse Tone Squelch (Mutes the receiver when the matching tone programmed with Set Mode Item 39: PR FREQUENCY is received)

Note: This Set Mode Item can select and set the function to each memory channel individually.

Set Mode Item 52 [STEP FREQUENCY]

Function: Setting the Dial frequency steps.

Available Values: AUTO/5/8.33/9/10/12.5/15/20/25/50/100 kHz

Default: AUTO (Step automatically changes according to operating frequency.)

Note: 1) This Set Mode Item can select and set the Dial frequency steps to individual memory channels when Memory Offset Tuning is enabled as shown on page 36.

2) 9 kHz steps are available only when receiving on the AM Broadcast band.

3) 8.33 kHz steps are available only when receiving on the Air band.

4) While operating on the AM Broadcast band, you may only select channel steps of 9 kHz or 10 kHz; the other step selections are disabled.

5) 5 kHz steps are not available for use on 250 - 300 MHz, nor above 580 MHz.

Set Mode Item 53 [STEREO]

Function: Enables/Disables the stereo output, while receiving the FM Broadcast band.

Available Values: MONO/STEREO

Default: STEREO

Note: This Set Mode Item can select and set the function to each memory channel individually.

Set Mode Item 54 [TEMPERATURE]

Function: Indicates the current temperature inside the radio's case and selects the measurement units ("°F" or "°C") for the temperature sensor.

Press the [**MODE**] key to toggle the measurement units between "°F" and "°C".

SET (MENU) MODE

Set Mode Item 55 [TONE FREQUENCY]

Function: Setting of the CTCSS Tone Frequency.

Available Values: 50 standard CTCSS tones

Default: 100.0 Hz

Set Mode Item 56 [TONE-SCH MUTE]

Function: Enables/Disables the receiver audio output while the Tone Search Scanner is activated.

Available Values: OFF/ON

Default: ON

Set Mode Item 57 [TONE-SCH SPEED]

Function: Selects the Tone Search Scanner speed.

Available Values: FAST (2.5 tone/sec)/SLOW (1.25 tone/sec)

Default: FAST

Set Mode Item 58 [VFO MODE]

Function: Selects or disables the VFO band edge limiting for the current band.

Available Values: ALL/BAND

Default: BAND

BAND: When the VFO frequency reaches the high band edge of the current band, the VFO frequency will jump to the low band edge of the current band (or vice versa).

ALL: When the VFO frequency reaches the high edge of the current band, the VFO frequency will jump to the low band edge of the next band (or vice versa).

Set Mode Item 59 [VFO SKIP]

Function: Set the My Band.

See page 68 for details.

Set Mode Item 60 [VOLUME MODE]

Function: Select the [VOL] key function.

Available Values: NORMAL/AUTOBACK

Default: NORMAL

NORMAL: The [VOL] key keeps the status while pressing the [VOL] key.

AUTOBACK: The [VOL] key keeps the status approximately three seconds after pressing the [VOL] key.

Set Mode Item 61 [WAKEUP]

Function: Setting of the Wakeup feature.

Available Values: OFF/5 sec - 60 sec (5 sec/step)

Default: OFF

Set Mode Item 62 [WX ALT]

Function: Enables/Disables the NOAA Weather Alert Feature.

Available Values: OFF/ON

Default: OFF

EXTERNAL AM RADIO ANTENNA CONNECTIONS

The **VR-160** allows connecting an external antenna to an **ACC** Jack. Connecting a user constructed or aftermarket antenna may provide superior AM band sensitivity and reception.

1. Press and hold in the [**BANK**] key for one second to enter the Set mode.
2. Rotate the **DIAL** knob to select Set Mode Item 01: ACC SELECT.

Note: Do not forget to pull the **DIAL** knob to rotate the **DIAL** knob.

3. Press the [**BANK**] key briefly to enable adjustment of this Set Mode Item.
4. Rotate the **DIAL** knob to select “AM ANTENNA”.
5. Press the [**BANK**] key briefly to save the setting, then rotate the **DIAL** knob to select Set Mode Item 03: ANTENNA AM.
6. Press the [**BANK**] key briefly, then rotate the **DIAL** knob to select “BAR+EXT ANT”.
7. When you have made your selection, press and hold in the [**BANK**] key for one second to save the setting and exit to normal operation.

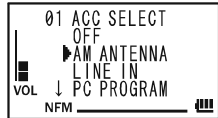
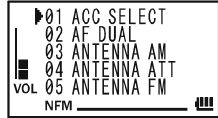

When the **ACC** Jack configuration is set to “AM ANTENNA”, the “**T-5**” icon will appear at the upper right corner of the display.

Refer to the illustration below, and connect the user constructed or an after-market antenna to the **ACC** Jack using the 3.5-mm stereo plug (not supplied).

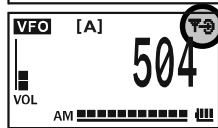

The antenna which connected to the ACC Jack works only in the AM Broadcast band (504 to 1791 kHz).

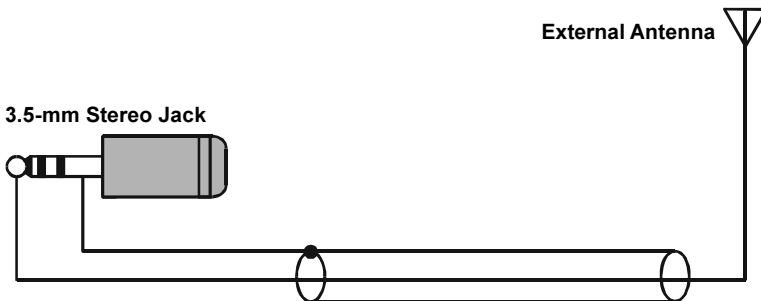

LINE-IN AUDIO CONNECTIONS

The **VR-160** allows connecting the audio signal from the external audio equipment such as an iPod® to an **ACC** Jack. If you engage the AF-DUAL function, you may monitor the amateur radio signal while listening to your favorite music, for example.

1. Press and hold in the **[BANK]** key for one second to enter the Set mode.
2. Rotate the **DIAL** knob to select Set Mode Item 01: ACC SELECT.

Note: Do not forget to pull the **DIAL** knob to rotate the **DIAL** knob.

3. Press the **[BANK]** key briefly to enable adjustment of this Set Mode Item.
4. Rotate the **DIAL** knob to select “LINE IN”.
5. When you have made your selection, press and hold in the **[BANK]** key for one second to save the setting and exit to normal operation.

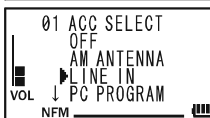
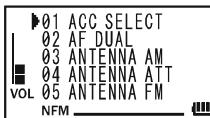

When the **ACC** Jack configuration is set to “LINE IN”, the “” icon will appear at the upper right corner of the display.



Refer to the illustration below, connect the external audio equipment to the **ACC** Jack using the after-market 3.5-mm to 3.5-mm stereo cable.

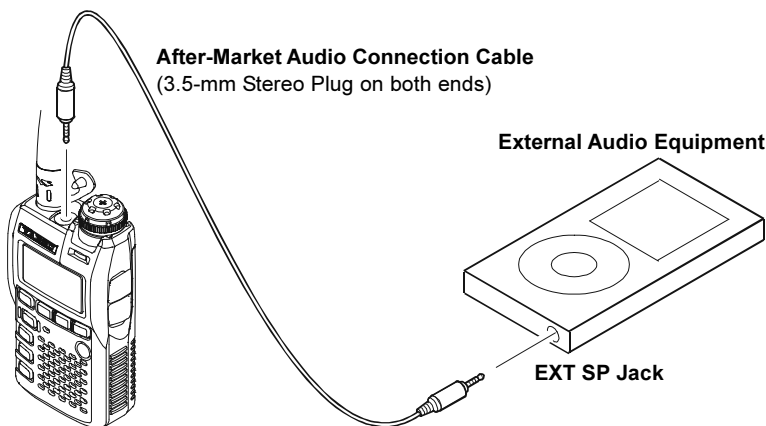

APPENDIX

COMPUTER CONNECTIONS

The **VR-160** allows connecting a computer USB port to the **ACC** Jack, and enables memory management and configuration using the Optional **ADMS-5** Advanced Data Management System.

1. Press and hold in the [**BANK**] key for one second to enter the Set mode.
2. Rotate the **DIAL** knob to select Set Mode Item 01: ACC SELECT.
Note: Do not forget to pull the **DIAL** knob to rotate the **DIAL** knob.
3. Press the [**BANK**] key briefly to enable adjustment of this Set Mode Item.
4. Rotate the **DIAL** knob to select "PC PROGRAM".
5. When you have made your selection, press and hold in the [**BANK**] key for one second to save the setting and exit to normal operation.

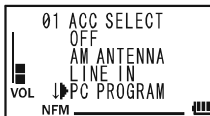
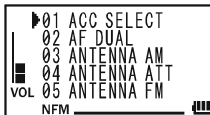

When the **ACC** Jack configuration is set to "PC PROGRAM", the "🔌" icon will appear at the upper right corner of the display.



Refer to the illustration below, connect the supplied Connection Cable of the **ADMS-5** between the **USB** jack of your Computer and the **ACC** Jack on the **VR-160**.

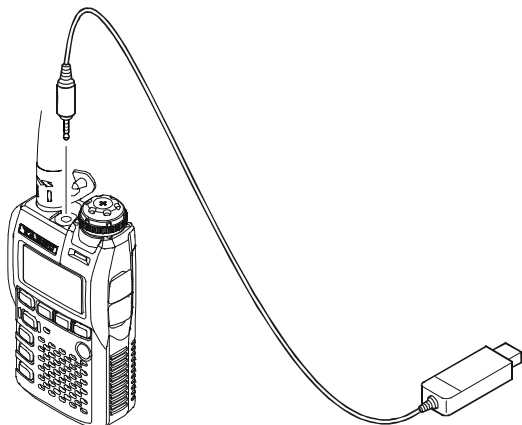



To Your Computer (USB Port)

S-METER CONNECTIONS

The **VR-160** allows connecting an analog S-meter to the **ACC** Jack.

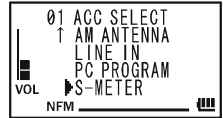
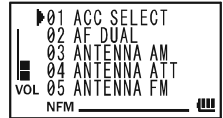
1. Press and hold in the **[BANK]** key for one second to enter the Set mode.
2. Rotate the **DIAL** knob to select Set Mode Item 01: ACC SELECT.
Note: Do not forget to pull the **DIAL** knob to rotate the **DIAL** knob.
3. Press the **[BANK]** key briefly to enable adjustment of this Set Mode Item.
4. Rotate the **DIAL** knob to select “S-METER”.
5. When you have made your selection, press and hold in the **[BANK]** key for one second to save the setting and exit to normal operation.



When the **ACC** Jack configuration is set to “S-METER”, the “” icon will appear at the upper right corner of the display. The “” icon deflects according to the receiving signal.

Refer to the illustration below, connect the after-market analog meter (sensitivity: $S1 = 0.3$ V, $S9 = 1.3$ V) to the **ACC** Jack. Adjust the external potentiometer (R) in your metering system so the external meter reading is same as the **VR-160** S-Meter reading.



The analog S-meter does not deflect on the AM and FM Broadcast band (504 - 1791 kHz and 76.00 - 107.90 MHz).

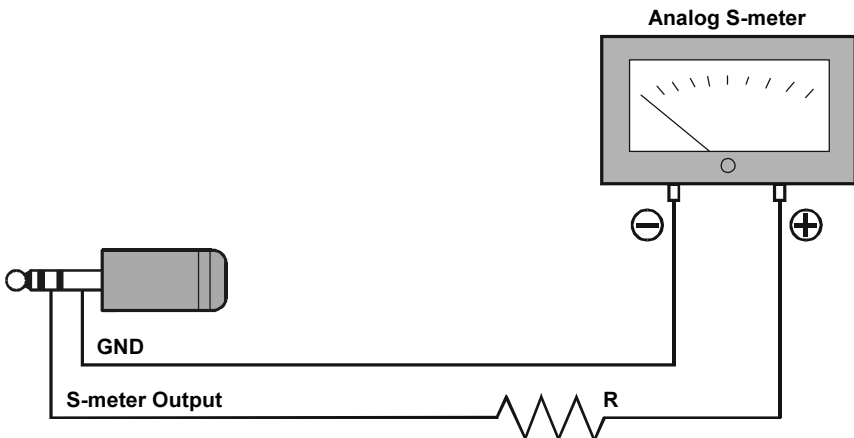

SPECIFICATIONS

Frequency Ranges:	Normal Band 0.1-1.8 MHz (BC Band) 1.8-30 MHz (SW Band) 30-76 MHz (50 MHz HAM) 76-108 MHz (FM Radio Band) 108-137 MHz (Air Band) 137-174 MHz (144 MHz HAM) 174-222 MHz (VHF TV) 222-420 MHz (GEN1) 420-470 MHz (430 MHz HAM) 470-800 MHz (UHF TV) 800-1000 MHz (GEN2) 1000-1299.975 MHz (1.2GHz HAM) Radio Band 0.504-1.795 MHz (AM Broadcast) 76-107.95 MHz (FM Broadcast)
Channel Steps:	5/8.33/9/10/12.5/15/20/25/50/100 kHz
Frequency Stability:	±5 ppm (−10 °C to +60 °C)
Antenna Impedance:	50 Ω
Supply Voltage:	Nominal: 3.7 V DC, FNB-82LI Battery Operation 6.0 V DC, PA-46C/U AC Adapter Operation Operating: 3.5-7.0 V, Negative Ground (EXT DC Jack)
Maximum Current:	800 mA (3.5-7 VDC)
Current Consumption:	140 mA (Receive, Normal Band, VOL level: 20) 100 mA (Receive, Radio Band, VOL level: 20) 58 mA (Standby, Saver Off) 20 mA (Standby, Saver On) 300 μA (Auto Power Off)
Operating Temp. Range:	−20 °C to +60 °C
Battery Charging Temp. Range:	+5 °C to +35 °C
Circuit Type:	AM, NFM: Double-Conversion Superheterodyne WFM: Triple-Conversion Superheterodyne AM Radio/FM Radio: Single-Conversion Superheterodyne
Intermediate Frequencies:	1st: 47.25 MHz (AM, NFM) 1st: 45.8 MHz (WFM) 1st: 130 kHz (AM Broadcast/FM Broadcast) 2nd: 450 kHz (AM, NFM) 2nd: 10.7 MHz (WFM) 3rd: 1 MHz (WFM)

Sensitivity:	1 μ V for 12 dB SINAD (0.5-0.5 MHz, NFM) 1 μ V for 10 dB SN (0.5-1.8 MHz, AM Radio) 1 μ V for 10 dB SN (1.8-30 MHz, AM) 0.35 μ V TYP for 12 dB SINAD (30-54 MHz, NFM) 0.5 μ V TYP for 12 dB SINAD (54-76 MHz, NFM) 1 μ V TYP for 12 dB SINAD (76-108 MHz, FM Radio) 0.5 μ V TYP for 10 dB SN (108-137 MHz, AM) 0.2 μ V for 12 dB SINAD (137-140 MHz, NFM) 0.16 μ V for 12 dB SINAD (140-150 MHz, NFM) 0.2 μ V for 12 dB SINAD (150-174 MHz, NFM) 1 μ V TYP for 12 dB SINAD (174-222 MHz, NFM) 0.5 μ V for 12 dB SINAD (300-350 MHz, NFM) 0.2 μ V for 12 dB SINAD (350-400 MHz, NFM) 0.18 μ V for 12 dB SINAD (400-470 MHz, NFM) 1 μ V for 12 dB SINAD (470-540 MHz, WFM) 1.5 μ V TYP for 12 dB SINAD (540-800 MHz, WFM) 0.5 μ V TYP for 12 dB SINAD (800-1000 MHz, NFM) 0.7 μ V TYP for 12 dB SINAD (1000-1300 MHz, NFM)
Selectivity:	NFM, AM: 12 kHz/35 kHz (-6 dB /-60 dB) WFM: 200 kHz / 300 kHz (-6 dB/-20 dB)
AF Output:	50 mW @ 8 Ω for 10 % THD (@ 4.5 V) 100 mW @ 8 Ω for 10 % THD (@ 6 V)
Case Size (W x H x D):	47 x 81 x 23 mm (w/FNB-82LI, w/o knob & antenna) 47 x 81 x 31 mm (w/FBA-37, w/o knob & antenna)
Weight:	130 g (w/FNB-82LI & antenna) 185 g (w/FBA-37 & antenna)

Specifications are subject to change without notice.

RESET PROCEDURES

In some instances of erratic or unpredictable operation, the cause may be corruption of data in the microprocessor (due to static electricity, etc.). If this happens, resetting of the microprocessor may restore normal operation. Note that all memories will be erased if you do a complete microprocessor reset, as described below.

1. Turn the radio off.
2. Press and hold in the [**MODE**] and [**V/M**] keys while turning the radio on.
3. Press the [**FW**] key momentarily to reset all settings to their factory defaults (press any other key to cancel the Reset procedure).

NOTE



Declaration of Conformity

We, Yaesu UK Ltd. declare under our sole responsibility that the following equipment complies with the essential requirements of the Directive 1999/5/EC.

Type of Equipment:	Communications Receiver
Brand Name:	YAESU
Model Number:	VR-160
Manufacturer:	Vertex Standard Co., Ltd.
Address of Manufacturer:	4-8-8 Nakameguro Meguro-Ku, Tokyo 153-8644, Japan

Applicable Standards:

This equipment is tested and conforms to the essential requirements of directive, as included in following standards.

EMC Standard:	EN 300 086-2 V1.2.1
	EN 301 489-1 V1.8.1
Safety Standard:	EN 60950-1 (2006)

The technical documentation as required by the Conformity Assessment procedures is kept at the following address:

Company: Yaesu UK Ltd.
Address: Unit 12, Sun Valley Business Park, Winnall Close
Winchester, Hampshire, SO23 0LB, U.K.

Disposal of your Electronic and Electric Equipment

Products with the symbol (crossed-out wheeled bin) cannot be disposed as household waste.

Electronic and Electric Equipment should be recycled at a facility capable of handling these items and their waste byproducts.

In EU countries, please contact your local equipment supplier representative or service center for information about the waste collection system in your country.





Copyright 2010
VERTEX STANDARD CO., LTD.
All rights reserved.

No portion of this manual
may be reproduced
without the permission of
VERTEX STANDARD CO., LTD.

Printed in Japan



E H 0 3 7 M 2 0 0