

MOTORCYCLES & PARTS 2021





 **YANNICK COQUARD**
CO-FOUNDER & FORMER
PROFESSIONAL RACER

NORMANDIE, FRANCE

DEPUIS 2004, YCF® DÉVELOPPE ET FABRIQUE DES MOTOS POUR LE GRAND PUBLIC, LE LOISIR ET LA COMPÉTITION. CHAQUE ANNÉE UNE NOUVELLE GAMME COMPLÈTE DE MOTOS FIABLES, ACCESSIBLES ET PERFORMANTES EST PROPOSÉE AFIN DE PROFITER PLEINEMENT DES JOIES DE LA MINI MOTO EN TOUTE SÉCURITÉ.

100% DES PRODUITS YCF SONT CONÇUS, DÉVELOPPÉS ET DESSINÉS EN INTERNE. GRACE AU DÉVELOPPEMENT EN COMPÉTITION, LES PRODUITS YCF BÉNÉFICIENT DES DERNIÈRES ÉVOLUTIONS DISPONIBLES POUR LE GRAND PUBLIC, POUR TOUTE LA FAMILLE.

BON RIDE À TOUS

NORMANDY, FRANCE

YCF® HAS BEEN DEVELOPING AND MANUFACTURING MOTORCYCLES FOR THE LAST 16 YEARS. BIKES MATCHED TO SKILL LEVELS FROM BEGINNERS TO ADVANCED. WHETHER YOU'RE PLAY RIDING OR COMPETING THERE'S A BIKE FOR YOU. EACH YEAR A NEW RANGE OF RELIABLE, AFFORDABLE AND HIGH-PERFORMANCE MOTORCYCLES ARE INTRODUCED. ALLOWING YOU TO EXPERIENCE ALL THE FUN THAT MINI BIKES HAVE TO OFFER. 100% OF YCF PRODUCTS ARE DEVISED, DESIGNED AND DEVELOPED IN-HOUSE. DUE TO BEING DEVELOPED UNDER COMPETITION CONDITIONS, YCF® TAKE'S ADVANTAGE OF THE VERY LATEST ADVANCES. THANK YOU FOR CHOOSING YCF®, HAVE A FUN RIDE!



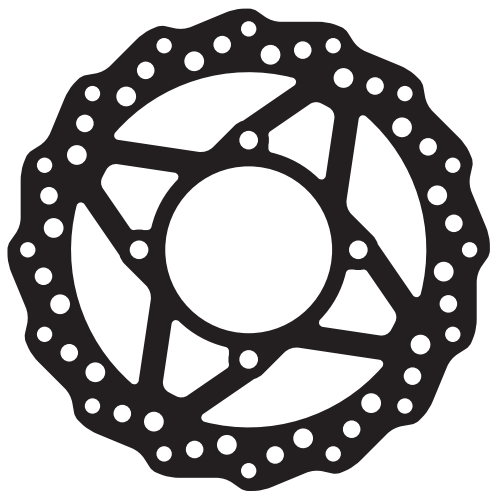

SPECIAL PARTS



FACTORY PARTS



FOR 50 ONLY



FOR SUPERMOTO



FOR BIGY® ONLY



ARRO® TIRES



DAYTONA® ENGINES



ENGI® FORK



MIKUNI® CARBURETORS



KEIHIN® CARBURETORS



TWINAIR® FILTERS



D'COR VISUALS® GRAPHICS



NIBBI CARBURETORS®



KENDA® TIRES



DNM® SUSPENSIONS



▶ GAMME 2021 RANGE 2021

YCF 50A	10
YCF 50E	12
LITE F88S	16
LITE F125	18
START F88SE	20
YCF W88	22
START F125	24
START F125SE	26
PILOT F125	28
PILOT F150	30
FACTORY SP2 F150	32
FACTORY SP3 F190	34
SM F125	36
SM F155	38
SM F190	40
BIGY 125 MX	42
BIGY 150 MX	44
BIGY 190 MX FACTORY ZE	46
BIGY 190 MX FACTORY DAYTONA®	48
PADDOCK/ PADDOCK	50
TEXTILES/ APPAREL	52

▶ ACCESSOIRES PLASTIQUES PLASTIC PARTS

KITS DÉCO/ GRAPHIC KITS	54
PERSONNALISATION/ CUSTOMIZATION	61
KITS PLASTIQUES/ PLASTIC KITS	62

▶ PIÈCES MOTO CYCLE PARTS

GUIDONS/ HANDLEBARS	72
POIGNÉES/ LEVERS	74
FOURCHES/ FORKS	76
CADRES/ FRAMES	79
SELLES/ SEATS	80
RÉSERVOIRS/ FUEL TANKS	81
FREINS/ BRAKES	82
BRAS OSCILLANTS/ SWING ARMS	90
AMORTISSEURS/ SHOCK ABSORBERS	92
ROUES/ WHEELS	93
JANTES & MOYEUX/ RIMS & HUBS	93
PNEUS/ TIRES	100
REPOSE-PIEDS & SABOTS/ FOOT PEGS & SKID PLATES	102
SÉLECTEURS/ SHIFT LEVERS	103
KITS CHAÎNES/ SPROCKET KITS	104
OUTILS/ TOOLS	106
ENGI®/ ENGI®	108

▶ PIÈCES MOTEUR ENGINE PARTS

MOTEURS DAYTONA®/ DAYTONA® ENGINES	112
MOTEURS/ ENGINES	113
KITS MOTEUR/ ENGINE KITS	114
EMBAYAGE/ CLUTCH	116
KITS DRESS UP/ DRESS UP KITS	118
CARBURATEURS/ CARBURETORS	120
FILTRES À AIR/ AIR FILTERS	122
ÉCHAPPEMENTS/ EXHAUSTS	123
FILTRES & RADIATEURS/ FILTERS & COOLERS	126
ALLUMAGE/ IGNITION	128
PIÈCES RACING DAYTONA®/ DAYTONA® RACING PARTS	130
PIÈCES D'ORIGINE DAYTONA®/ DAYTONA® PARTS	131

INDEX - FRENCH 2021

A

AIGUILLE DE CARBURATEUR.....	120
ALLUMAGE.....	128/130
AMORTISSEUR.....	92/109
ANTIPARASITE.....	129
ARBRE DE BOÎTE.....	115
ARRACHE VOLANT.....	106
ATTACHE RAPIDE DE CHAÎNE.....	104
ATTACHE SILENCIEUX.....	123/124
AXE DE BRAS OSCILLANT.....	91
AXE DE ROUE.....	97
AXE DE PLAQUETTE DE FREIN.....	82

B

BÂCHE MOTO.....	50
BAGUE D'AMORTISSEUR.....	92
BAGUE DE FOURCHE.....	76/108
BANDEROLE.....	50
BANNER.....	50
BARNUM.....	50
BARRE DE REPOSE-PIED.....	102
BATTERIE.....	128
BAVETTE D'AMORTISSEUR.....	92
BAVETTE AVEC PHARE.....	69
BÉQUILLE.....	51/79/92
BOBINE D'ALLUMAGE.....	128
BOÎTE À AIR.....	122
BONNET.....	52
BOUCHON DE RÉSERVOIR.....	81
BOUCHON DE VALVE.....	100
BOUCHON DE PURGE DE FOURCHE.....	76
BOUCHON DE VIDANGE.....	126
BOUCLE ARRIÈRE.....	79
BOUGIE.....	129
BRAS OSCILLANT.....	90
BRIDE DE POT.....	123

C

CÂBLE DE GAZ.....	75
CÂBLE D'EMBRAYAGE.....	75
CÂBLE DE PÉDALE DE FREIN.....	86
CACHE CDI.....	119
CACHE CULASSE.....	119/130
CACHE FILTRE À HUILE.....	118/130

CACHE POUSSIÈRE.....	108
CACHE SOUPAPES/ FILTRE À HUILE.....	118/119
CADRE.....	79
CAGE DE FILTRE À AIR.....	122
CALES PIEDS.....	102
CALE PLASTIQUE DE PIPE D'ADMISSION.....	121
CALE DE PONTET DE GUIDON 20 mm.....	77
CAOUTCHOUC D'EMBRAYAGE.....	75
CAOUTCHOUC DE LEVIER DE FREIN.....	75
CAOUTCHOUC D'ÉTRIER.....	85
CAPOT DE MAÎTRE-CYLINDRE FREIN.....	89
CARBURATEUR.....	120
CARTER D'ALLUMAGE.....	114
CARTER D'EMBRAYAGE.....	117
CASQUETTE.....	52
CDI.....	128
CERCEAU DE ROUE.....	96/97
CHAÎNE.....	104
CHAÎNE DE DÉMARREUR.....	114/130
CHAÎNE DE DISTRIBUTION.....	114/130
CHAISE PLIABLE.....	50
CHAMBRE À AIR.....	14/100
CHAPE DE MAÎTRE-CYLINDRE.....	86
CHARGEUR BATTERIE.....	128
CHEMISSETTE.....	52
CLOCHE D'EMBRAYAGE.....	116
COCOTTE D'EMBRAYAGE.....	75
COLLECTEUR.....	125
COMPTEUR D'HEURES.....	129
CONTACTEUR À CLÉ.....	129
COUPE CIRCUIT.....	129
COURONNE.....	104/105
COURONNE D'EMBRAYAGE.....	116
COUVERCLE DE FILTRE À AIR.....	122
COUVERCLE DE FILTRE À HUILE.....	118
COUVRES RAYONS.....	97
COUVRE RÉSERVOIR.....	81
CULASSE.....	115
CYLINDRE.....	115

D

DAYTONA® (PIÈCES).....	130-135
DÉRIVE CHAÎNE.....	106
DÉMONTE PNEU.....	106
DÉCO DE CADRE.....	55
DIABOLO CNC.....	90
DISQUE DE FREIN.....	88
DISQUE D'EMBRAYAGE.....	116
DONUTS.....	75
DURITE D'ESSENCE.....	81

DURITE DE FREIN.....	84/85
DURITE D'HUILE RADIATEUR.....	126

E

ÉCHAPPEMENT.....	123-125
ÉCHAPPEMENT COMPLET.....	124
ÉCROU DE BÉQUILLE.....	79
ÉCROU DE COLONNE DE DIRECTION.....	78
EMBOU DE PÉDALE DE FREIN.....	86
EMBOU DE POT.....	123/124
EMBOU DE MAÎTRE-CYLINDRE FREIN.....	86
EMBOU PLASTIQUE DE GUIDON.....	75
EMBRAYAGE COMPLET.....	116
ENGI® (PIÈCES).....	108/109
ENTRETOISE D'AMORTISSEUR.....	92
ENTRETOISE DE ROUE.....	98
ÉPURATEUR D'HUILE.....	126
ÉTRIER DE FREIN.....	82-85

F

FAISCEAUX ÉLECTRIQUES.....	128
FEUTRINE.....	50
FILTRE À AIR.....	122
FILTRE À HUILE.....	126
FOND DE JANTE.....	100
FOURCHE.....	76/108
FOURCHETTE DE BOÎTE.....	115
FREIN ARRIÈRE.....	82-85
FREIN AVANT.....	82-85
FREIN FILET.....	106

G

GARDE BOUE ARRIÈRE.....	65/66
GARDE BOUE AVANT.....	62/66/68
GICLEUR.....	120
GRIPSTER.....	97
GUIDE DE CHAÎNE.....	91
GUIDON.....	73

H

HUBLLOT À HUILE.....	126
----------------------	-----

J

JANTES.....	96/97
JAUGE À HUILE.....	126
JEU DE CALES MOTEUR.....	106
JEU DE RAYONS.....	97
JOINT DE BOUCHON DE RÉSERVOIR.....	81
JOINT DE CARTER D'EMBRAYAGE.....	117
JOINT DE COLONNE DE DIRECTION.....	78

JOINT DE CUVE POUR CARBURATEUR	120
JOINT PAPIER DE PIPE D'ADMISSION	121
JOINT DE POT	123
JOINT DE QUEUE DE SOUPAPE	115
JOINT SPY DE FOURCHE	108/76
JOINT SPY DE TIGE COMMANDE D'EMBRAYAGE	116
JOINT SPY DE KICK	116
JOINT SPY DE PSB	116
JOINT SPY DE ROUE	97
JOINT SPY DE SÉLECTEUR	116

K

KICK	103
KIT 212cc	130
KIT ARBRE À CAMES RACING	130
KIT DÉCO	54-59
KIT DÉCO DE CADRE	55
KIT DÉPART	108
KIT FREIN	82-85
KIT LAMPE	69
KIT PISTON	114/130
KIT PLASTIQUE	62-68
KIT RABAISSÉ	92
KIT RÉFECTION D'AMORTISSEUR	109
KIT RÉFECTION ENTRETOISE AXE AMORTISSEUR ...	109
KIT RÉFECTION DE FOURCHE	76
KIT RONDELLE CNC	69
KIT ROUE SUPERMOTARD	93
KIT ROULEMENT DE COLONNE DE DIRECTION	78
KIT STABILISATEUR	14
KIT SUPERMOTARD	103
KIT VIS	69/88

L

LAINÉ DE ROCHE	123
LEVIER D'EMBRAYAGE	74/75
LEVIER DE FREIN	74/75/82

M

MAÎTRE-CYLINDRE	82-85
MANCHON DE BOÎTE À AIR	122
MANCHON DE FILTRE À AIR	122
MANCHON DE PIPE D'ADMISSION	121
MOTEUR	112-113
MOUSSE DE GUIDON	72
MOYEU	98

N

NUMÉROS	61
---------------	----

O

ORIFLAMME	50
OUIE DE RADIATEUR	63/66
OUTILLAGE	106/108

P

PARAPLUIE	52
PASSE DURITE DE FREIN AVANT	69
PATTE DE CADRE	79
PATTE DE FREIN CNC	82
PATIN DE BRAS OSCILLANT	91
PATIN DE CHAÎNE	91
PÉDALE DE FREIN	86
PHARE	69
PIÈCES D'ORIGINE DAYTONA®	131
PIGNON	115/116
PIGNON DE CLOCHE D'EMBRAYAGE	116
PIGNON DE SORTIE DE BOÎTE	104
PIPE D'ADMISSION	121
PISTON	114/130
PLANCHE DE STICKERS	61
PLAQUE AVANT	62/67
PLAQUES LATÉRALES	64/67
PLAQUE PHARE	69
PLAQUETTES DE FREIN	88
PLATEAU D'ALLUMAGE	128
PLATINE RÉGLABLE AVEC REPOSE PIED	102
PNEU	100/101
POCHETTE DE JOINTS	115
POIGNÉE DE GAZ	74
POIGNÉES CAOUTCHOUC	75
POIGNÉES DE PLAQUES LATÉRALE	64/67
POINTEAU DE CARBURATEUR	120
PONTET DE GUIDON	77
PROTECTION DE FOURCHE	65
PROTECTION DE PIGNON SORTIE BOÎTE	105
PROTECTION SM	103
PROTÈGE DISQUE ARRIÈRE	91
PROTÈGE DISQUE AVANT	69
PROTÈGE LEVIER	72
PROTÈGE MAIN	72
PROTÈGE MAÎTRE-CYLINDRE	86

R

RAYONS	97
RADIATEUR D'HUILE	126
RÉGULATEUR DE TENSION	128
RELAIS DE DÉMARREUR	128
REPOSE PIED	102

RÉSERVOIR	81
RÉSERVOIR RÉCUPERATEUR HUILE/ ESSENCE	102
RESSORT D'AMORTISSEUR	92
RESSORT DE BÉQUILLE	79
RESSORT DE KICK	103
RESSORT DE PÉDALE DE FREIN	86
RESSORT DE POT	123/124
RESSORT POUR ÉTRIER RADIAL	82
ROBINET D'ESSENCE	81
ROUES	14/93-96
ROULEMENT DE COLONNE DE DIRECTION	78
ROULEMENT DE ROUE	97
ROULEMENT DE BRAS OSCILLANT	91
ROULETTE DE CHAÎNE	91
RUBALISE DE TERRAIN	50

S

SABOT	102
SEGMENT	114
SÉLECTEUR	103
SELLE	80
SILENCIEUX	123/124
SOUPAPE	115
STARTER AU GUIDON	121
SUPPORT DE COMPTEUR D'HEURES	129
SURFILTRE À AIR	122
SWEAT	52

T

TAPIS	51
TÉ DE FOURCHE	76/77
TEESHIRT	50
TENDEUR DE CHAÎNE	105
TIGE DE COMMANDE D'EMBRAYAGE	116
TONNELLE	50
TRÉPIED	51

V

VALVE PRISE AIR	81
VILEBREQUIN	114
VIS DE BÉQUILLE	79
VIS DE COURONNE	105
VIS DE CUVE	120
VIS DE DISQUE	88
VIS DE RALENTI	120
VIS ET ÉCROU TENDEUR DE CHAÎNE	91
VIS DE PLAQUETTE DE FREIN	88
VIS DE RÉGLAGE DE LA POIGNÉE DE GAZ	74
VIS RENFORCÉES POUR MOTEUR	79
VIS DE RICHESSE	120
VISSERIE	69/79/105

INDEX - ENGLISH 2021

A

AIR FILTERS.....	122
AIRBOX CAPS.....	122
AIRBOX RUBBER SLEEVES.....	122
AIRBOXES.....	122
APPAREL.....	52
AXLES.....	97

B

BANNER ROLL.....	50
BANNERS.....	50
BAR END CAPS.....	75
BAR MOUNTS.....	77
BATTERY CHARGER.....	128
BEANIE.....	52
BEARINGS.....	91/97
BIKE STANDS.....	51
BOLT KIT FOR AXLE BLOCK.....	91
BOLT KIT FOR BRAKE DISC.....	88
BOLT KITS FOR FUEL TANK.....	69
BOLT KIT FOR PLASTIC KIT.....	69
BOLT KIT FOR SEAT.....	69
BOLT KIT FOR SPROCKET.....	105
BRAKE CALIPERS.....	82-85
BRAKE CLEVIS.....	86
BRAKE DISCS.....	88
BRAKE GUARDS (FRONT).....	69
BRAKE HOSES.....	69
BRAKE LEVERS.....	74/75/83
BRAKE LEVER RUBBERS.....	75
BRAKE MASTER CYLINDERS.....	82-85
BRAKE PADS.....	88
BRAKE PEDALS.....	86
BRAKE RESERVOIR COVER.....	89
BRAKE SYSTEMS (COMPLETE).....	82-85

C

CAMSHAFT KIT.....	130
CAPS.....	52
CARBURETOR FLOAT.....	120
CARBURETORS.....	120
CDI.....	128
CDI COVER.....	119
CHAIN GUIDES.....	91

CHAIN LINKS.....	104
CHAIN SLIDERS.....	91
CHAIN TENSIONERS.....	91/105
CHAIN TOOLS.....	106
CHAINS.....	104
CHOKE LEVER.....	121
CLUTCH ASSEMBLY.....	116
CLUTCH BRACKET.....	75
CLUTCH CABLES.....	75
CLUTCH CONTROL OIL SEAL.....	116
CLUTCH COVER.....	117
CLUTCH FOR KICKSTARTER.....	116
CLUTCH LEVER RUBBERS.....	75
CLUTCH LEVERS.....	74/75
CLUTCH SPROCKET.....	115/116
CLUTCH TOOLS.....	106
COUNTERSHAFT SPROCKET.....	104
COUNTERSHAFT SPROCKET GUARD.....	105
COVER YX/LIFAN.....	118/119
CRANKSHAFTS.....	114
CUSTOM NUMBERS.....	61
CYLINDER HEAD COVER.....	119
CYLINDERS.....	115

D

DAYTONA ENGINE 212 KIT.....	130
DAYTONA® PARTS.....	130-135
DIGITAL TIRE PRESSURE GAUGE.....	106
DISCS.....	88
DISK GUARD.....	69/91
DUST SEALS.....	97

E

ENGI®.....	108/109
ENGINE ADJUSTMENT GAUGES.....	106
ENGINE BASH PLATE STEEL.....	102
ENGINE KITS.....	114/130
ENGINE REINFORCED BOLT SETS.....	79
ENGINES (COMPLETE).....	112/113
EXHAUSTS.....	123/124/126
EXHAUST END.....	123/124
EXHAUST PIPE.....	123/124
EXHAUST SEWER.....	126
EXHAUST SPRING.....	123/124
EXHAUST VALVE.....	115

F

FENDER.....	62/65/66/68
FILTER.....	122
FLAGS (PROMOTIONAL).....	50

FLYWHEEL REMOVER.....	106
FOAM AIR FILTER.....	122
FOLDABLE LEVERS.....	74
FOLDING CHAIR.....	50
FOOT PEG MOUNT BAR.....	102
FOOT PEGS.....	102
FORK AIR BLEEDER.....	76
FORK BUSHINGS ENGI®.....	108
FORK DRAIN PLUGS.....	126
FORK GUARDS.....	65
FORK OIL SEALS.....	76/108
FORK SEAL REPAIR KIT.....	76/108
FORKS.....	76/108
FORK TOOL.....	108
FRAMES.....	79
FUEL CAPS.....	81
FUEL HOSES.....	81
FUEL TANKS.....	81
FUEL TAPS.....	81
FUEL VENT PIPES.....	81

G

GASKET SETS.....	115/121
GEARBOX FORK (REINFORCED).....	115
GEARBOX SHAFT.....	115
GEARBOX SHAFT (COMPLETE MAIN).....	115
GEARBOX SHAFT (COMPLETE SECONDARY).....	115
GRAPHIC KITS.....	54-59
GRAPHICS FOR FRAME.....	55
GRIPS.....	75
GRIP DONUTS.....	75

H

HANDGUARDS.....	72
HANDLEBAR PADS.....	72
HANDLEBARS.....	73
HATS.....	52
HEAD LIGHTS.....	69
HEIGHT ADJUSTMENT KIT.....	92
HIGH TENSION IGNITION COIL.....	128
HOLESHOT DEVICE.....	108
HOODIE.....	52
HOUR METER.....	129
HUB SPACERS.....	98
HUBS.....	98

I

IDLE SCREW + SPRING.....	120
IGNITION COVER.....	114
IGNITION SWITCH.....	128

INLET PIPE	121
INLET VALVE	115
INTAKE GASKET	121
INTAKE MANIFOLD	121

K

KICKSTAND (ADJUSTABLE)	79
KICKSTAND SPRING	79
KICKSTARTER LEVER OIL SEAL	116
KICKSTARTER LEVERS	103
KICKSTARTER SPROCKET	116
KILL SWITCH	128

L

LIGHT	69
LIGHTED OIL PURIFIER	126
LEVER PROTECTION	72
LAUNCH CONTROL	108

M

MAGNETIC DRAIN PLUG	126
MAGNETO	128
MAIN JET	120
MOTORCYCLE COVER	50
MUD FLAP	92
MUDGUARDS	14/62/65/66/68
MUFFLER	123
MUFFLER CLAMPS	123/124
MUFFLER SPARK ARRESTOR	123

N

NEEDLE VALVE + SPRING	120
NIPPLE WRENCH	106
NUMBER PLATES	62/64/67
NUMBERS (CUSTOM)	61
NUT FOR STEERING STEM	78

O

OIL COOLER	126
OIL DIPSTICK	126
OIL DRAIN PLUG	126
OIL FILTER	126
OIL FILTER COVER	118
OIL LEVEL SIGHT GLASS	126
OIL SEAL	97
OIL SEAL ASSEMBLY TOOLS	108
OIL SEAL FOR COUNTERSHAFT SPROCKET	116
OIL STEEL LINE RETAINER	69
OVAL MUFFLER CLAMP	123

P

PISTON KITS	114/130
PISTON RING SETS	114
PIT TENT (3X3M)	50
PLASTIC KITS	62-68
PUSH ROD	116

R

REAR BRAKE LEVER TIPS	86
REAR SPOOL	90
REGULATOR	128
REMOTE SWITCH	129
RIM LOCKS	97
RIMS	96/97
RUBBER MANIFOLD SET	121
RUBBER MAT	51

S

SEAL FOR FUEL TANK CAP	81
SEAL FOR STEERING STEM	78
SEATS	80
SHAFT	115
SHIFT LEVERS	103
SHIRTS	52
SHOCK ABSORBERS	92/109
SHOCK ABSORBERS REPAIR KIT	109
SHOCK ABSORBERS SPACER KIT	109
SHOCK ABSORBERS SPRING	92
SIDE PLATES	64/67
SKID PLATE	102
SLEEVE FOR CARBURETOR	121
SLOW JET	120
SPACERS	92/98
SPACERS FOR BAR MOUNT	77
SPARK ARRESTOR	123
SPARK PLUG REMOVAL TOOL	106
SPARK PLUGS	129
SPOKE SKINS	97
SPOKE TOOL	106
SPOKES	97
SPROCKETS	104
SPROCKET GUARD	104
SPROCKET LOCKING TAB	104
STABILIZED WHEEL KIT	14
STAND SCREW & NUT	79
STANDARD LEVERS	75
STARTER CHAIN	114
STARTER RELAY	128
STICKER SHEET (YCF)	61

STREAMER	50
SUBFRAMES	79
SUPERMOTARD CATCH TANK KIT	103
SUPERMOTARD TEFLON PROTECTION SET	103
SUPPORTING PLATE FOR HOUR METER	128
SWING ARMS	90
SWING ARM SLIDER	91
SWITCH REMOTE CUT OFF (50CC)	128

T

TAIL LIGHT	69
TANK BOLT	120
TANK COVER	81
TANK SHROUDS	63/66
TANK RECUPERATOR OIL	102
TAPER ROLLER BEARINGS	78
THREADLOCK	106
THROTTLE ADJUSTING SCREW	74
THROTTLE ASSEMBLY	75
THROTTLE CABLES	75
THROTTLE HANDLE	74
TIMING SPROCKET	114/130
TIRES	100/101
TIRE LEVER	106
TIRE VALVE CAPS	100
TOOLS	106/108
TRACK TAPE	50
TRAINING WHEEL KIT	14
TRIPLE CLAMPS	76/77
T-SHIRTS	52
TUBES	14/100

U

UMBRELLA	52
----------------	----

V

VALVE ADJUSTMENT TOOL	106
VALVE COVERS	118
VALVE PLUG	100
VALVE STEM SEAL	115

W

WASHER FOR STEERING STEM NUT	78
WHEEL ASSEMBLY (COMPLETE)	14/93-96
WIRING HARNESS	128

Y

YCF PLASTIC HANDLES ON SIDE PLATES	64/67
--	-------



YCF 50A

YCF 50E

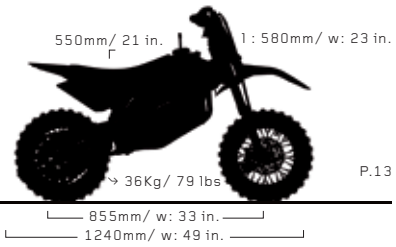
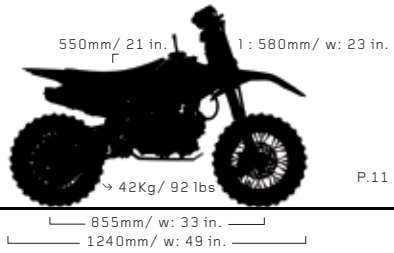

LITE F88S

LITE F125

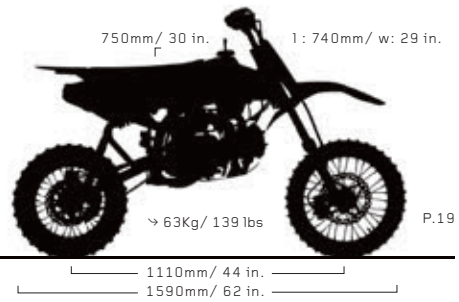
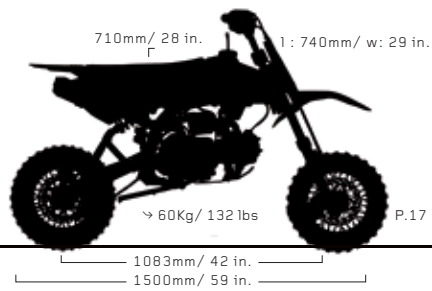

FACTORY SP2 150

FACTORY SP3 190

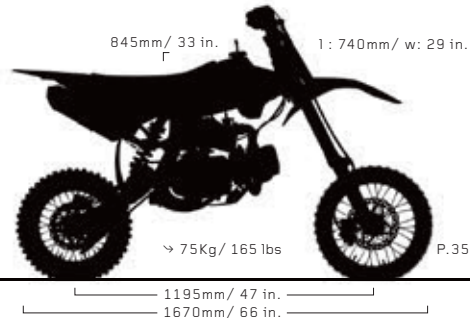
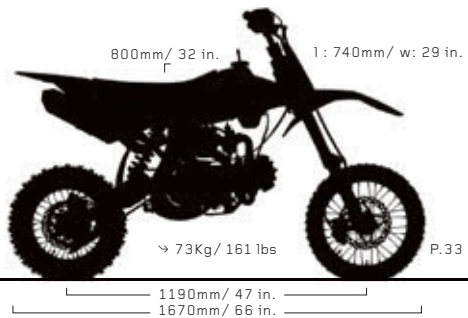

**CHOOSE
YOUR
WEAPON**

START

START F88SE

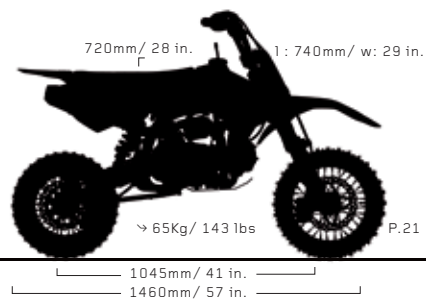

P.21

START F125
START F125SE

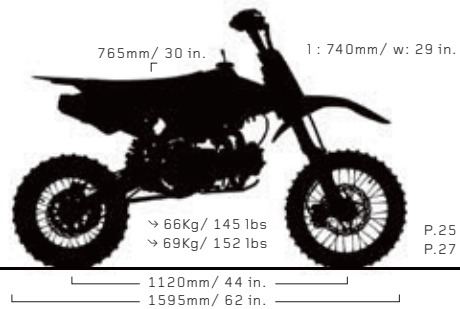

P.25
P.27

W88 ELECTRIC MOTOR

START W88

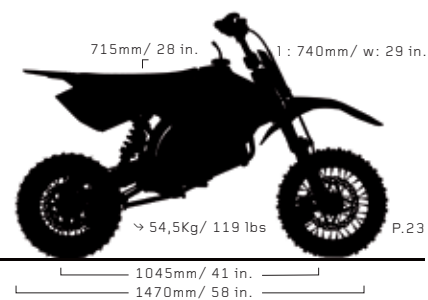

P.23

PILOT

PILOT F125

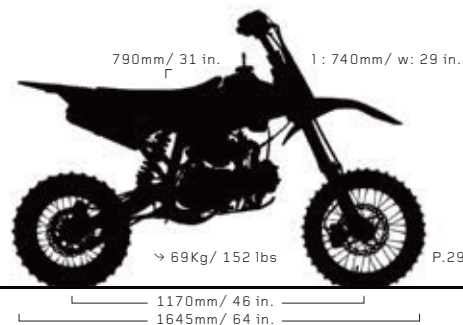

P.29

PILOT F150

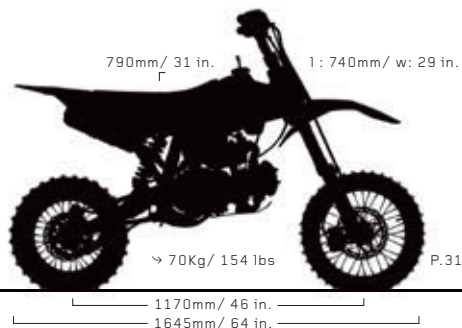

P.31

SM

SM F125

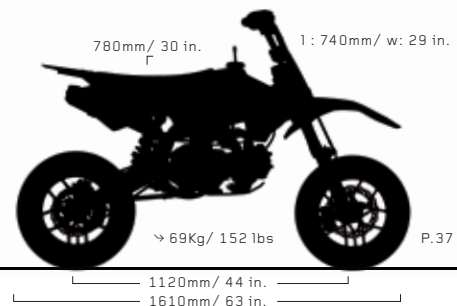

P.37

SM F155
SM F190

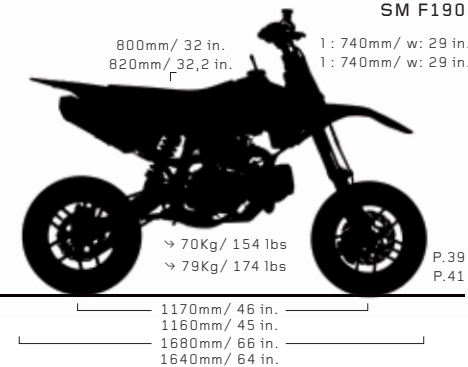

P.39
P.41

BIGY

BIGY 125 MX
BIGY 150 MX

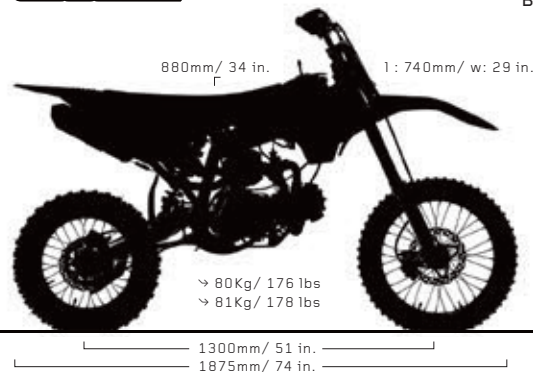

P.43
P.45

FACTORY

BIGY 190 MX FACTORY ZE
BIGY 190 MX FACTORY DAYTONA®



P.47
P.49



→ DISPONIBLE/ AVAILABLE PAGE 14

€ 1299

2021 YCF 50 A FUN FANATIC

SPÉCIFICATIONS

MOTEUR : MONO CYLINDRE REFROIDISSEMENT
À AIR / AUTOMATIQUE
FOURCHE INVERSÉE 530mm
SUSPENSION ARRIÈRE 200mm
PNEUS AV. & AR. : 2.50/10 - 2.50/10

SPECIFICATIONS

ENGINE TYPE: SINGLE CYLINDER AIR
COOLING/ AUTOMATIC GEAR BOX
530mm UPSD FORK
200mm REAR SUSPENSION
FRONT & REAR TIRES: 2.50/10 - 2.50/10

POINTS FORTS & NOUVEAUTÉS 2021

MOTEUR 4T 50CC
STARTER AU GUIDON
DÉMARREUR ÉLECTRIQUE
PRISE RAPIDE DE CHARGEUR DE BATTERIE
POIGNÉE GAZ RÉGLABLE
42 KGS SEULEMENT
CLÉ DE CONTACT ÉTANCHE
FREIN AVANT ET ARRIÈRE HYDRAULIQUE

HIGHLIGHTS & 2021 NEW FEATURES

50CC 4 STROKE ENGINE
START STRIGGER
ELECTRIC START
FAST BATTERY CHARGING
ADJUSTABLE THROTTLE
ONLY 92 LBS IN WEIGHT
WATERPROOF KEY CONTACTOR
HYDRAULIC BRAKE SYSTEM



YCF50A



550mm/ 21 in.

 42Kg/ 92 lbs

L : 580mm/ W: 23 in.

855mm/ 33 in.

1240mm/ 49 in.



→ DISPONIBLE / AVAILABLE PAGE 14

€ 1699

SPÉCIFICATIONS

MOTEUR : ÉLECTRIQUE 1200W
 BATTERIE LITHIUM 10aH
 FOURCHE INVERSÉE 530mm
 SUSPENSION ARRIÈRE 200mm
 PNEU AV. & ARR. : 2.50/10 - 2.50/ 10

SPECIFICATIONS

1200W ELECTRIC
 10 Ah LITHIUM BATTERY
 530mm UPSD FORK
 200mm REAR SUSPENSION
 FRONT & REAR TIRES: 2.50/10 - 2.50/ 10

2021 YCF 50 E
 SILENCE BUILT TO PERFECTION

POINTS FORTS & NOUVEAUTÉS 2021

MOTEUR ÉLECTRIQUE NÉODYMIUM MAGNET DC 1200W/ 48V
 BATTERIE LITHIUM/ TEMPS DE CHARGE 6H
 AUTONOMIE 1H30
 CHARGEUR LI-ION 110V/ 220V
 POIGNÉE GAZ INDICATEUR CHARGE BATTERIE
 36KG SEULEMENT
 RÉGLAGE DU TEMPS DE RÉPONSE À L'ACCÉLÉRATION
 FREIN AVANT ET ARRIÈRE HYDRAULIQUE

HIGHLIGHTS & 2021 NEW FEATURES

1200W/ 48V NEODYMIUM MAGNET DC ENGINE
 LITHIUM BATTERY/ CHARGING TIME 6 HOURS
 BATTERY LIFE 1H30
 LI-ION BATTERY CHARGER 110V/ 220V
 SPEED DIAL (POTENTIOMETER)
 THROTTLE WITH BATTERY CHARGE INDICATOR
 ONLY 79 LBS IN WEIGHT
 ACCELERATION RESPONSE TIME ADJUSTMENT
 HYDRAULIC BRAKE SYSTEM



YCF50E



550mm/ 21 in.

 **36Kg/ 79 lbs**

L : 580mm/ W: 23 in.

855mm/ 33 in.

1240mm/ 49 in.

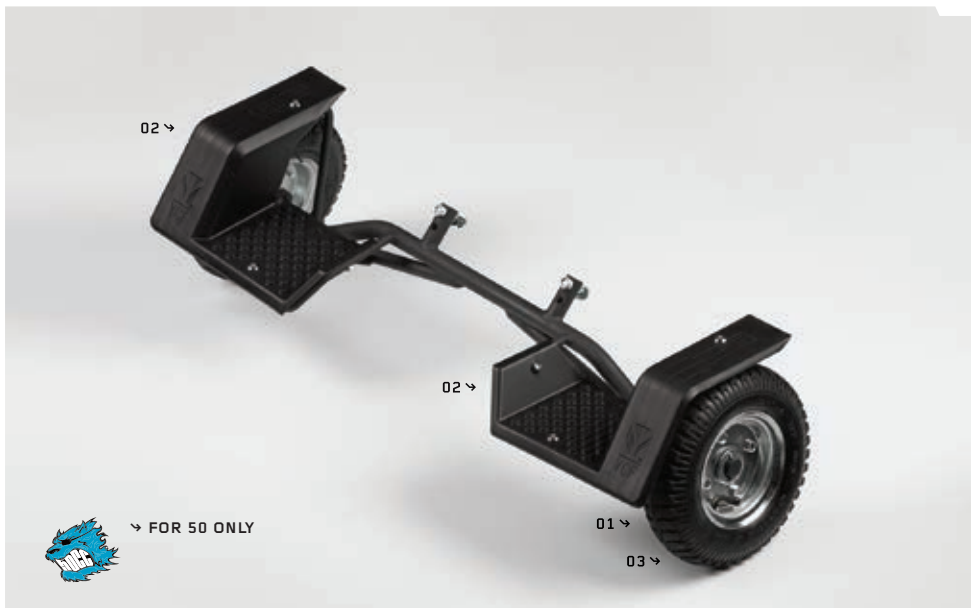

KIT STABILISATEUR POUR YCF 50
STABILIZER WHEEL KIT FOR YCF 50

→ YC50-2105

€ 119

CHAMBRE À AIR POUR KIT STABILISATEUR
TUBE FOR STABILIZER WHEEL KIT

03 → YC50-2106

€ 9

ROUE POUR KIT STABILISATEUR
WHEEL FOR STABILIZER WHEEL KIT

01 → YC50-2101

€ 19

GARDE BOUE POUR KIT STABILISATEUR
MUDGUARD FOR STABILIZER WHEEL KIT

02 → YC50-2103 (GAUCHE/ LEFT)
02 → YC50-2104 (DROIT/ RIGHT)

€ 25



PAGE 81 →

PAGE 75 →

PAGE 75 →

PAGE 100 →



PAGE 68 →

PAGE 81 →

PAGE 78 →

PAGE 129 →

PAGE 105 →

PAGE 81 →

PAGE 73 →



€ 1099

SPÉCIFICATIONS

MOTEUR: MONO CYLINDRE 4 TEMPS 88cc
 4 VITESSES EMBRAYAGE SEMI AUTOMATIQUE
 FOURCHE 600mm
 SUSPENSION ARRIÈRE 265mm
 PNEUS AV. & AR.: 250/12 - 300/10

SPECIFICATIONS

ENGINE TYPE: SINGLE CYLINDER 4 STROKES 88cc
 4 GEARS (N1234) WITH AUTOMATIC CLUTCH
 600mm FORK
 265mm REAR SUSPENSION
 FRONT & REAR TIRES: 250/12 - 300/10

2021 LITE F88S
 LIGHT? YOU BET!

POINTS FORTS & NOUVEAUTÉS 2021

POIGNÉE DE GAZ RÉGLABLE
 SEMI-AUTOMATIQUE
 SELLE BASSE COMPATIBLE PAGE 80
 FILTRE À AIR YCF
 POIGNÉE CAOUTCHOUC YCF
 SÉLECTEUR PLUS COURT
 KIT RABAISSÉ AMORTISSEUR PAGE 92
 TÉ FOURCHE CNC ET PONTET DE GUIDON 2 POSITIONS

HIGHLIGHTS & 2021 NEW FEATURES

ADJUSTABLE THROTTLE
 SEMI-AUTOMATIC
 COMPATIBLE LOW SEAT PAGE 80
 YCF AIR FILTER
 YCF GRIPS
 SHORTER GEARSHIFT
 HEIGHT ADJUSTMENT KIT PAGE 92
 CNC CLAMP WITH ADJUSTABLE BAR MOUNT

LITE

F885



710mm / 28 in.

 60Kg / 132 lbs

L : 740mm / W : 29 in.

1083mm / 42 in.

1500mm / 42 in.



€ 1099

SPÉCIFICATIONS

MOTEUR: MONO CYLINDRE 4 TEMPS 125cc
4 VITESSES EMBRAYAGE
FOURCHE 650mm
SUSPENSION ARRIÈRE 270mm
PNEUS AV. & AR.: 60/100/14 - 80/100/12

SPECIFICATIONS

ENGINE TYPE: SINGLE CYLINDER 4 STROKES 125cc
4 GEARS (N1234)
650mm FORK
270mm REAR SUSPENSION
FRONT & REAR TIRES: 60/100/14 - 80/100/12

2021 LITE F125 LIGHT? YOU BET!

POINTS FORTS & NOUVEAUTÉS 2021

POIGNÉE DE GAZ RÉGLABLE
EMBRAYAGE MANUEL
SELLE BASSE COMPATIBLE PAGE 80
FILTRE À AIR YCF
POIGNÉE CAOUTCHOUC YCF
SÉLECTEUR PLUS COURT
KIT RABAISSÉ AMORTISSEUR PAGE 92
TÉ FOURCHE CNC ET PONTET DE GUIDON 2 POSITIONS

HIGHLIGHTS & 2021 NEW FEATURES

ADJUSTABLE THROTTLE
MANUAL CLUTCH
COMPATIBLE LOW SEAT PAGE 80
YCF AIR FILTER
YCF GRIPS
SHORTER GEARSHIFT
HEIGHT ADJUSTMENT KIT PAGE 92
CNC CLAMP WITH ADJUSTABLE BAR MOUNT

LITE

F125

750mm / 30 in.



 63Kg / 139 lbs

L : 740mm / W : 29 in.

1110mm / 44 in.

1590mm / 62 in.



€ 1499

SPÉCIFICATIONS

MOTEUR: MONO CYLINDRE 4 TEMPS 88cc
4 VITESSES EMBRAYAGE SEMI AUTOMATIQUE
FOURCHE INVERSÉE 600mm
SUSPENSION ARRIÈRE RÉGLABLE 265mm
PNEUS AV. & AR.: 60/100/12 - 300/10

SPECIFICATIONS

ENGINE TYPE: SINGLE CYLINDER 4 STROKES 88cc
4 GEARS (N1234) WITH AUTOMATIC CLUTCH
600mm UPSD FORK
265mm ADJUSTABLE REAR SUSPENSION
FRONT & REAR TIRES: 60/100/12 - 300/10

**2021 START F88SE
MAGIC BUTTON**

POINTS FORTS & NOUVEAUTÉS 2021

DÉMARREUR ÉLECTRIQUE
SEMI-AUTOMATIQUE
POIGNÉE DE GAZ RÉGLABLE
BOUTON DE DÉMARREUR ÉTANCHE
SELLE BASSE COMPATIBLE PAGE 80
FILTRE À AIR YCF
POIGNÉE CAOUTCHOUC YCF
SÉLECTEUR PLUS COURT
TÉ FOURCHE CNC ET PONTET DE GUIDON 2 POSITIONS

HIGHLIGHTS & 2021 NEW FEATURES

ELECTRIC STARTER
SEMI-AUTOMATIC
ADJUSTABLE THROTTLE
WATERPROOF START BUTTON
COMPATIBLE LOW SEAT PAGE 80
YCF AIR FILTER
YCF GRIPS
SHORTER GEARSHIFT
CNC CLAMP WITH ADJUSTABLE BAR MOUNT

START

F885



720mm / 28 in.

 65Kg / 143 lbs

L : 740mm / W : 29 in.

1045mm / 41 in.

1460mm / 57 in.



€ 1999

SPÉCIFICATIONS

MOTEUR : ÉLECTRIQUE 1000W/ 60V
 BATTERIE LITHIUM 20Ah
 FOURCHE INVERSÉE 600mm
 SUSPENSION ARRIÈRE RÉGLABLE 265mm
 PNEUS AV. & AR. : 60/100/12 - 300/10

SPECIFICATIONS

ENGINE TYPE: 1000W/ 60V ELECTRIC
 20Ah LITHIUM BATTERY
 600mm UPSD FORK
 265mm ADJUSTABLE REAR SUSPENSION
 FRONT & REAR TIRES: 60/100/12 - 300/10

2021 START W88
 THE NEW ERA OF ELECTRIC

POINTS FORTS & NOUVEAUTÉS 2021

MOTEUR BRUSHLESS 1000W/ 60V
 BATTERIE LITHIUM/ TEMPS DE CHARGE 7H
 AUTOMIE 1H00
 CHARGEUR LI-ION 110V/ 220V
 POIGNÉE DE GAZ AVEC INDICATEUR DE CHARGE DE BATTERIE
 RÉGLAGE PARENTAL (POTENTIOMETRE)
 54,5 KG SEULEMENT
 PROTECTION DE CHAÎNE
 PROTECTION MOTEUR/ BATTERIE PAR CAISSON FIBRE DE VERRE
 RÉGLAGE DU TEMPS DE RÉPONSE À L'ACCELERATION
 SELLE BASSE COMPATIBLE PAGE 80
 KIT RABAISSÉ ADAPTABLE PAGE 92

HIGHLIGHTS & 2021 NEW FEATURES

1000W/ 60V BRUSHLESS ENGINE (BDLC)
 LITHIUM BATTERY/ CHARGING TIME 7 HOURS
 BATTERY LIFE 1:00
 LI-ION BATTERY CHARGER 110V/ 220V
 THROTTLE WITH BATTERY CHARGE INDICATOR
 SPEED DIAL (POTENTIOMETER)
 ONLY 119 LBS IN WEIGHT
 FULL COVERAGE CHAIN GUARD
 FIBER GLASS FULL COVERAGE OF THE ENGINE
 ACCELERATION RESPONSE TIME ADJUSTMENT
 COMPATIBLE LOW SEAT PAGE 80
 HEIGHT ADJUSTMENT KIT PAGE 92

START

88 ELECTRIC MOTOR



715mm / 28 in.

 54,5Kg / 119 lbs

L : 740mm / W : 29 in.

1045mm / 41 in.

1470mm / 58 in.



€ 1399

SPÉCIFICATIONS

MOTEUR: MONO CYLINDRE 4 TEMPS 125cc
4 VITESSES EMBRAYAGE
FOURCHE INVERSÉE 660mm
SUSPENSION ARRIÈRE RÉGLABLE 270mm
PNEUS AV. & AR.: 60/100/14 - 80/100/12

SPECIFICATIONS

ENGINE TYPE: SINGLE CYLINDER 4 STROKES 125cc
4 GEARS (N1234)
660mm UPSD FORK
270mm ADJUSTABLE REAR SUSPENSION
FRONT & REAR TIRES: 60/100/14 - 80/100/12

2021 START F125 FAST & EASY

POINTS FORTS & NOUVEAUTÉS 2021

POIGNÉE DE GAZ RÉGLABLE
JOINT ÉTANCHE DE COLONNE DE DIRECTION
SELLE BASSE COMPATIBLE PAGE 80
KIT RABAISSÉ ADAPTABLE PAGE 92
FILTRE À AIR YCF
POIGNÉE CAOUTCHOUC YCF
SÉLECTEUR PLUS COURT
TÉ FOURCHE CNC ET PONTET DE GUIDON 2 POSITIONS

HIGHLIGHTS & 2021 NEW FEATURES

ADJUSTABLE THROTTLE
SEALING WASHER FOR STEERING STEM
COMPATIBLE LOW SEAT PAGE 80
HEIGHT ADJUSTMENT KIT PAGE 92
YCF AIR FILTER
YCF GRIPS
SHORTER GEARSHIFT
CNC CLAMP WITH ADJUSTABLE BAR MOUNT

START

F125

765mm/ 30 in.



 66Kg/ 145 lbs

L : 740mm/ W : 29 in.

1120mm/ 44 in.

1595mm/ 62 in.



€ 1549

SPÉCIFICATIONS

MOTEUR: MONO CYLINDRE 4 TEMPS 125cc
4 VITESSES EMBRAYAGE SEMI AUTOMATIQUE
FOURCHE INVERSÉE 660mm
SUSPENSION ARRIÈRE RÉGLABLE 270mm
PNEUS AV. & AR.: 60/100/14 - 80/100/12

SPECIFICATIONS

ENGINE TYPE: SINGLE CYLINDER 4 STROKES 125cc
4 GEARS (N1234) WITH AUTOMATIC CLUTCH
660mm UPSD FORK
270mm ADJUSTABLE REAR SUSPENSION
FRONT & REAR TIRES: 60/100/14 - 80/100/12

2021 START F125SE THE ULTIMATE BATTLE MACHINE

POINTS FORTS & NOUVEAUTÉS 2021

DÉMARREUR ÉLECTRIQUE
SEMI-AUTOMATIQUE
POIGNÉE DE GAZ RÉGLABLE
SELLE BASSE COMPATIBLE PAGE 80
FILTRE À AIR YCF
POIGNÉE CAOUTCHOUC YCF
SÉLECTEUR PLUS COURT
TÉ FOURCHE CNC ET PONTET DE GUIDON 2 POSITIONS

HIGHLIGHTS & 2021 NEW FEATURES

ELECTRIC START
SEMI-AUTOMATIC
ADJUSTABLE THROTTLE
COMPATIBLE LOW SEAT PAGE 80
YCF AIR FILTER
YCF GRIPS
SHORTER GEARSHIFT
CNC CLAMP WITH ADJUSTABLE BAR MOUNT

START

F125S

765mm / 30 in.



 **69Kg / 152 lbs**

L : 740mm / W : 29 in.

1120mm / 44 in.

1595mm / 62 in.



€ 1549

SPÉCIFICATIONS

MOTEUR: MONO CYLINDRE
4 TEMPS 125cc/ 4 VITESSES
FOURCHE INVERSÉE 735mm
SUSPENSION ARRIÈRE RÉGLABLE 330mm
PNEUS AV. & AR.: 60/100/14 - 80/100/12

SPECIFICATIONS

ENGINE TYPE: SINGLE CYLINDER
4 STROKES 125cc/ 4 GEARS (N1234)
FORK: 735mm UPSD FORK
REAR SUSPENSION: 330mm ADJUSTABLE
FRONT & REAR TIRES: 60/100/14 - 80/100/12

2021 PILOT F125 WORLD CLASS SIZE

POINTS FORTS & NOUVEAUTÉS 2021

POIGNÉE DE GAZ RÉGLABLE
BOÎTE À AIR
POIGNÉE CAOUTCHOUC YCF
SÉLECTEUR PLUS COURT
TÉ FOURCHE CNC ET PONTET DE GUIDON 2 POSITIONS

HIGHLIGHTS & 2021 NEW FEATURES

ADJUSTABLE THROTTLE
AIR BOX
YCF GRIPS
SHORTER GEARSHIFT
CNC CLAMP WITH ADJUSTABLE BAR MOUNT

PILOT

F125



790mm/ 31 in.

 69Kg/ 152 lbs

L : 740mm/ W: 29 in.

1170mm/ 46 in.

1645mm/ 64 in.



€ 1749

SPÉCIFICATIONS

MOTEUR: MONOCYLINDRE 4 TEMPS
150cc/ 4 VITESSES (N1234)
FOURCHE INVERSÉE 735mm
SUSPENSION ARRIÈRE RÉGLABLE 330mm
PNEUS AV. & AR.: 60/100/14 - 80/100/12

SPECIFICATIONS

ENGINE TYPE: SINGLE CYLINDER 4 STROKES
150cc/ 4 GEARS (N1234)
735mm UPSD FORK
330mm ADJUSTABLE REAR SUSPENSION
FRONT & REAR TIRES: 60/100/14 - 80/100/12

2021 PILOT F150 THE ULTIMATE 150

POINTS FORTS & NOUVEAUTÉS 2021

BOÎTE À AIR
POIGNÉE CAOUTCHOUC YCF
SÉLECTEUR PLUS COURT
TÉ FOURCHE CNC ET PONTET DE GUIDON 2 POSITIONS

HIGHLIGHTS & 2021 NEW FEATURES

AIR BOX
YCF GRIPS
SHORTER GEARSHIFT
CNC CLAMP WITH ADJUSTABLE BAR MOUNT

PILOT

F150

790mm / 31 in.



 65Kg / 154 lbs

L : 740mm / W : 29 in.

1170mm / 46 in.

1645mm / 64 in.

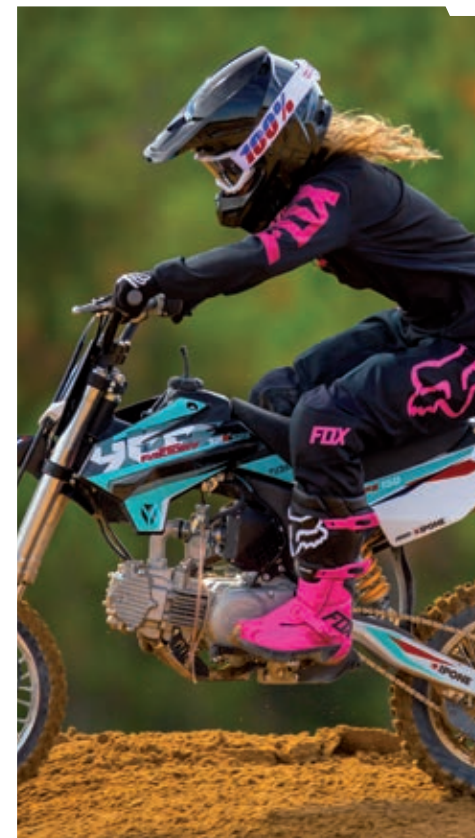

€ 2399

SPÉCIFICATIONS

MOTEUR : MONOCYLINDRE 4 TEMPS
 150cc TYPE KLX / 4 VITESSES
 FOURCHE INVERSÉE RÉGLABLE 735mm
 SUSPENSION ARRIÈRE RÉGLABLE 330mm
 PNEUS AV. & AR. : 60/100/14 - 80/100/12 ARRO®

SPECIFICATIONS

ENGINE TYPE: SINGLE CYLINDER 4 STROKES
 150cc KLX TYPE / 4 GEARS (N1234)
 735mm ADJUSTABLE UPSD FORK
 330mm ADJUSTABLE REAR SUSPENSION
 FRONT & REAR TIRES: 60/100/14 - 80/100/12 ARRO®

2021 FACTORY SP2 150 RACE READY

POINTS FORTS & NOUVEAUTÉS 2021

MOYEURS AVANT / ARRIÈRE ALUMINIUM CNC
 COURONNE 5 TROUS
 PNEUS ARRO® AVANT / ARRIÈRE
 CERCEAU DE ROUE ALUMINIUM 7116 SILVER
 GRAISSEUR SUR COLONNE DE DIRECTION
 SILENCIEUX RACING
 POIGNÉE CAOUTCHOUC YCF
 BAVETTE AMORTISSEUR
 TÉ FOURCHE CNC ET PONTET DE GUIDON 2 POSITIONS
 BRAS OSCILLANT ALUMINIUM 420mm

HIGHLIGHTS & 2021 NEW FEATURES

ALUMINIUM CNC FRONT / REAR HUBS
 REAR SPROCKET 5 FIXATIONS POINTS
 FRONT / REAR ARRO® TIRES
 ALUMINIUM 7116 SILVER RIMS
 GREASING ON STEERING STEM
 RACING MUFFLER
 YCF GRIPS
 MUD FLAP
 CNC CLAMP WITH ADJUSTABLE BAR MOUNT
 420mm ALUMINIUM SWING ARM

FACTORY

150 SP2

800mm / 32 in.



 73Kg / 161 lbs

L : 740mm / W : 29 in.

1190mm / 47 in.

1670mm / 66 in.



€ 3399

SPÉCIFICATIONS

MOTEUR: MONO CYLINDRE 4T, 4 SOUPAPES 190cc
DAYTONA® ANIMA®/ 4 VITESSES
FOURCHE ENGI® INVERSÉE RÉGLABLE 800mm
SUSPENSION ARRIÈRE ENGI® RÉGLABLE 335mm
PNEUS AV. & AR. ARRO® : 60/100/14 - 80/100/12
CARBURATEUR NIBBI® 28

SPECIFICATIONS

ENGINE TYPE: DAYTONA® ANIMA® SINGLE CYLINDER 4V
4 STROKES 190cc/ 4 GEARS (N1234)
800mm ENGI® UPSD ADJUSTABLE FORK
335mm ENGI® ADJUSTABLE REAR SUSPENSION
FRONT & REAR ARRO® TIRES: 60/100/14 - 80/100/12
NIBBI® 28 CARBURETOR

2021 FACTORY SP3 190 CATCH ME IF YOU CAN

POINTS FORTS & NOUVEAUTÉS 2021

BRAS OSCILLANT 460mm
TÉ 170mm
MOYEURS AVANT/ ARRIÈRE ALUMINIUM CNC
POIGNÉE CAOUTCHOUC YCF
BAVETTE AMORTISSEUR
TÉ FOURCHE CNC ET PONTET DE GUIDON 2 POSITIONS
GUIDON YCF 28,6MM
REPOSE PIED INOX
PÉDALE DE FREIN ALUMINIUM
GUIDE CHAÎNE RENFORCÉ

HIGHLIGHTS & 2021 NEW FEATURES

18 IN. SWINGARM
7 IN. TRIPLE CLAMPS
ALUMINIUM CNC FRONT/ REAR HUBS
YCF GRIPS
MUD FLAP
CNC CLAMP WITH ADJUSTABLE BAR MOUNT
YCF FAT BAR 28,6mm HANDLEBAR
INOX FOOT PEGS
ALUMINIUM BRAKE PEDAL
REINFORCED CHAIN GUIDE

FACTORY

190 SP3
DAYTONA

845mm / 33 in.



 **75Kg / 165 lbs**

L : 740mm / W : 29 in.

1195mm / 47 in.

1670mm / 66 in.



€ 1799

SPÉCIFICATIONS

MOTEUR: MONO CYLINDRE 4 TEMPS 125cc
4 VITESSES EMBRAYAGE
FOURCHE INVERSÉE 660mm
SUSPENSION ARRIÈRE RÉGLABLE 270mm
PNEUS AV. & AR.: 100/90/12 - 120/80/12

SPECIFICATIONS

ENGINE TYPE: SINGLE CYLINDER 4 STROKES 125cc
4 GEARS (N1234)
660mm UPSD FORK
270mm ADJUSTABLE REAR SUSPENSION
FRONT & REAR TIRES: 100/90/12 - 120/80/12

2021 SM F125 SUPERMOTO, SUPER FUN!

POINTS FORTS & NOUVEAUTÉS 2021

MOTEUR 125 ZONGSHEN FIDDY RACER
POIGNÉE DE GAZ RÉGLABLE
PNEUS KENDA K702
NOUVELLES ROUES YCF
SELLE BASSE COMPATIBLE PAGE 80
KIT RABAISSÉ ADAPTABLE PAGE 92
POIGNÉE CAOUTCHOUC YCF
TÉ FOURCHE CNC ET PONTET DE GUIDON 2 POSITIONS

HIGHLIGHTS & 2021 NEW FEATURES

ZONGSHEN ENGINE 125 FIDDY RACER
ADJUSTABLE THROTTLE
KENDA TIRES K702
NEW YCF WHEELS
COMPATIBLE LOW SEAT PAGE 80
HEIGHT ADJUSTMENT KIT PAGE 92
YCF GRIPS
CNC CLAMP WITH ADJUSTABLE BAR MOUNT



F125

780mm / 30 in.



 **69Kg / 152 lbs**

L : 740mm / W : 29 in.

1120mm / 44 in.

1610mm / 63 in.



€ 2199

SPÉCIFICATIONS

MOTEUR: MONO CYLINDRE
4 TEMPS 155cc ZONGSHEN/ 4 VITESSES (N1234)
FOURCHE INVERSÉE 735mm
SUSPENSION ARRIÈRE RÉGLABLE 310mm
PNEUS AV. & AR.: 100/90/12 - 120/80/12

SPECIFICATIONS

ENGINE TYPE: SINGLE CYLINDER
4 STROKES ZONGSHEN 155cc/ 4 GEARS (N1234)
735mm UPSD FORK
310mm ADJUSTABLE REAR SUSPENSION
FRONT & REAR TIRES: 100/90/12 - 120/80/12

2021 SM F155 ADRENALINE RUSH

POINTS FORTS & NOUVEAUTÉS 2021

PNEUS KENDA® K702
MOTEUR ZONGSHEN® W155
NOUVELLES ROUES YCF
FILTRE À AIR YCF
FOURCHE RÉGLABLE
POIGNÉE CAOUTCHOUC YCF
TÉ FOURCHE CNC ET POINTET DE GUIDON 2 POSITIONS

HIGHLIGHTS & 2021 NEW FEATURES

KENDA® TIRES
ZONGSHEN® ENGINE W155
NEW YCF WHEELS
YCF AIR FILTER
ADJUSTABLE FRONT FORK
YCF GRIPS
CNC CLAMP WITH ADJUSTABLE BAR MOUNT



F155



800mm/ 32 in.

 **70Kg/ 154 lbs**

L : 740mm/ W: 29 in.

1170mm/ 46 in.

1680mm/ 66 in.



€ 3299

NEW
2021

2021 SM F190
CATCH ME IF YOU CAN

SPÉCIFICATIONS

MOTEUR: MONO CYLINDRE 4T, 4 SOUPAPES 190cc
DAYTONA® ANIMA®/ 4 VITESSES
FOURCHE ENGI® INVERSÉE RÉGLABLE 735mm
SUSPENSION ARRIÈRE DNM® RÉGLABLE 310mm
PNEUS AV. & AR. 100/90/12 - 120/80/12
CARBURATEUR NIBBI® PE28

SPECIFICATIONS

ENGINE TYPE: DAYTONA® ANIMA® SINGLE CYLINDER 4V
4 STROKES 190cc/ 4 GEARS (N1234)
735mm ENGI® UPSD ADJUSTABLE FORK
310mm DNM® ADJUSTABLE REAR SUSPENSION
FRONT & REAR TIRES: 100/90/12 - 120/80/12
NIBBI® PE28 CARBURETOR

POINTS FORTS

NOUVELLES ROUES YCF
PNEUS KENDA® K702
LIGNE D'ÉCHAPPEMENT RACING DOUBLE SORTIE
AMORTISSEUR DNM 1000LBS
MÂÎTRE CYLINDRE AVANT RACING
KIT FREIN RADIAL AVANT ET ARRIÈRE
DISQUE FLOTTANT 220MM

HIGHLIGHTS

NEW YCF WHEELS
KENDA® TIRE K702
COMPLETE RACING EXHAUST TWIN
DNM SHOCK ABSORBER 1000 LBS
FRONT RACING MASTER CYLINDER
FRONT AND REAR RADIAL BRAKE KIT
SEMI FLOATING BRAKE ROTOR 220MM

DAYTONA ENGI KENDA



F150 DAYTONA®



820mm/ 32 in.

 79Kg/ 174 lbs

L : 740mm/ W: 29 in.

1160mm/ 45 in.

1640mm/ 64 in.



€ 1899

SPÉCIFICATIONS

MOTEUR: MONO CYLINDRE
4 TEMPS 125cc/ 4 VITESSES
FOURCHE INVERSÉE 785mm
SUSPENSION ARRIÈRE RÉGLABLE 355mm
PNEUS AV. & AR.: 70/100/17 - 90/100/14

SPECIFICATIONS

ENGINE TYPE: SINGLE CYLINDER
4 STROKES 125cc/ 4 GEARS (N1234)
FORK: 785mm UPSD FORK
REAR SUSPENSION: 355mm ADJUSTABLE
FRONT & REAR TIRES: 70/100/17 - 90/100/14

2021 BIGY 125 MX EASY TO PICK UP

POINTS FORTS & NOUVEAUTÉS 2021

ROUE AVANT 17'/ ARRIÈRE 14'
BOÎTE À AIR
POIGNÉE CAOUTCHOUC YCF
BAVETTE AMORTISSEUR
TÉ FOURCHE CNC ET PONTET DE GUIDON 2 POSITIONS
LEVIER DE FREIN PLIABLE
SÉLECTEUR PLUS COURT

HIGHLIGHTS & 2021 NEW FEATURES

FRONT 17'/ REAR 14' WHEEL
AIR BOX
YCF GRIPS
MUD FLAP
CNC CLAMP WITH ADJUSTABLE BAR MOUNT
FOLDABLE FRONT BRAKE LEVER
SHORTER GEARSHIFT



125 MX



880mm / 34 in.

 80Kg / 176 lbs

L : 740mm / W : 29 in.

1300mm / 51 in.

1875mm / 74 in.



€ 2199

SPÉCIFICATIONS

MOTEUR: MONO CYLINDRE
 4 TEMPS 150cc/ 4 VITESSES
 FOURCHE INVERSÉE 785mm
 SUSPENSION ARRIÈRE RÉGLABLE 355mm
 PNEUS AV. & AR.: 70/100/17 - 90/100/14

SPECIFICATIONS

ENGINE TYPE: SINGLE CYLINDER
 4 STROKES 150cc/ 4 GEARS (N1234)
 FORK: 785mm UPSD FORK
 REAR SUSPENSION: 355mm ADJUSTABLE
 FRONT & REAR TIRES: 70/100/17 - 90/100/14

2021 BIGY 150 MX BIGGER! FASTER! STRONGER!

POINTS FORTS & NOUVEAUTÉS 2021

ROUE AVANT 17"/ ARRIÈRE 14'
 BOÎTE À AIR
 POIGNÉE CAOUTCHOUC YCF
 BAVETTE AMORTISSEUR
 TÉ FOURCHE CNC ET PONTET DE GUIDON 2 POSITIONS
 LEVIER DE FREIN PLIABLE
 SÉLECTEUR PLUS COURT

HIGHLIGHTS & 2021 NEW FEATURES

FRONT 17"/ REAR 14' WHEEL
 AIR BOX
 YCF GRIPS
 MUD FLAP
 CNC CLAMP WITH ADJUSTABLE BAR MOUNT
 FOLDABLE FRONT BRAKE LEVER
 SHORTER GEARSHIFT



150 MX

880mm / 34 in.



 81Kg / 178 lbs

L : 740mm / W : 29 in.

1300mm / 51 in.

1875mm / 74 in.



€ 2999

SPÉCIFICATIONS

MOTEUR: MONOCYLINDRE 4 TEMPS
190cc ZONGSHEN/ 5 VITESSES
FOURCHE INVERSÉE RÉGLABLE 800mm
SUSPENSION ARRIÈRE RÉGLABLE 355mm
PNEUS AV. & AR.: 70/100/17 - 90/100/14 ARRO®
CARBURATEUR NIBBI® 28

SPECIFICATIONS

ENGINE TYPE: SINGLE CYLINDER 4 STROKES
190cc ZONGSHEN/ 5 GEARS
800mm ADJUSTABLE UPSD FORK
355mm ADJUSTABLE REAR SUSPENSION
FRONT & REAR TIRES: 70/100/17 - 90/100/14 ARRO®
NIBBI® 28 CARBURETOR

2021 BIGY 190 MX ZE FACTORY ELECTRIC START

POINTS FORTS & NOUVEAUTÉS 2021

ROUE AVANT 17'/ ARRIÈRE 14'
BOÎTE À AIR
JANTES ALUMINIUM 7116
MOYEURS AVANT/ ARRIÈRE ALUMINIUM CNC
DÉMARREUR ÉLECTRIQUE
POIGNÉE CAOUTCHOUC YCF
BAVETTE AMORTISSEUR
TÉ FOURCHE CNC ET PONTET DE GUIDON 2 POSITIONS
REPOSE PIED INOX
PÉDALE DE FREIN ALUMINIUM
GUIDE CHAÎNE RENFORCÉ

HIGHLIGHTS & 2021 NEW FEATURES

FRONT 17'/ REAR 14' WHEEL
AIR BOX
ALUMINIUM 7116 RIMS
ALUMINIUM FRONT/ REAR CNC HUBS
ELECTRIC START
YCF GRIPS
MUD FLAP
CNC CLAMP WITH ADJUSTABLE BAR MOUNT
INOX FOOT PEGS
ALUMINIUM BRAKE PEDAL
REINFORCED CHAIN GUIDE



190 MX⁺ FACTORY



890mm / 35 in.

 89Kg / 196 lbs

L : 740mm / W : 29 in.

1305mm / 51 in.

1880mm / 74 in.



€ 3499

SPÉCIFICATIONS

MOTEUR: MONO CYLINDRE 4T, 4 SOUPAPES 190cc
 DAYTONA® ANIMA®/ 4 VITESSES
 MOTEUR 4 VITESSES
 FOURCHE ENGI® INVERSÉE RÉGLABLE 800mm
 SUSPENSION ARRIÈRE ENGI® RÉGLABLE 355mm
 PNEUS AV. & AR.: 70/100/17 - 90/100/14 ARRO®
 CARBURATEUR NIBBI® 28

SPECIFICATIONS

ENGINE TYPE: DAYTONA® ANIMA® SINGLE CYLINDER 4V
 4 STROKES 190cc/ 4 GEARS (N1234)
 4 SPEED ENGINE
 800mm ENGI® UPSD ADJUSTABLE FORK
 355mm ENGI® ADJUSTABLE REAR SUSPENSION
 FRONT & REAR TIRES: 70/100/17 - 90/100/14 ARRO®
 NIBBI® 28 CARBURETOR

DAYTONA ENGI® ARRO™

**2021 BIGY 190 MX FACTORY DAYTONA
 FIRST TO THE FINISH LINE**

POINTS FORTS & NOUVEAUTÉS 2021

BOÎTE À AIR
 SURMOUSSE DE GUIDON CAOUTCHOUC 3D
 MOTEUR 4 VITESSES
 BRAS OSCILLANT ALUMINIUM
 REPOSE PIED INOX
 PÉDALE DE FREIN ALUMINIUM
 POIGNÉE CAOUTCHOUC YCF
 BAVETTE AMORTISSEUR
 TÉ FOURCHE CNC ET PONTET DE GUIDON 2 POSITIONS
 GUIDON YCF 28,6MM
 PÉDALE DE FREIN ALUMINIUM
 GUIDE CHAÎNE RENFORCÉ

HIGHLIGHTS & 2021 NEW FEATURES

AIR BOX
 RUBBER BAR PAD
 DAYTONA 4 SPEED ENGINE
 ALUMINIUM SWING ARM
 INOX FOOTPEGS
 ALUMINIUM BRAKE PEDAL
 YCF GRIPS
 MUD FLAP
 CNC CLAMP WITH ADJUSTABLE BAR MOUNT
 YCF FAT BAR 28,6mm HANDLEBAR
 ALUMINIUM BRAKE PEDAL
 REINFORCED CHAIN GUIDE



190 MX FACTORY DAYTONA



890mm/ 35 in.

 84 Kg / 185 lbs

L : 740mm / W : 29 in.

1305mm / 51 in.

1880mm / 74 in.

**PADDOCK
PADDOCK**



ORIFLAMME
FLAG

→ YCF-FLAG-3M (3 METERS-118 in.)

€ 139



TONNELLE 3 X 3M YCF (100 % ÉTANCHE) VELCRO INTÉGRAL AUTOUR DU TOIT
YCF PIT TENT 3 X 3M (100 % WATERPROOF) INTEGRAL VELCRO AROUND THE ROOF

→ TONNELLEYCF-3

€ 199



RUBALISE DE TERRAIN (ROULEAU DE 100 MÈTRES)
BANNER ROOL (100 METERS ROLL)

→ RUB-1

€ 9



BANDEROLE DE TERRAIN EN FEUTRINE 1 X 25M
BANNER ROLL 1 X 25M

→ FEUTRINE-1

€ 99



BANNER YCF 2 X 0,50M
YCF BANNER 2 X 0,50M

→ BANNER

€ 29



BÂCHE MOTO
MOTORCYCLE COVER

→ BIKECOVER-BL

€ 29

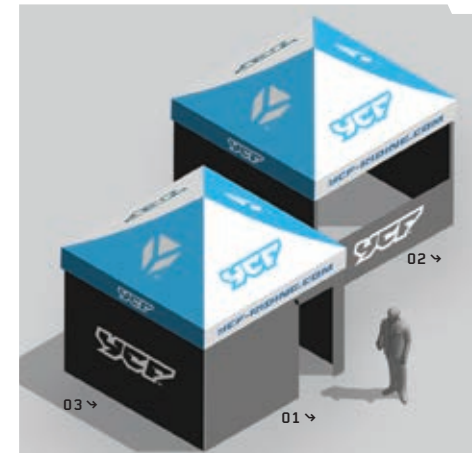

CÔTÉ DE TONNELLE 3 X 3M AVEC PORTE ZIPPÉE
PIT TENT SIDE 3 X 3M WITH ZIP DOOR

01 → PORTE-1

€ 49

DEMI CÔTÉ DE TONNELLE
PIT TENT HALF SIDE

02 → DEMICOTE-1

€ 29

CÔTÉ DE TONNELLE 3 X 3M
PIT TENT SIDE 3 X 3M

03 → COTE-1

€ 39



CHAISE PLIABLE YCF
YCF FOLDING CHAIR

→ CHAIR-BL

€ 29



TREPIED ALUMINIUM NOIR/ BLEU/ VERT/ ORANGE/ ROUGE - HAUTEUR 40 cm

ALUMINIUM BIKE STAND BLACK/ BLUE/ GREEN/ ORANGE/ RED - HEIGHT 15,7 in.

→ TREPIED + COLOR

€ 79

**NEW
2021**



BÉQUILLE ROUE AR RÉGLABLE AVEC ROULETTE
REAR STAND. COMES WITH HEIGHT ADJUSTABLE FORKS FOR SPOOLS

→ STAND1MOTO-04

€ 49

**NEW
2021**

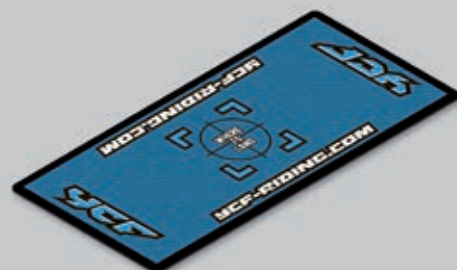

TAPIS SOL YCF 180X80 CM
YCF RUBBER MAT 180X80 CM (70in x 31 in)

→ TAPISSOL-3

€ 69

**NEW
2021**



TREPIED ACIER NOIR pour 50/88 - HAUTEUR 32 cm
50/88 STEEL BIKE STAND BLACK - HEIGHT 12 in.

→ TREPIED02-BK

€ 59



TREPIED ACIER NOIR - HAUTEUR 40 cm
STEEL BIKE STAND BLACK - HEIGHT 15,7 in.

→ TREPIED01-BK

€ 59

**NEW
2021**



BÉQUILLE ROUE AR RÉGLABLE
ADJUSTABLE REAR WHEEL STAND

→ STAND1MOTO-02

€ 35

**TEXTILES
APPAREL**



PARAPLUIE YCF
YCF UMBRELLA

UMBRELLA

€ 29



BONNET YCF
YCF BEANIE

→ BYCF01-BK

€ 15



BENT CASQUETTE YCF ROUGE/BLANCHE
YCF RED/WHITE CURVED BILL HAT

→ CYCF03-RD

€ 19



CASQUETTE BASEBALL YCF NOIRE/BLANCHE
YCF BLACK/WHITE SNAPBACK HAT

→ CYCF03-BK

€ 19



SWEAT À CAPUCHE ZIPPÉ YCF (S/ M/ L/ XL/ XXL)
YCF ZIP HOODIE (SIZE: S/ M/ L/ XL/ XXL)

→ SWEAT02RD + TAILLE/ SIZE

€ 59



CHEMISETTE RACING YCF (S/ M/ L/ XL/ XXL)
SHORT-SLEEVED RACING SHIRT (S/ M/ L/ XL/ XXL)

→ CHEMISETTE-2 + TAILLE/ SIZE

€ 39



T-SHIRT YCF (TAILLE: S/ M/ L/ XL/ XXL)
YCF T-SHIRT (SIZE: S/ M/ L/ XL/ XXL)

→ TSYCFRD + TAILLE/ SIZE

€ 19



T-SHIRT ENFANT YCF (TAILLE: 4 ANS/ 8 ANS)
YCF YOUTH T-SHIRT (SIZE: 4 YEARS/ 8 YEARS)

→ TSK02BL-4 (4 YEARS)
→ TSK02BL-8 (8 YEARS)

€ 19

GRAPHICS & PLASTICS



ACCESSOIRES PLASTIQUES

KITS DÉCO/ GRAPHIC KITS	54
PERSONNALISATION/ CUSTOMIZATION	61
KITS PLASTIQUES/ PLASTIC KITS	62

D'COR® KITS DÉCO/ GRAPHIC KITS



KIT DÉCO MONSTER (GAMME PILOT 2018-2021/ FACTORY 2017-2021)
MONSTER ENERGY® GRAPHIC KIT (RANGE PILOT 2018-2021/ FACTORY 2017-2021)

→ 20-90-106

€ 99



KIT DÉCO GEICO (GAMME PILOT 2018-2021/
FACTORY 2017-2021)
GEICO® GRAPHIC KIT (RANGE PILOT 2018-2021/
FACTORY 2017-2021)

→ 20-90-107

€ 99



KIT DÉCO STAR RACING (GAMME PILOT 2018-2021/
FACTORY 2017-2021)
STAR RACING GRAPHIC KIT (RANGE PILOT 2018-2021
/FACTORY 2017-2021)

→ 20-90-108

€ 99



⚠ KIT COMPLET POUR GAMME 2007 À 2021
COMPLETE KIT FOR RANGE 2007 TO 2021



KIT DÉCO GEICO®
 (GAMME START 2008-2019/ PILOT 2013-2015/ FACTORY 2012-2015)
 GEICO® GRAPHIC KIT
 (RANGE START 2008-2019/ PILOT 2013-2015/ FACTORY 2012-2015)

→ KD17-GEICO-01 € 75



KIT DÉCO MONSTER®
 (GAMME START 2008-2019/ PILOT 2013-2015/ FACTORY 2012-2015)
 MONSTER ENERGY® GRAPHIC KIT
 (RANGE START 2008-2019/ PILOT 2013-2015/ FACTORY 2012-2015)

→ KD17-MONSTER-01 € 75



KIT DÉCO DE CADRE POUR FACTORY
 GRAPHIC KIT FOR FACTORY FRAME

→ FGKFP-BK € 19



KIT DÉCO GEICO® (GAMME PILOT 2016-2021/ FACTORY 2016-2018)
 GEICO® GRAPHIC KIT (RANGE PILOT 2016-2021/ FACTORY 2016-2018)

→ KD17-GEICO-02 € 75



KIT DÉCO MONSTER® (GAMME PILOT 2016-2021/ FACTORY 2016-2018)
 MONSTER ENERGY® GRAPHIC KIT (RANGE PILOT 2016-2021/ FACTORY 2016-2018)

→ KD17-MONSTER-02 € 75



KIT DÉCO DE CADRE POUR PILOT
 GRAPHIC KIT FOR PILOT FRAME

→ FGKP-BK € 16

**NEW
2021**



**ORIGINAL YCF®
KITS DÉCO/ GRAPHIC KITS**



KIT DÉCO 50 YCF 2021
50 YCF GRAPHIC KIT 2021

→ KD50A2021 (50 SEULEMENT/ ONLY) € 69



KIT DÉCO LITE 88 2021
GRAPHIC KIT LITE 88 2021

→ KD88L2021 € 69



KIT DÉCO LITE 125 2021
GRAPHIC KIT LITE 125 2021

→ KD125L2021 € 69



KIT DÉCO START W88 2021
GRAPHIC KIT START W88E 2021

→ KD88E2021 € 69



KIT DÉCO 50 YCF 2021
50 YCF GRAPHIC KIT 2021

→ KD50E2021 (50 SEULEMENT/ ONLY) € 69



KIT DÉCO START 88SE 2021
GRAPHIC KIT START 88SE 2021

→ KD88SE2021 € 69



KIT DÉCO START 125 2021
GRAPHIC KIT START 125 2021

→ KD1252021 € 69



KIT DÉCO START 125SE 2021
GRAPHIC KIT START 125SE 2021

→ KD125SE2021 € 69



KIT DÉCO PILOT 125 2021
GRAPHIC KIT PILOT 125 2021

→ KDP1252021

€ 69



KIT DÉCO PILOT 150 2021
GRAPHIC KIT PILOT 150 2021

→ KDP1502021

€ 69



KIT DÉCO SM 125 2021
GRAPHIC KIT SM 125 2021

→ KDSM1252021

€ 69



KIT DÉCO FACTORY SP2 2021
GRAPHIC KIT FACTORY SP2 2021

→ KDSP22021

€ 69



KIT DÉCO FACTORY SP3 190 2021
GRAPHIC KIT FACTORY SP3 190 2021

→ KDSP31902021

€ 69



KIT DÉCO SM 150 2021
GRAPHIC KIT SM 150 2021

→ KDSM1502021

€ 69



KIT DÉCO SM 190 2021
GRAPHIC KIT SM 190 2021

→ KDSM1902021

€ 69

**NEW
2021**



**ORIGINAL YCF®
KITS DÉCO/ GRAPHIC KITS**

3M



KIT DÉCO BIGY FACTORY 190 MX DAYTONA® 2021
GRAPHICS KIT BIGY FACTORY 190 MX DAYTONA® 2021

→ KDBIGYFD19021

€ 99



KIT DÉCO BIGY 125 MX 2021
GRAPHICS KIT BIGY 125 MX 2021

→ KDBIGY12521

€ 99



KIT DÉCO BIGY 150 MX 2021
GRAPHICS KIT BIGY 150 MX 2021

→ KDBIGY15021

€ 99

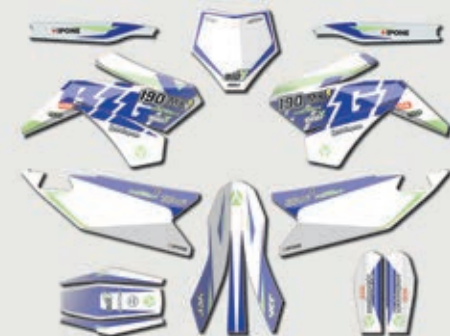

KIT DÉCO BIGY FACTORY 190 MX ZE 2021
GRAPHICS KIT BIGY FACTORY 190 MX ZE 2021

→ KDBIGYFZE19021

€ 99





KIT DÉCO BIGY MONSTER
BIGY MONSTER ENERGY® GRAPHIC KIT

→ 20-90-109

€ 119

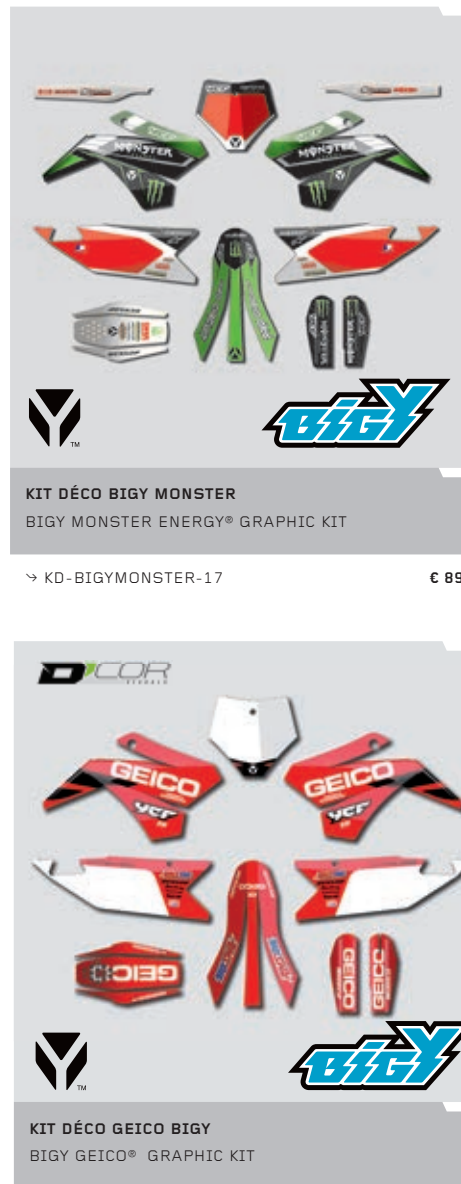

KIT DÉCO BIGY MONSTER
BIGY MONSTER ENERGY® GRAPHIC KIT

→ KD-BIGYMONSTER-17

€ 89

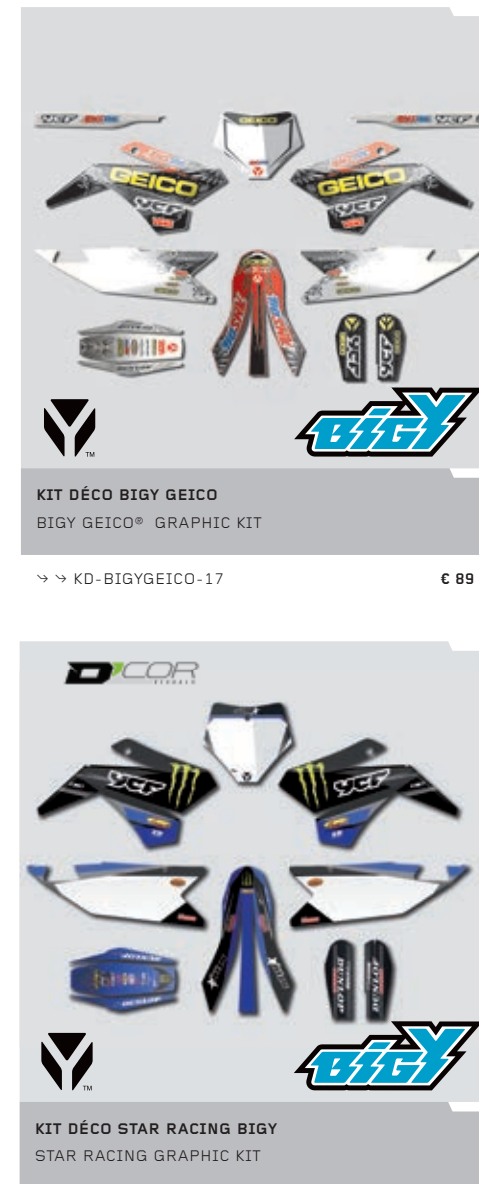

KIT DÉCO BIGY GEICO
BIGY GEICO® GRAPHIC KIT

→ KD-BIGYGEICO-17

€ 89



KIT DÉCO GEICO BIGY
BIGY GEICO® GRAPHIC KIT

→ 20-90-110

€ 119



KIT DÉCO STAR RACING BIGY
STAR RACING GRAPHIC KIT

→ 20-90-111

€ 119



PERSONNALISATION CUSTOMIZATION

31 968 COMBINAISONS

2 COULEURS DE PLAQUES (PLASTIQUE)
8 COULEURS DE FONDS DE PLAQUES
999 CHIFFRES (DESIGN YCF)
2 COULEURS DE CHIFFRES

YCF ID 1,0 EST LA 1^{ÈRE} ÉTAPE DU PROGRAMME DE PERSONNALISATION DE VOTRE MOTO YCF, VOUS POUVEZ MAINTENANT CRÉER VOTRE PLAQUE NUMÉRO ORIGINALE GRÂCE À UN LARGE CHOIX DE DESIGNS GRAPHIQUES ET DE COULEURS.

DISPONIBLE CHEZ VOTRE REVENDEUR.

31 968 COMBINATIONS

2 (PLASTIC) PLATE COLORS
8 BACKGROUND PLATE COLORS
999 INDIVIDUAL CHARACTERS (YCF DESIGN)
2 COLORS AVAILABLE

YCF ID 1,0 IS THE FIRST STAGE OF THE CUSTOMIZATION PROGRAMME FOR YOUR YCF MINI-BIKE, YOU CAN NOW CREATE YOUR OWN ORIGINAL NUMBER PLATE THANKS TO A WIDE CHOICE OF GRAPHIC DESIGNS AND COLOURS.

AVAILABLE AT YOUR RETAILER.



NUMÉRO POUR 3 PAR PLAQUE
NUMBERS FOR 3 PER PLATE

01 ↘ NUM./8CM (NOIR/ BLACK)
01 ↘ NUMW./8CM (BLANC/ WHITE) (x3) € 4

NUMÉRO POUR 2 PAR PLAQUE
NUMBERS FOR 2 PER PLATE

02 ↘ NUM./11CM (NOIR/ BLACK)
02 ↘ NUMW./11CM (BLANC/ WHITE) (x3) € 5

NUMÉRO POUR 1 PAR PLAQUE
NUMBERS FOR 1 PER PLATE

03 ↘ NUM./18CM (NOIR/ BLACK)
03 ↘ NUMW./18CM (BLANC/ WHITE) (x3) € 6



PLANCHE DE STICKERS
STICKERS SHEET

↘ STSVYCF

€ 9

KITS PLASTIQUES YCF
YCF PLASTIC KITS



**NEW
2021**



PLAQUE AVANT POUR LITE 88 2020-21/ LITE 125/ START 88SE 2020-21/ START 125/ PILOT/ FACTORY/ SM
NOIR/ ROSE/ ROUGE/ BLANCHE/ BLEUE/ VERTE/ JAUNE/ ORANGE/ GRIS

FRONT NUMBER PLATE FOR LITE 88 2020-21/ LITE 125/ START 88SE 2020-21/ START 125/ PILOT/ FACTORY/ SM
BLACK/ PINK/ RED/ WHITE/ BLUE/ GREEN/ YELLOW/ ORANGE/ GREY

→ YC110-0212-07 + COLOR

€ 19

→ ANCIENNE RÉF : YC110-0212-02 + COLOR (LITE F88 - START F88 AVANT 2020)

€ 19



**NEW
2021**



GARDE BOUE AVANT POUR LITE 125/ START 125/ PILOT/ FACTORY/ SM (2014-2021)/ START 88SE 2021
NOIR/ ROSE/ ROUGE/ BLANC/ BLEU/ VERT/ JAUNE/ ORANGE/ GRIS

FRONT FENDER FOR LITE 125/ START 125/ PILOT/ FACTORY/ SM (2014-2021)/ START 88SE 2021
BLACK/ PINK/ RED/ WHITE/ BLUE/ GREEN/ YELLOW/ ORANGE/ GREY

→ YC110-032-02 + COLOR

€ 19

→ ANCIENNE RÉF : YC110-032 + COLOR (LITE F88 - START F88 AVANT 2020)

€ 19



OUIE RADIATEUR DROITE POUR LITE/ START 2007-2019/ PILOT 2007-17/ FACTORY 2007-16
NOIRE/ ROUGE/ BLANCHE/ VERTE/ ORANGE
 RIGHT SHROUD FOR LITE/ START 2007-2019/ PILOT 2007-17/ FACTORY 2007-16
 BLACK/ RED/ WHITE/ GREEN/ ORANGE

→ YC110-14-052 + COLOR

€ 15



OUIE RADIATEUR GAUCHE POUR LITE/ START 2007-2019/ PILOT 2007-17/ FACTORY 2007-16
NOIRE/ ROUGE/ BLANCHE/ VERTE/ ORANGE
 LEFT SHROUD FOR LITE/ START 2007-2019/ PILOT 2007-17/ FACTORY 2007-16
 BLACK/ RED/ WHITE/ GREEN/ ORANGE

→ YC110-14-062 + COLOR

€ 15



OUIE RADIATEUR DROITE EN 2 PARTIES POUR PILOT 2018-21/ FACTORY 2017-21/ START 2020-21
NOIRE/ ROUGE/ BLANCHE/ VERTE/ JAUNE/ ORANGE/ GRIS/ BLEU
 RIGHT SHROUD 2 PARTS FOR PILOT 2018-21/ FACTORY 2017-21/ START 2020-21
 BLACK/ PINK/ RED/ WHITE/ BLUE/ GREEN/ YELLOW/ ORANGE/ GREY/ BLUE

→ YC110-14-059 + COLOR

€ 19



OUIE RADIATEUR GAUCHE EN 2 PARTIES POUR PILOT 2018-21/ FACTORY 2017-21/ START 2020-21
NOIRE/ ROUGE/ BLANCHE/ VERTE/ JAUNE/ ORANGE/ GRIS/ BLEU
 LEFT SHROUD 2 PARTS FOR PILOT 2018-21/ FACTORY 2017-21/ START 2020-21
 BLACK/ RED/ WHITE/ GREEN/ YELLOW/ ORANGE/ GREY/ BLUE

→ YC110-14-069 + COLOR

€ 19



**PLAQUE LATÉRALE DROITE POUR LITE/ START 2017-2021/ PILOT 2007-2015/ FACTORY 2007-2015
NOIRE/ ROSE/ ROUGE/ BLANCHE/ BLEUE/ VERTE/ JAUNE/ ORANGE**

RIGHT NUMBER PLATE FOR LITE/ START 2017-2021/ PILOT 2007-2015/ FACTORY 2007-2015
BLACK/ PINK/ RED/ WHITE/ BLUE/ GREEN/ YELLOW/ ORANGE

→ YC110-14-022 + COLOR

€ 15



**PLAQUE LATÉRALE GAUCHE POUR LITE/ START 2017-2021/ PILOT 2007-2015/ FACTORY 2007-2015
NOIRE/ ROSE/ ROUGE/ BLANCHE/ BLEUE/ VERTE/ JAUNE/ ORANGE**

LEFT NUMBER PLATE FOR LITE/ START 2017-2021/ PILOT 2007-2015/ FACTORY 2007-2015
BLACK/ PINK/ RED/ WHITE/ BLUE/ GREEN/ YELLOW/ ORANGE

→ YC110-14-042 + COLOR

€ 15



**PLAQUE LATÉRALE DROITE POUR PILOT 2016-21/ FACTORY 2016-21
NOIRE/ ROUGE/ BLANCHE/ VERTE/ JAUNE/ ORANGE/ BLEU/ GRIS**

RIGHT NUMBER PLATE FOR PILOT 2016-21/ FACTORY 2016-21
BLACK/ RED/ WHITE/ GREEN/ YELLOW/ ORANGE/ BLUE/ GREY

→ YC110-14-028 + COLOR

€ 15



**PLAQUE LATÉRALE GAUCHE POUR PILOT 2016-21/ FACTORY 2016-21
NOIRE/ ROUGE/ BLANCHE/ VERTE/ JAUNE/ ORANGE/ BLEU/ GRIS**

LEFT NUMBER PLATE FOR PILOT 2016-21/ FACTORY 2016-21
BLACK/ WHITE BLACK/ RED/ WHITE/ GREEN/ YELLOW/ ORANGE/ BLUE/ GREY

→ YC110-14-048 + COLOR

€ 15



GARDE BOUE ARRIÈRE POUR LITE/ START 2007-2021/ PILOT 2007-2015/ FACTORY 2007-2015
NOIR/ ROSE/ ROUGE/ BLANC/ BLEU/ VERT/ JAUNE/ ORANGE
 REAR FENDER FOR LITE/ START 2007-2021/ PILOT 2007-2015/ FACTORY 2007-2015
 BLACK/ PINK/ RED/ WHITE/ BLUE/ GREEN/ YELLOW/ ORANGE

→ YC110-14-012 + COLOR

€ 15



GARDE BOUE ARRIÈRE POUR PILOT 2016-21/ FACTORY 2016-21
NOIR/ BLANC/ ROUGE/ VERT/ JAUNE/ ORANGE/ BLEU/ GRIS
 REAR FENDER FOR PILOT 2016-21/ FACTORY 2016-21
 BLACK/ WHITE/ RED/ GREEN/ YELLOW/ ORANGE

→ YC110-14-018 + COLOR

€ 15



PAIRE DE PROTECTIONS FOURCHE (ADAPTABLE SUR TOUTES LES FOURCHES)
NOIRES/ VERTES/ ORANGES/ JAUNES/ BLANCHES/ ROUGES/ BLEUES
 PAIR OF FORK GUARD (WITH SLOTTED HOLE ADAPTABLE TO ALL FORKS)
 BLACK/ GREEN/ ORANGE/ YELLOW/ WHITE/ RED/ BLUE

01 → PFYCF12 + COLOR (735mm)
 01 → YC110-0418-01WH (BLANC/ WHITE - 660mm)
 01 → YC110-0418-01BK (NOIR/ BLACK - 660mm)
 02 → PFMARZO (NOIR/ BLACK)

€ 30



→ FOR 50 ONLY



PAIRE DE PROTECTIONS FOURCHE POUR YCF 50 BLANCHE/ ROUGE/ JAUNE/ ORANGE/ VERTE/ BLEUE
FORK GUARD FOR YCF 50 WHITE/ RED/ YELLOW/ ORANGE/ GREEN/ BLUE

→ YC50-0418 + COLOR

€ 19



GARDE BOUE AVANT YCF NOIR/ ROUGE/ BLANC/ VERT/ JAUNE/ ORANGE/ BLEU YCF/ BLEU/ GRIS
 YCF FRONT FENDER BLACK/ RED/ WHITE/ GREEN/ YELLOW/ ORANGE/ YCF BLUE/ BLUE/ GREY

→ YC110-032-10 + COLOR

€ 19



GARDE BOUE ARRIÈRE YCF NOIR/ ROUGE/ BLANC/ VERT/ JAUNE/ ORANGE/ BLEU/ GRIS
 YCF REAR FENDER BLACK/ RED/ WHITE/ GREEN/ YELLOW/ ORANGE/ BLUE/ GREY

→ YC110-14-019 + COLOR

€ 19



OUIE RADIATEUR YCF DROITE NOIRE/ ROUGE/ BLANCHE/ VERTE/ JAUNE/ ORANGE/ BLEU/ GRIS
 YCF RIGHT SHROUD 2 PARTS BLACK/ RED/ WHITE/ GREEN/ YELLOW/ ORANGE/ BLUE/ GREY

→ YC110-14-058 + COLOR

€ 19



OUIE RADIATEUR YCF GAUCHE NOIRE/ ROUGE/ BLANCHE/ VERTE/ JAUNE/ ORANGE/ BLEU/ GRIS
 YCF LEFT SHROUD 2 PARTS BLACK/ RED/ WHITE/ GREEN/ YELLOW/ ORANGE/ BLUE/ GREY

→ YC110-14-068 + COLOR

€ 19



PLAQUE AVANT YCF NOIRE/ ROUGE/ BLANCHE/ VERTE/ JAUNE/ ORANGE/ BLEUE YCF/ BLEU/ GRIS
YCF FRONT NUMBER PLATE BLACK/ RED/ WHITE/ GREEN/ YELLOW/ ORANGE/ YCF BLUE/ BLUE/ GREY

→ YC110-0212-09 + COLOR

€ 19



PLAQUE LATÉRALE YCF DROITE NOIRE/ ROUGE/ BLANCHE/ VERTE/ JAUNE/ ORANGE/ BLEU/ GRIS
YCF RIGHT NUMBER PLATE BLACK/ RED/ WHITE/ GREEN/ YELLOW/ ORANGE/ BLUE/ GREY

→ YC110-14-029 + COLOR

€ 19



PLAQUE LATÉRALE YCF GAUCHE NOIRE/ ROUGE/ BLANCHE/ VERTE/ JAUNE/ ORANGE/ BLEU/ GRIS
YCF LEFT NUMBER PLATE BLACK/ RED/ WHITE/ GREEN/ YELLOW/ ORANGE/ BLUE/ GREY

→ YC110-14-049 + COLOR

€ 19



→ FOR 50 ONLY



**KIT PLASTIQUE YCF 50 BLANC/ NOIR/ ROUGE/
JAUNE/ ORANGE/ VERT/ ROSE/ BLEU**
YCF 50 PLASTIC KIT WHITE/ BLACK/ RED/ YELLOW/
ORANGE/ GREEN/ PINK/ BLUE

→ KPYCF50-01 + COLOR

€ 60

**GARDE BOUE AVANT POUR YCF 50 ET LITE 88 2020
BLANC/ NOIR/ ROUGE/ JAUNE/ ORANGE/ VERT
ROSE/ BLEU**
FRONT FENDER FOR YCF 50 AND LITE 88 2020
WHITE/ BLACK/ RED/ YELLOW/ ORANGE/ GREEN
PINK/ BLUE

01 → YC50-031-01 + COLOR

€ 15

→ ANCIENNE RÉF : YC50-031 + COLOR
(AVANT 2020)

€ 15



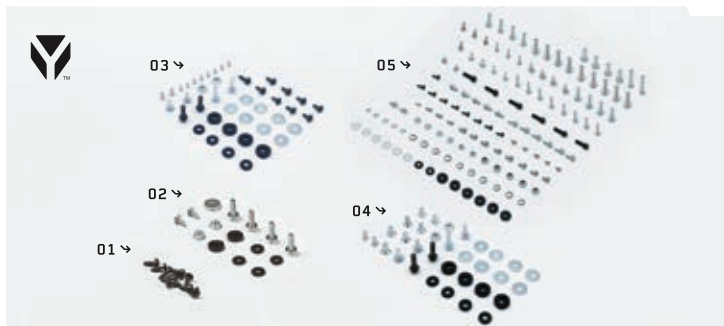

KIT VIS POUR FIXER LES PLASTIQUES SUR LA SELLE
BOLT KIT FOR FIXING THE PLASTICS TO THE SEAT

01 → KVP € 2

KIT VISSERIE POUR KIT PLASTIQUE (2+2 POUR RÉSERVOIR + 2 POUR SELLE SUR CADRE)
BOLT KIT FOR PLASTIC KIT (2+2 FOR FUEL TANK + 2 FOR SEAT ON FRAME)

02 → KVP-2 € 3

KIT VISSERIE POUR PLASTIQUE START/ PILOT/ FACTORY
BOLT KIT FOR PLASTIC KIT START/ PILOT/ FACTORY

**NEW
2021**

03 → KVP-3 € 6

KIT VISSERIE POUR PLASTIQUE BIGY
BOLT KIT FOR PLASTIC KIT BIGY

**NEW
2021**

04 → KVP-4 € 6

KIT VIS COMPLET YCF
COMPLETE YCF BOLT KIT

**NEW
2021**

05 → KVP-5 € 39



PROTÈGE DISQUE AVANT BLEU/ ROUGE/ NOIR/ VERT/ ORANGE/ BLANC/ JAUNE
FRONT BRAKE PROTECTION BLUE/ RED/ BLACK/ GREEN/ ORANGE/ WHITE/ YELLOW

→ YC110-0627 + COLOR € 29



**NEW
2021**

**PASSE DURITE FREIN AVANT CNC NOIR/ ORANGE/
ROUGE/ VERT/ BLEU**
OIL STEEL LINE RETAINER BLACK/ ORANGE/RED/
GREEN/ BLUE/

→ YC110-0403-06 + COLOR € 16



PASSE DURITE YCF
YCF BRAKE HOSE

01 → YC110-0403-05 € 5



**KIT RONDELLE CNC POUR RÉSERVOIR ET KIT PLAS-
TIQUE, VENDU AVEC LES VIS BTR (2XM5/ 2XM6/ 1XM8)**
NOIR/ ROUGE/ ORANGE/ VERT/ BLEU
CNC WASHER AND BTR SCREW FOR TANK
AND PLASTIC KIT (2XM5/ 2XM6/ 1XM8)
BLACK/ RED/ ORANGE/ GREEN/ BLUE

→ KRV + COLOR € 19



KIT COMPLET PHARES POUR START/ LITE/ FACTORY SP1 & SP2/ BIGY 125 & 150
LIGHT KIT FOR START/ LITE/ FACTORY SP1 & SP2/ BIGY 125 & 150

→ KL1E € 119
→ KL1 € 169
01 → YC110-1525-02 € 29



PLAQUE PHARE AVANT YCF NOIRE/ BLANCHE
YCF HEADLIGHT BLACK/ WHITE

→ YC110-1523-02 + COLOR € 59

FACTORY SP III

YCF FACTORY DAYTONA® 190 ANIMA
RIDER : MIKE ALESSI
TEAM : YCF USA



MOTORCYCLE PARTS

PIÈCES MOTO

GUIDONS/ HANDLE BARS	72
POIGNÉES/ LEVERS	74
FOURCHES/ FORKS	76
CADRES/ FRAMES	79
SELLES/ SEATS	80
RÉSERVOIRS/ FUEL TANKS	81
FREINS/ BRAKES	82
BRAS OSCILLANTS/ SWING ARMS	90
AMORTISSEURS/ SHOCK ABSORBERS	92
ROUES/ WHEELS	93
JANTES & MOYEUX/ RIMS & HUBS	93
PNEUS/ TIRES	100
REPOSE-PIEDS & SABOTS/ FOOT PEGS & SKID PLATES	102
SÉLECTEURS/ SHIFT LEVERS	103
KITS CHAÎNES/ SPROCKET KITS	104
OUTILS/ TOOLS	106
ENGI®/ ENGI®	108



GUIDONS HANDLE BARS



MOUSSE GUIDON SANS BARRE
NOIRE/ ROSE/ VERTE/ ROUGE/ ORANGE/ BLEUE/ JAUNE/ BLANCHE
HANDLEBAR PAD WITHOUT CROSSBAR
BLACK/ PINK/ GREEN/ RED/ ORANGE/ BLUE/ YELLOW/ WHITE

→ YC110-01046 + COLOR

€ 12



MOUSSE GUIDON CAOUTCHOUC 3D
HANDLEBAR PAD WITH RUBBER COVER 3D

→ YC110-0133-01BK

€ 12



→ FOR 50 ONLY

MOUSSE GUIDON YCF 50 SANS BARRE
NOIRE/ ROSE/ VERTE/ ROUGE/ ORANGE/ BLEUE/ JAUNE/ BLANCHE
HANDLEBAR PAD YCF 50 WITHOUT CROSSBAR
BLACK/ PINK/ GREEN/ RED/ ORANGE/ BLUE/ YELLOW/ WHITE

→ YC50-0129 + COLOR

€ 8



MOUSSE GUIDON NOIRE/ ROSE/ VERTE/ ROUGE/ ORANGE/ BLEUE/ JAUNE/ BLANCHE
HANDLEBAR PAD BLACK/ PINK/ GREEN/ RED/ ORANGE/ BLUE/ YELLOW/ WHITE

→ YC110-0132 + COLOR

€ 8



PAIRE DE PROTÈGES MAINS
HANDGUARD

→ YC110-14-070BK (NOIRE/ BLACK)
→ YC110-14-070WH (BLANCHE/ WHITE)

€ 25



PAIRE DE PROTÈGES MAINS ENDURO/SUPERMOTO
(FIXATION POUR GUIDON ACIER/ALU Ø 22,2 ET 28,6)
ENDURO/SUPERMOTO HANDGUARDS
(FIXING KITS FOR STEEL/ALU Ø 22,2 AND 28,6)

→ YC110-14-071BK (NOIRE/ BLACK)
→ YC110-14-071WH (BLANCHE/ WHITE)

€ 59



PROTÈGE LEVIER TYPE MOTOGP
MOTOGP STYLE LEVER PROTECTION

→ YC110-14-072BK

€ 39

FACTORY
SPECIAL PARTS
YCF RACING



GUIDON ALUMINIUM (MOUSSE COMPRISE)
BLEU/ ROUGE/ ORANGE/ VERT/ NOIR
ALUMINIUM HANDLEBAR (BAR PAD INCLUDED)
BLUE/ BLACK/ RED/ ORANGE/ GREEN

→ GA + COLOR

€ 39

FACTORY
SPECIAL PARTS
YCF RACING



GUIDON ALUMINIUM SANS BARRE (POUR YCF 50) BLEU/ NOIR/ ROUGE/ ORANGE/ VERT/ (MOUSSE COMPRISE)
ALUMINIUM HANDLEBAR WITHOUT CROSSBAR (FOR YCF 50) BLUE/ BLACK/ RED/ ORANGE/ GREEN (BAR PAD INCLUDED)

01 → GASB50 + COLOR

€ 49

FACTORY
SPECIAL PARTS
YCF RACING



GUIDON MID SIZE ALUMINIUM (MOUSSE COMPRISE)
BLEU/ NOIR/ ROUGE/ ORANGE/ VERT
ALUMINIUM CROSS BAR (BAR PAD INCLUDED)
BLUE BLUE/ BLACK/ RED/ ORANGE/ GREEN

→ GALOW + COLOR

€ 39

GUIDON ALUMINIUM SANS BARRE BLEU/ NOIR/ ROUGE/ ORANGE/ VERT (MOUSSE COMPRISE)
ALUMINIUM HANDLEBAR WITHOUT CROSSBAR BLUE/ BLACK/ RED/ ORANGE/ GREEN (BAR PAD INCLUDED)

02 → GASB + COLOR

€ 59

02 →

01 →



04 →

03 →

GUIDON ACIER (POUR YCF 50)
STEEL HANDLEBAR (FOR YCF 50)

GUIDON CHROMOLLY
CHROMOLLY HANDLEBAR

01 → YC50-0101-02 (YCF 50)
02 → YC110-0101-01 (CHROMOLLY)
03 → YC110-0101-12 (CHROMOLLY BAS/ LOW: 665mm)
04 → YC110-0101-16-BK (BIGY: 780mm)

€ 15



GUIDON ALUMINIUM RENFORCÉ 28.6 mm
ALUMINIUM HANDLEBAR 28.6 mm

→ GA-02BK (FACTORY 760mm)

€ 79



POIGNÉES HANDLES



→ FOR 50 ONLY

**NEW
2021**



01 →

02 →

FACTORY
SPECIAL PARTS
YCF RACING

LEVIER DE FREIN AVANT OU ARRIÈRE PLIABLE POUR YCF 50 2020-21
NOIR/ BLEU/ ROUGE/ ORANGE/ VERT
FOLDABLE FRONT OR REAR BRAKE LEVER FOR YCF 50 2020-21
BLACK/ BLUE/ RED/ ORANGE/ GREEN

01 → LFG50-1 + COLOR (ARRIÈRE/ REAR) YCF50 2012-2019
02 → LFD50-1 + COLOR (AVANT/ FRONT) YCF50 2012-2019

€ 39



LEVIER D'EMBRAYAGE AVEC COCOTTE CNC NOIRE/ ROUGE/ BLEUE/ VERTE
CLUTCH LEVER WITH CNC BRACKET BLACK/ RED/ BLUE/ GREEN

→ YC110-0103-06 + COLOR

€ 129

FACTORY
SPECIAL PARTS
YCF RACING

**NEW
2021**



01 →

02 →

LEVIER DE FREIN OU D'EMBRAYAGE PLIABLE NOIR/ BLEU/ ROUGE/ ORANGE/ VERT
FOLDABLE BRAKE OR CLUTCH LEVER BLACK/ BLUE/ RED/ ORANGE/ GREEN

01 → LEP21+COLOR (EMBRAYAGE/ CLUTCH)
02 → LFP21 + COLOR (FREIN/ BRAKE)

€ 39

€ 39



01 →

02 →

LEVIER FREIN OU EMBRAYAGE REPLIABLE
VENDU AVEC LA COCOTTE

FOLDABLE BRAKE OR CLUTCH LEVER
SOLD WITH BRACKET

01 → LEPLIABLE (EMBRAYAGE/ CLUTCH)
02 → LFPLIABLE (FREIN/ BRAKE)

€ 25

€ 19



01 →

02 →

03 →

POIGNÉE DE GAZ À TIRAGE RAPIDE YCF (VENDU AVEC LES 2 POIGNÉES)

YCF QUICK-ACTION THROTTLE TUBE (INCLUDE GRIP)

01 → YC110-0138-03

€ 22

POIGNÉE DE GAZ AVEC RÉGLAGE (VIS DE BRIDAGE)
THROTTLE TUBE WITH ADJUSTMENT SCREW (POWER CONTROL)

02 → YC110-0138-04

€ 22

VIS M5X50 POUR RÉGLAGE DE LA POIGNÉE DE GAZ
SCREW FOR THROTTLE ADJUSTMENT, SIZE M5X50

03 → YC110-01022-06

€ 2



LEVIER FREIN PLIABLE
FOLDABLE BRAKE LEVER

→ YC110-0517-01

€ 15



LEVIER D'EMBRAYAGE + COCOTTE AVEC MOLETTE RAPIDE (2018-21)

CLUTCH LEVER + BRACKET WITH FAST WRENCH ADJUSTER (2018-21)

→ YC110-0135-02

€ 19



EMBOUIT PLASTIQUE DE GUIDON
BAR END CAPS

→ YC110-0153-01

€ 1



LEVIER FREIN COMPLET AVEC COCOTTE POUR YCF 50
BRAKE LEVER COMPLETE WITH BRACKET FOR YCF 50

→ YC50-0501 (AVANT/ FRONT) (YCF 50 2012-19)

€ 10



COCOTTE D'EMBRAYAGE
CLUTCH BRACKET

01 → YC110-0134-04 (2018-21)

€ 15

02 → YC110-0126-01 (YCF 2005-17)

€ 12

CAOUTCHOUC DE LEVIER FREIN & EMBRAYAGE
RUBBER BRAKE & CLUTCH LEVERS

09 → YC110-0502-01 (FREIN/ BRAKE)

€ 3

10 → YC110-0103-10 (EMBRAYAGE/ CLUTCH)

LEVIERS FREIN & EMBRAYAGE
BRAKE & CLUTCH LEVERS

04 → YC110-0103-07 (EMBR./ CLUTCH) (PILOT/ SM/ FACTORY/ BIGY 2018-21)

€ 8

05 → YC110-0501-014 (FREIN/ BRAKE) (2005-17)

06 → YC110-0103-03 (EMBR./ CLUTCH) (2005-17)

→ YC50-0503-05 (FREIN AVANT/ FRONT BRAKE) (YCF 50 2020-21)

08 → YC50-0503-06 (FREIN ARRIÈRE/ REAR BRAKE) (YCF 50 2020-21)

€ 8

LEVIER FREIN RÉGLABLE POUR KIT FREIN 4 PISTONS
ADJUSTABLE BRAKE LEVER FOR 4 PISTONS BRAKE KIT

03 → YC110-0501-012

€ 8

SPECIAL PARTS
YCF RACING



POIGNÉES CAOUTCHOUC YCF (X2)
GRISE/ ROSE/ ROUGE/ BLEUE/ BLANCHE/ JAUNE/ VERTE/ NOIRE/ ORANGE

YCF RUBBER GRIPS (X2) GREY/ PINK/ RED/ BLUE/ WHITE/ YELLOW/ GREEN/ BLACK/ ORANGE

→ PPC011 + COLOR

€ 10



DONUTS (X2) ROUGE/ JAUNE/ VERT/ ORANGE/ NOIR

GRIP DONUTS (X2) RED/ YELLOW/ GREEN/ ORANGE/ BLACK

→ DONUTZ-02 + COLOR

€ 4



CÂBLE EMBRAYAGE
CLUTCH CABLE

01 → YC110-0107 L=900mm A+B=93mm (SM125 2021/ SM190 2021)

01 → YC110-0108 L=900mm A+B=65mm (SP1/ SM150)

01 → YC110-0109-21 L=1000mm A+B=105mm (PILOT 150/ BIGY MX150)

01 → YC110-0109-22 L=1000mm A+B=93mm (SP3 190/ BIGY 190)

02 → YC110-0109-20 L=950mm A+B=75mm (LITE 125/ START 125/ BIGY 125MX)

02 → YC110-0109-23 L=920mm A+B=75mm (SP2)

€ 11

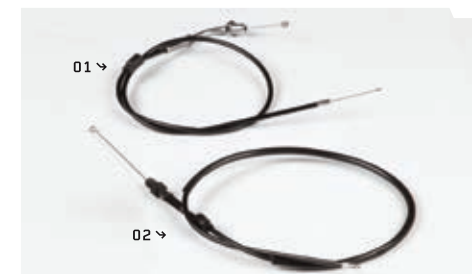

CÂBLE DE GAZ
THROTTLE CABLE

01 → CGCOUDEE (CURVED OUTLET/ COUDÉ)

€ 12

02 → YC110-0106 (ALL RANGE EXCEPT YCF50)

02 → YC50-0106-14 (FOR 50 ONLY)

02 → YC110-0106-12 (BIGY)

€ 11

FOURCHES FORKS



**KIT RÉFÉCTION FOURCHE TAILLE 33/46/11 : 1 JOINT SPY/ 1 CACHE POUSSIÈRE/
1 BAGUE INF/ 1 BAGUE SUP**
FORK REPAIR KIT SIZE 33/46/11 INCLUDING: 1 FORK OIL SEAL/ 1 DUST COVER/
1 LOWER RING/ 1 UPPER RING

→ YC110-0470

€ 19

JOINT SPY FOURCHE
FORK OIL SEAL

01 → YC50-0415 (POUR/ FOR 50 - 25X25X10)
01 → YC110-0440 (33*46*11) START/ PILOT/ FACTORY/ BIGY

€ 8



TÉ FOURCHE COMPLET 170MM SP3 48/48
TRIPLE CLAMP SET 48/48 170MM SP3

01 → YC110-0225-05-GY

€ 199



JEU TUBE FOURCHE RÉGLABLE
ADJUSTABLE FORK

→ YC110-0400-10 (735mm)
→ YC110-0400-35 (800mm)

€ 349



JEU TUBE FOURCHE UPSD NON RÉGLABLE
UPSD FORK

→ YC110-0400-43 (600mm)
→ YC110-0400-41 (660mm)
→ YC110-0400-40 (735mm)
→ YC110-0400-33 (800mm)

€ 199



BOUCHON PURGE DE FOURCHE Ø 5mm
NOIR/ BLEU/ ROUGE/ VERT/ ORANGE
FORK AIR BLEEDER Ø 5mm
BLACK/ BLUE/ RED/ GREEN/ ORANGE

→ BPF1 + COLOR

€ 19



TÉ FOURCHE COMPLET 160mm 48/45 OU 48/48 (ROUGE/ ORANGE/ BLEU/ VERT/ NOIR)
TRIPLE CLAMP SET 160mm 48/45 OR 48/48 (RED/ ORANGE/ BLUE/ GREEN/ BLACK)

- YC110-02-053 + COLOR (48/45)
- YC110-02-049 + COLOR (48/48)

c 199

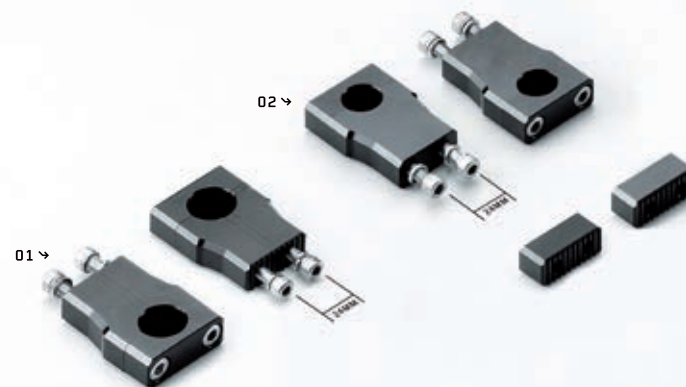

JEU DE PONTETS GUIDON YCF 2012-2019
BAR MOUNTS FOR YCF 2012-2019

- 01 → YC110-0203-12 (LITE/ START/ PILOT/ SM/ BIGY MX) Ø 22,2
- 02 → YC110-0203-08 (SP3 2016-19/ BIGY 190 DAYTONA 2017-19) Ø 28,6

€ 49



JEU DE PONTETS GUIDON YCF 2020-21
BAR MOUNT FOR YCF 2020-21

- 04 → YC110-0203-038 (FACTORY SP3/ BIGY 190 DAYTONA) Ø 28,6
- 05 → YC110-0203-035 (50/ LITE/ START/ PILOT/ SP2/ BIGY MX) Ø 22,2

€ 59
€ 49



ÉCROU POUR COLONNE DE DIRECTION
STREERING STEM NUT

01 → YC110-02-09 (NOTCHED/ CRANTÉ)
02 → YC110-02-11 (SUPÉRIEUR/ UPPER)

€ 5



JOINT POUR COLONNE DE DIRECTION ADAPTABLE
SUR START/ PILOT/ FACTORY/ SM/ BIGY

SEAL FOR STEERING STEM ADAPTABLE ON START/
PILOT/ FACTORY/ SM/ BIGY

→ YC110-02-20

€ 3



JEU DE ROULEMENT COLONNE DIRECTION

TAPER ROLLER BEARING FOR STEERING STEM

→ KRIRECTION41, AFTERMARKET (INFÉRIEUR Ø EXT 41 - INT 23,5mm/ SUPÉRIEUR Ø EXT 41 - INT 22,5mm) €
→ KRIRECTION41-2, YCF50 2012-19 - START 88 2008-19 - LITE88/125 2016-19
(INFÉRIEUR Ø EXT 41 - INT 24mm/ SUPÉRIEUR Ø EXT 41 - INT 22,5mm)
→ KRIRECTION46, ALL START 125 - PILOT - FACTORY - BIGY and 50A-E 2020-21 - START 88SE 2020-21
LITE 88-125 2020-21 (INFÉRIEUR Ø EXT 46 - INT 23,5mm/ SUPÉRIEUR Ø EXT 46 - INT 22mm)

€ 39



ÉCROU POUR COLONNE DE DIRECTION NOIR/ BLEU/ ROUGE/ VERT/ ORANGE
STREERING STEM NUT BLACK/ BLUE/ RED/ GREEN/ ORANGE

→ ECD + COLOR

€ 12



CADRES FRAMES



BÉQUILLE
STAND

01 → YC110-0904-01 (RÉGLABLE 250mm to 350mm) € 19
01 → YC110-0904-05 (BIGY) € 19

RESSORT DE BÉQUILLE
STAND'S SPRING

02 → YC110-19-01 € 2

VIS ET ÉCROU BÉQUILLE
STAND SCREW & NUT

03 → GB6170-M10-G (ÉCROU/ NUT) € 2
04 → FB02-M10x1,5x30I (VIS/ SCREW) € 2

KIT VIS RENFORCÉE POUR MOTEUR
ENGINE REINFORCED SCREW SET

05 → KITVIS8 (Ø 8) € 8
05 → KITVIS10 (Ø 10) € 8

PATTE DE CADRE
FRAME STEEL PADS

→ YC110-16-061BK (START F125) € 19
→ YC110-16-067BK (PILOT 2013) € 19
→ YC110-1622-02BK (PILOT 2014-2020) € 19
→ YC110-1622-03 (BIGY - SUNDAY) € 49

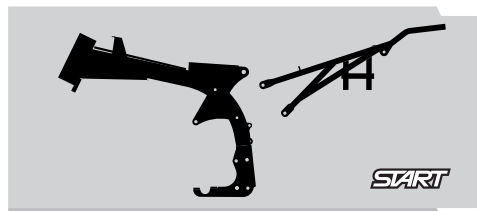

CADRE BLANC RENFORCÉ 88 POUR BRAS MONO
(BOUCLE ARRIÈRE INCLUSE)
88 REINFORCED WHITE FRAME FOR MONO SWING ARM
(REAR SUBFRAME INCLUDED)

→ YC88-161-0301-WH (START SE88) € 149



BOUCLE ARRIÈRE 88
88 REAR SUBFRAME

→ YC88-16-020 (START F88S) € 59
→ YC88-16-022-BK (START F88SE) € 59



CADRE RENFORCÉ LITE POUR BRAS CANTILEVER
(BOUCLE ARRIÈRE INCLUSE)
LITE YCF REINFORCED FRAME FOR CANTILEVER
SWING ARM (REAR SUBFRAME INCLUDED)

→ YC110-161-0301-WH (LITE88) € 179
→ YC110-161-0401-WH (LITE 125/ 150) € 179

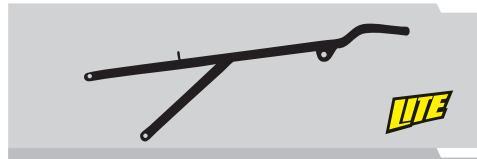

BOUCLE ARRIÈRE LITE
LITE REAR SUBFRAME

→ YC110-1614-13-BK (LITE F88) € 59
→ YC110-1614-24-BK (LITE F125/ F150) € 59

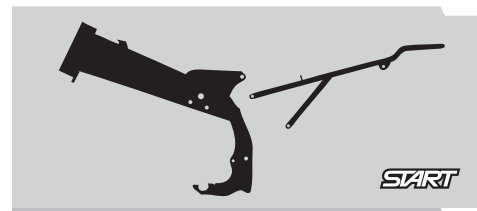

CADRE R START BLANC POUR BRAS MONO
ET AMORTISSEUR 270mm (BOUCLE AR. INCLUSE)
R START WHITE FRAME FOR MONO SWING ARM AND
SHOCK ABSORBER 270mm (REAR SUBFRAME INCL.)

→ YC110-166-0201-WH (START 125S) € 169



BOUCLE ARRIÈRE START 125
START 125 REAR SUBFRAME PART

→ YC110-16-070BK € 59



CADRE COMPLET PILOT 125 & 150 2018-20
(AXE BRAS Ø 15) (BOUCLE ARRIÈRE INCLUSE)
2018-20 PILOT 125 & 150 COMPLET FRAME (ARM AXLE Ø
15) (REAR SUBFRAME INCLUDED)

→ YC110-1621-0301-WH (BLANC/WHITE) (axe 15) € 239
→ YC110-1601-0301-BK (NOIR/BLACK) (axe 15) € 239



BOUCLE ARRIÈRE PILOT
PILOT REAR SUBFRAME

→ YC110-1614-26-BK (2016-21) € 79



CADRE YCF 2019-2021 FACTORY (BOUCLE AR. INCLUSE)
2019-21 FACTORY YCF FRAME (REAR SUBFRAME INCL.)

→ YC110-1621-0801-BK (CADRE 22° 2019-21) € 299



BOUCLE ARRIÈRE FACTORY
FACTORY REAR SUBFRAME

→ YC110-1614-15-BK (2016-21 ACIER/ STEEL) € 79
→ YC110-1614-18 (2016-21 ALUMINIUM) € 79



CADRE YCF 2018-21 BIGY (AXE BRAS Ø 15) (BOUCLE
ARRIÈRE INCLUSE)
2018-21 BIGY YCF FRAME (ARM AXLE Ø 15) (REAR SUBFRAME
INCLUDED)

→ YC110-1621-0201-BK (COMPLET) € 299



BOUCLE ARRIÈRE BIGY
BIGY REAR SUBFRAME

→ YC110-1614-08-BK (ACIER/ STEEL) € 99
→ YC110-1614-09-BK (190ZE) € 109

SELLES & HOUSSES SEATS & COVERS

FACTORY
SPECIAL PARTS
YCF RACING



SELLE COMPLÈTE ANTI DÉRAPANTE RENFORCÉE BLEUE/ ROUGE/ VERTE/ JAUNE/ ORANGE
COMPLETE NON-SLIP REINFORCED SEAT BLUE/ RED/ GREEN/ YELLOW/ ORANGE

→ YC110-1401-12 + COLOR (BIGY)

€ 89

FACTORY
SPECIAL PARTS
YCF RACING



SELLE COMPLÈTE ANTI DÉRAPANTE RENFORCÉE BLEUE/ ROUGE/ VERTE/ JAUNE/ ORANGE
COMPLETE NON-SLIP REINFORCED SEAT BLUE/ RED/ GREEN/ YELLOW/ ORANGE

→ YC110-1401-08 + COLOR (LITE 2016-21, START 2009-21, PILOT 125 2013-14)
→ YC110-1401-07 + COLOR (PILOT 125 2015-21, PILOT 150, FACTORY, SM 150)

€ 59

€ 79



SELLE YCF POUR BIGY
YCF SEAT FOR BIGY

→ YC110-1401-11

€ 79

FACTORY
SPECIAL PARTS
YCF RACING



SELLE YCF LONGUE PILOT 125 2015-21/ PILOT 150 2013-21/ FACTORY 2012-21/ SM 150 2013-21/ SM 190 2021

YCF LONG SEAT PILOT 125 2015-21/ PILOT 150 2013-21/ FACTORY 2012-21/ SM 150 2013-21/ SM 190 2021

→ YC110-1401-17

€ 69



→ FOR 50 ONLY

01 →



02 →



SELLE YCF 50
YCF 50 SEAT

01 → YC50-1401-05

€ 49

02 → YC50-1401-03 (HAUTE/ HIGH + 4 cm)

€ 55



SELLE LITE 2016-21/ START 2009-21/ PILOT 125 2013-14

SEAT LITE 2016-21/ START 2009-21/ PILOT 125 2013-14

→ YC110-1401-10

€ 49



SELLE BASSE YCF POUR LITE 2016-21/ START 2009-21/ PILOT 125 2013-14

YCF LOW SEAT FOR LITE 2016-21/ START 2009-21/ PILOT 125 2013-14

→ YC110-14013

€ 49



→ FOR 50 ONLY



SELLE COMPLÈTE ANTI DÉRAPANTE RENFORCÉE BLEUE/ ROUGE/ VERTE/ JAUNE/ ORANGE
COMPLETE NON-SLIP REINFORCED SEAT BLUE/ RED/ GREEN/ YELLOW/ ORANGE

→ YC50-1401+ COLOR (50 SEULEMENT/ ONLY)

€ 59

RÉSERVOIRS FUEL TANKS



RÉSERVOIR ET COUVRE RÉSERVOIR YCF POUR BIGY
YCF FUEL TANK AND TANK COVER FOR BIGY

01 → YC110-0701-04
02 → YC110-0719-01

€ 59
€ 15



RÉSERVOIR YCF (ADAPTABLE SUR TOUTES LES ANCIENNES YCF ET SUR LES MINIS AVEC RÉSERVOIR TYPE CRF 50)
YCF FUEL TANK (CAN BE ADAPTED TO ALL PREVIOUS YCF AND TO MINI-BIKES WITH A TYPE CRF 50 FUEL TANK)

→ YC110-0701-01

€ 39



RÉSERVOIR POUR YCF 50
FUEL TANK FOR YCF 50

→ YC50-07012

€ 39



BOUCHON RÉSERVOIR ALUMINIUM YCF NOIR/ ROUGE/ ORANGE/ VERT/ BLEU
YCF ALUMINIUM GAS CAP BLACK/ RED/ ORANGE/ GREEN/ BLUE

→ BOUCHONALU+ COLOR

€ 35



VALVE PRISE AIR BLEUE/ NOIRE/ ROUGE/ ORANGE/ VERTE
FUEL VENT VALVE BLUE/ BLACK/ RED/ ORANGE/ GREEN

→ YC125-0704 + COLOR

€ 9



DURITE ESSENCE ROUGE/ ORANGE/ BLEUE/ VERTE/ JAUNE/ ROSE

FUEL LINE RED/ ORANGE/ BLUE/ GREEN/ YELLOW/ PINK

→ DC + COLOR

€ 6



01 →

02 →

ROBINET ESSENCE
FUEL PETCOCK

02 → YC110-0703 (1 EXIT FOR YCF/ 1 SORTIE POUR YCF)
01 → 13020100 (2 EXITS/ 2 SORTIES)

€ 25

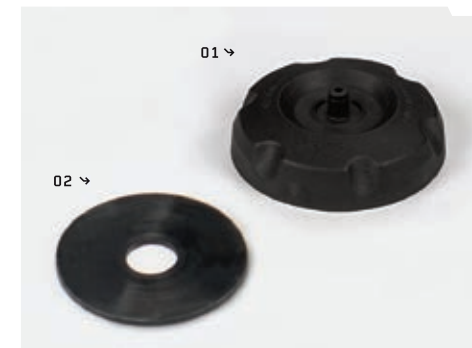

01 →

02 →

BOUCHON ET JOINT RÉSERVOIR PLASTIQUE
GAS CAP AND SEAL

01 → YC110-0702-01 (YCF ORIGINAL DESIGN)

02 → YC110-0720-02

€ 13

€ 2

FREINS BRAKES



PATTE DE FREIN CNC POUR ÉTRIER RADIAL
CNC ALUMINIUM BRACKET FOR RADIAL BRAKE CALIPER

01 → YC110-0510-06-SI (AV./FR. FOR DISK 220 MM)
01 → YC110-0510-07-SI (AV./FR. FOR DISK 240 MM)
02 → YC110-1210-06-SI (ARR./ REAR) **€ 39**

**RESSORT ANTI VIBRATION
POUR ÉTRIER RADIAL ARRIÈRE**
REAR SPRING ANTI VIBRATION
FOR REAR CNC RADIAL BRAKE

03 → YC110-1256-02 **€ 5**

**RESSORT PLAQUETTE DE FREIN
POUR ÉTRIER RADIAL AVANT**
BRAKE PADS SPRING FOR FRONT CNC RADIAL BRAKE

04 → YC110-0556-02 **€ 5**

AXE DE PLAQUETTE DE FREIN POUR ÉTRIER RADIAL
BRAKE PADS AXLE FOR CNC RADIAL BRAKE

05 → YC110-0555-02 (AVANT/ FRONT) **€ 4**
06 → YC110-1255-02 (ARRIÈRE/ REAR) **€ 4**



KIT FREIN AVANT RADIAL
RADIAL FRONT BRAKE KIT

→ YC110-05012-09BK **€ 149**



KIT FREIN ARRIÈRE RADIAL
RADIAL REAR BRAKE ASSEMBLY

→ YC110-12012-0BK **€ 149**



MAÎTRE CYLINDRE FREIN AVANT SUPERMOTARD
SUPERMOTARD FRONT BRAKE MASTER CYLINDER

→ YC110-0507-01 **€ 99**



LEVIER FREIN SEUL POUR MAÎTRE CYLINDRE FREIN AVANT SM
SM BRAKE LEVER FOR FRONT BRAKE MASTER CYLINDER

→ YC110-0503-02 **€ 19**



ÉTRIER FREIN CNC RADIAL FACTORY
FACTORY BRAKE CALIPER RADIAL CNC

01 → YC110-1201-06-BK (ARRIÈRE/ REAR) **€ 115**
02 → YC110-0502-06-BK (AVANT/ FRONT)



KIT FREIN AVANT FACTORY (LEVIER RÉGLABLE) 2016-21
FACTORY FRONT BRAKE KIT (ADJUSTABLE LEVER) 2016-21

→ YC110-0501-3101 (SP2/ SP3/ BIGY)

€ 95



KIT FREIN ARRIÈRE FACTORY 2016-2021
FACTORY REAR BRAKE ASSEMBLY 2016-2021

→ YC110-12012-2601 (SP2/ SP3)
 → YC110-12012-2801 (BIGY FACTORY)

€ 95



KIT FREIN ARRIÈRE HYDRAULIQUE YCF 50 2020-21 (ADAPTABLE SUR LES YCF 50 2012-2019)
HYDRAULIC REAR BRAKE KIT YCF 50 2020-21 (CAN FIT ON YCF 50 2012-2019)

→ YC50-1214-03

€ 79



KIT FREIN AVANT HYDRAULIQUE YCF 50 2020-21 (ADAPTABLE SUR LES YCF 50 2012-2019)
HYDRAULIC FRONT BRAKE KIT YCF 50 2020-21 (can fit on YCF 50 2012-2019)

→ YC50-0511-03

€ 79





ÉTRIER FREIN AVANT
FRONT BRAKE CALIPER

- 01 → YC110-0501-0205 (DOUBLE PISTON) € 59
- 02 → YC110-0501-0203 (4 PISTONS) € 59
- 03 → YC50-0502 (YCF 50) € 39
- 08 → YC110-0501-0207 (SP3 2016-21) € 69

MAITRE CYLINDRE AVANT
FRONT BRAKE MASTER CYLINDER

- 04 → YC110-0501-0103 (FREINAGE À GAUCHE) € 49
- 04 → YC110-0501-0102 (DOUBLE PISTON) € 49
- 05 → YC110-0501-0101 (4 PISTONS) € 49
- 07 → YC110-0501-0104-01 (PILOT/ FACTORY 2016-21) € 59

DURITE FREIN AVANT
FRONT BRAKE HOSE

- 06 → YC110-0501-0325 (FILETAGE AU MAÎTRE CYLINDRE) € 29
- 06 → YC110-0501-0327 (BANJO AU MAÎTRE CYLINDRE/ BIGY)



KIT FREIN COMPLET AVANT AVEC ÉTRIER DOUBLE PISTON
COMPLETE FRONT BRAKE KIT WITH DOUBLE PISTON CALIPER

- YC110-0501-1801 (LITE F125/F150, START F125, SP)
- YC110-0501-3301 (BIGY/ PILOT/ SM F150)

€ 75



KIT FREIN AVANT COMPLET START F88 2010/2019
COMPLETE FRONT BRAKE KIT START F88 2010/2019

- YC110-0501-2001

€ 75



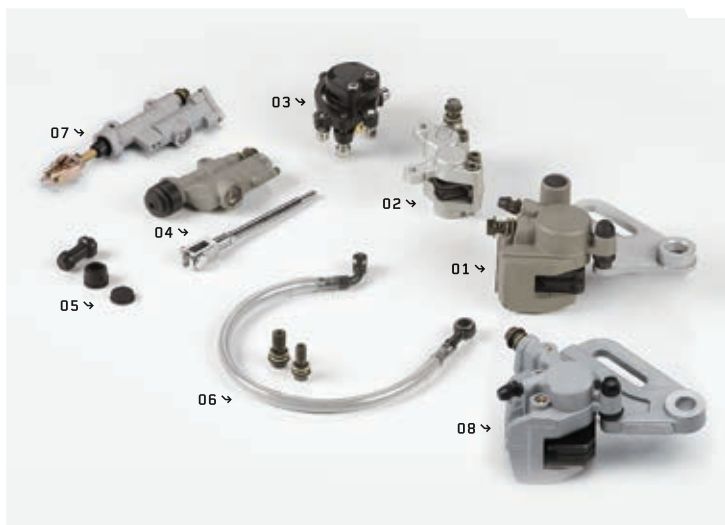

ÉTRIER FREIN ARRIÈRE
REAR BRAKE CALIPER

- 01 → YC110-1201-0401 (1 PISTON) € 59
- 02 → YC110-0501-0203 (4 PISTONS) € 39
- 03 → YC50-1201 (YCF 50) € 39
- 08 → YC110-1201-07 (SP3 2016-21) € 69

MAÎTRE CYLINDRE FREIN ARRIÈRE
REAR BRAKE MASTER CYLINDER

- 04 → YC110-1201021 (Ø 8/ DIST. 40mm) € 30
- YC110-1201023 (Ø 10/ DIST. 40mm) € 30
- 07 → YC110-1201025 (Ø 10/ DIST. 53mm) € 39
- YC110-1201026 (Ø 10/ LITE) € 30

JEU DE CAOUTCHOUCS ÉTRIER FREIN ARRIÈRE
SET OF REAR BRAKE CALIPER RUBBER

- 05 → YC110-120110 € 5

DURITE FREIN ARRIÈRE Ø 10 ÉTRIER
REAR BRAKE HOSE CONNECTION Ø 10 CALIPER

- 06 → YC110-1201045 (Ø 8 MASTER CYLINDER) 370mm
- 06 → YC110-1201041 (Ø 8 MASTER CYLINDER) 465mm
- 06 → YC110-1201038 (Ø 10/ LITE) 410mm
- 06 → YC110-1201048 (Ø 10/ PILOT/ SP1 2016-21) 465mm
- 06 → YC110-1201050 (Ø 10/ SP2/ SP3 2016-21) 465mm
- 06 → YC110-1201049 (Ø 10/ BIGY) 515mm € 19



KIT FREIN COMPLET ARRIÈRE 1 PISTON
COMPLETE REAR BRAKE ASSEMBLY

- YC110-12012-0601 (START) € 75
- YC110-12012-3101 (LITE) € 75
- YC110-12012-2701 (BIGY) € 75
- YC110-12013-0301 (360 mm START 88SE 2020-21) € 75
- YC110-12012-2401 (PILOT/ SM F150) € 75



MAÎTRE CYLINDRE AVEC BOCAL
MASTER CYLINDER WITH BOWL

- YC110-120102 € 39





FACTORY

PÉDALE DE FREIN FACTORY AVEC ROULEMENT
FACTORY BRAKE PEDAL WITH BEARING

→ YC110-219-03

€ 39



**NEW
2021**

FACTORY

PÉDALE FREIN FACTORY AVEC ROULEMENT NOIR
BLACK FACTORY BRAKE PEDAL WITH BEARING

→ YC110-219-03-BK

€ 49



**NEW
2021**

**EMBOUT PEDALE FREIN ALUMINIUM BLEU/ ROUGE/
NOIR/ ORANGE/ VERT**

COLOR REAR BRAKE LEVER TIPS BLUE/ RED/ BLACK/
ORANGE/ GREEN

→ YC110-1223-02-COLOR

€ 14



**PROTECTION MAÎTRE CYLINDRE FREIN ARRIÈRE
POUR LITE/ START 2007-21/ PILOT/ FACTORY 2007-15**
REAR BRAKE MASTER CYLINDER GUARD
FOR LITE/ START 2007-21/ PILOT/ FACTORY 2007-15

→ YC110-1224

€ 12



START

PÉDALE FREIN ALUMINIUM POUR 88/125 START
ALUMINIUM BRAKE PEDAL FOR 88/125 START

→ YC110-218

€ 39



START

PÉDALE FREIN ACIER POUR START 88/125
STEEL BRAKE PEDAL FOR 88/125 START

→ YC110-211

€ 25



PÉDALE DE FREIN ACIER
STEEL BRAKE PEDAL

→ YC110-217 (R-START/ PILOT 140 2010-11-12)

→ YC110-217-02 (PILOT/ SM150 2013-21)

€ 25



→ FOR 50 ONLY



KIT PÉDALE FREIN AU PIED POUR YCF 50 2012-19
BRAKE PEDAL KIT FOR YCF 50 2012-19

→ YC50-1219

€ 59



**PÉDALE DE FREIN ALUMINIUM HAUT DE GAMME
2010-2011-CLASSIC 2012**
ALUMINIUM BRAKE PEDAL HIGH-RANGE
2010-2011-CLASSIC 2012

→ YC110-215

€ 39



**CHAPE MAÎTRE CYLINDRE FREIN ARRIÈRE CNC
BLEU/ NOIR/ ROUGE/ ORANGE/ VERT**
CNC REAR BRAKE CLEVIS BLUE/ BLACK/ RED/
ORANGE/ GREEN

→ EMC + COLOR

→ EMC01 + COLOR (PILOT/ FACTORY/ BIGY 2016-21)

€ 15



EMBOUT PÉDALE FREIN
REAR BRAKE LEVER TIPS

01 → YC110-1223-01 (ACIER/ STEEL)

€ 6

02 → YC110-1223-02 (ALUMINIUM)

€ 12

**CÂBLE DE PÉDALE DE FREIN ARRIÈRE AVEC GAINÉ
(POUR ÉVITER DE TORDRE LA PÉDALE DE FREIN)**
REAR BRAKE PEDAL CABLE WITH SHEATH
(TO AVOID BRAKE PEDAL TWISTING)

03 → YC110-1260-01

€ 6

RESSORT PÉDALE FREIN
BRAKE PEDAL SPRING

04 → YC110-21-01 (ACIER/ STEEL)

04 → YC110-21-05 (ALUMINIUM)

04 → YC110-21-06 (ALUMINIUM FACTORY)

€ 6



- 01 ↘ PPC011-WH
- 02 ↘ LFP21-BK
- 03 ↘ DONUTZ-02-GR
- 04 ↘ YC110-0103-06-GR
- 05 ↘ DC-GR
- 06 ↘ BOUCHOUALU-BK
- 07 ↘ KD-BIGYMONSTER-17
- 08 ↘ YC110-140-02-BK
- 09 ↘ YC110-2303
- 10 ↘ YC110-0404-69
- 11 ↘ RPALU-GR
- 12 ↘ TC12-GR



DISQUE DE FREIN ENTRAXE 102,5mm Ø INT. 76mm
BRAKE DISC CENTRE TO CENTRE DISTANCE 102,5mm
INNER Ø 76mm

- YC110-0513-02 (AVANT/ FRONT 220mm) € 35
- YC110-1115-01 (ARRIÈRE/ REAR 200mm) € 35



KIT VIS INOX POUR DISQUE DE FREIN
INOX BOLT KIT FOR BRAKE DISC

- KVD € 3



DISQUE DE FREIN AVANT 240mm AVEC PATTE DE DÉPORT
240mm FRONT BRAKE DISC WITH LEG OFFSET

- KS2 € 49

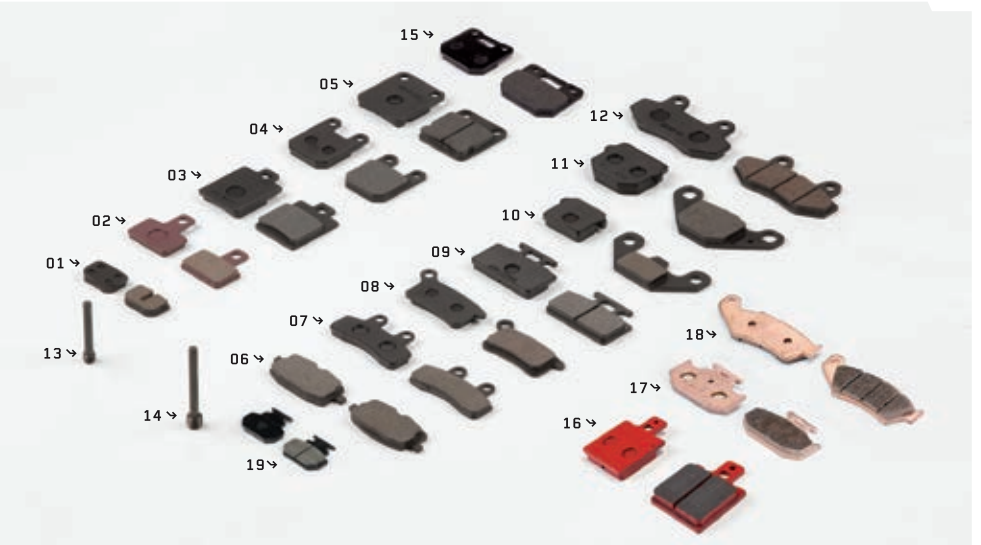

JEU DE PLAQUETTES FREIN AV. & AR. POUR YCF 50
SET OF BRAKE PADS FRONT & REAR FOR YCF 50

- 01 → YC50-0506 (2012-2019) € 15
- 19 → YC50-0506-02 (YCF 50 2020-21 HYDRAULIQUE) € 16

JEU DE PLAQUETTES FREIN ARRIÈRE
REAR BRAKE PADS

- 02 → YC110-120107
- 03 → YC110-120108
- 04 → 14030213/4N (YCF 2005)
- 17 → YC110-1204-02 (SP 2016-21/ BIGY/ FACTORY 2017-20) € 16

JEU DE PLAQUETTES FREIN AR. 1 PISTON YCF
REAR BRAKE PADS SINGLE 1 PISTON YCF

- 05 → YC110-120104 (START 2012-21/ LITE 2016-20) € 16

JEU DE PLAQUETTES FREIN AVANT YCF 2005
FRONT BRAKE PADS YCF 2005

- 06 → 14010114/5 € 16

JEU DE PLAQUETTES FREIN AVANT/ARRIÈRE POUR ÉTRIER 4 PISTONS POUR YCF 2007 ET 88 2009-11
BRAKE PADS FRONT/REAR FOR 4 PISTONS CALIPER FOR YCF 2007 AND 88 2009-11

- 08 → YC110-0501-0401 € 16

JEU DE PLAQUETTES FREIN AVANT
FRONT BRAKE PADS

- 07 → YC110-0501-0405
- 09 → YC110-0501-0404
- 10 → YC110-0501-0406
- 18 → YC110-0501-0416 (SP 2016-21/ BIGY/ FACTORY 2017-20) € 16

JEU DE PLAQUETTES SIMPLE PISTON POUR YCF 2006
BRAKE PADS SINGLE PISTON FOR YCF 2006

- 11 → YC110-0501-0402 € 16

JEU DE PLAQUETTES FREIN AVANT YCF 2008-13
FRONT BRAKE PADS YCF 2008-13

- 12 → YC110-0501-0403 € 16

VIS PLAQUETTE FREIN AVANT OU ARRIÈRE
FRONT OR REAR BRAKE PADS SCREW

- 13 → YC110-1255 (ARRIÈRE/ REAR)
- 14 → YC110-0555 (AVANT/ FRONT) € 2

JEU DE PLAQUETTES FREIN RADIAL AV. & AR.
SET OF RADIAL BRAKE PADS FRONT & REAR

- 15 → YC110-0506-01 (AVANT/ FRONT)
- 16 → YC110-1204-01 (ARRIÈRE/ REAR) € 16

NEW 2021



DISQUE FREIN AVANT FLOTTANT 220mm
SEMI FLOATING BRAKE ROTOR

- YC110-0613-01-BK € 99

NEW 2021



DISQUE DE FREIN AVANT FLOTTANT 240mm AVEC PATTES DE DÉPORT
240mm SEMI FLOATING BRAKE ROTOR WITH CALIPER MOUNTING BRACKETS KIT

- KS2-1 € 129



FACTORY
SPECIAL PARTS
YCF RACING

CAPOT MAÎTRE CYLINDRE FREIN AVANT CNC
BLEU/ NOIR/ ROUGE/ ORANGE/ VERT
FRONT BRAKE RESERVOIR COVER BLUE/ BLACK/ RED/ ORANGE/ GREEN

→ FBRC + COLOR (ALL YCF MODELS EXCEPT PILOT/ FACTORY 2016-2021)
→ FBRC01 + COLOR (PILOT/ FACTORY/ BIGY 2016-21)

€ 15



FACTORY
SPECIAL PARTS
YCF RACING

CAPOT MAÎTRE CYLINDRE FREIN ARRIÈRE CNC
BLEU/ NOIR/ ROUGE/ ORANGE/ VERT
REAR BRAKE RESERVOIR COVER BLUE/ BLACK/ RED/ ORANGE/ GREEN

→ RBRC + COLOR (ALL YCF MODELS EXCEPT PILOT/ FACTORY 2016-2021)
→ RBRC01 + COLOR (PILOT/ FACTORY/ BIGY 2016-21)

€ 12

BRAS OSCILLANTS SWING ARMS



**NEW
2021**

DIABOLO CNC NOIR/ BLEU/ ROUGE / VERT/ ORANGE
CNC REAR SPOOL BLACK/ BLUE/ RED/ GREEN/ ORANGE

→ KRS-COLOR

€ 19



FACTORY
SPECIAL PARTS
YCF RACING

BRAS OSCILLANT MONO ALU RENFORCÉ
ALUMINIUM REINFORCED MONO SWING ARM

- YC110-10015-01 (420mm POUR/ FOR SP2 2014-2021/ SP3 2014-21)
- YC110-1001-2101 (460mm POUR/ FOR SP3 2019-21)
- YC110-1001-10 (460mm, AXE 12 POUR/ FOR BIGY 2017)
- YC110-1001-1601 (460mm, AXE 15 POUR/ FOR BIGY 2018-21)

€ 249



START

BRAS OSCILLANT MONO CHROMOLY START
START MONO CHROMOLY SWING ARM

- YC110-1001-0701 (350mm)
- YC110-10014-01 (390mm)

€ 99



BRAS OSCILLANT MONO CHROMOLY
CHROMOLY MONO SWING ARM

- YC110-1001-05 (420mm, AXE 12 POUR/ FOR PILOT 2015-17)
- YC110-1001-1701 (420mm, AXE 15 POUR/ FOR PILOT 2018-21)
- YC110-1001-09 (460mm, AXE 12 POUR/ FOR BIGY 2017)
- YC110-1001-1501 (460mm, AXE 15 POUR/ FOR BIGY 2018-21)
- YC110-1001-08 (420mm, AXE 12 POUR SPI)

€ 149



LITE

BRAS OSCILLANT CANTILEVER LITE
LITE CANTILEVER SWING ARM

- YC110-1001-1201

€ 99



PROTÈGE DISQUE ARRIÈRE RENFORCÉ NYLON
REINFORCED NYLON REAR DISC GUARD

→ YC110-1024-04

€ 29



PROTÈGE DISQUE ARRIÈRE
REAR DISC GUARD

→ YC110-1010

€ 15



VIS ET ÉCROU TENDEUR DE CHAÎNE
BOLT AND NUT FOR BLOCK AXLE

01 → GB5783-M8X40-W (VIS/ SCREW)
02 → FB6170-M8-W (ÉCROU/ NUT)

€ 3

€ 2



AXE BRAS OSCILLANT
AXLE SWING ARM

01 → YC110-10-03 (Ø 10/ L: 185mm)
02 → YC110-10-034 (Ø 10/ L: 192mm)
02 → YC110-10-033 (Ø 12/ L: 236mm: FACTORY 2012-21)
02 → YC110-10-035 (Ø 12/ L: 240mm: PILOT)
04 → YC110-1009-01 (Ø 15: PILOT/ BIGY 2018-21)

€ 6

ROULEMENT BRAS OSCILLANT
SWING ARM BEARING

03 → 6200/30-10 (Ø EXT, 30/ Ø INT, 10)
03 → 6001/28-10 (Ø EXT, 28/ Ø INT, 10)
03 → 6001/28-12-08 (Ø EXT, 28/ Ø INT, 12)
03 → 6001/28-15-08 (Ø EXT, 28/ Ø INT, 15) (PILOT/ BIGY 2018-21)

€ 6

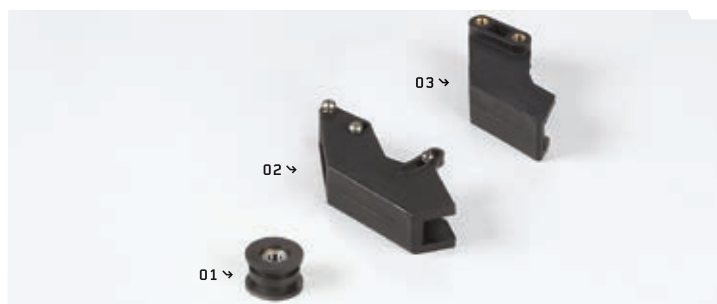

ROULETTE CHAÎNE
CHAIN TENSIONER

01 → YC110-2201-02
01 → YC50-2201-02 (50E-W88)
01 → YC110-2201-03 (SP3)

€ 12

GUIDE CHAÎNE ARRIÈRE
REAR CHAIN GUIDE

02 → YC110-1004 (FACTORY 2012-2018/ PILOT - BIGY - SUNDAY)
03 → YC110-1005 (START)

€ 39



GUIDE CHAÎNE RENFORCÉ FACTORY 2019-21 ADAPTABLE SUR TOUTES LES PILOT/ FACTORY/ BIGY

2019-21 FACTORY REINFORCED CHAIN GUIDE SUITABLE FOR ALL PILOT/ FACTORY/ BIGY

→ YC110-1018-04

€ 45



PATIN CHAÎNE R START 2011-2021
CHAIN SLIDER FOR R START 2011-2021

01 → YC110-10-023

€ 12

PATIN BRAS OSCILLANT POUR BRAS ALU 420mm OU 460mm 2011-2021
SWING ARM SLIDER FOR 420mm OR 460mm ALUMINIUM ARM 2011-2021

02 → YC110-10-025

€ 12

PATIN BRAS OSCILLANT CANTILEVER LITE
LITE CANTILEVER SWING ARM SLIDER

03 → YC110-1005-02

€ 12

PATIN CHAÎNE COURT POUR BRAS CANTILEVER
SHORT CHAIN SLIDER ADAPTABLE FOR CANTILEVER ARM

04 → YC110-10-021

€ 10

AMORTISSEURS SHOCK ABSORBERS

FACTORY
SPECIAL PARTS
YCF RACING



AMORTISSEUR SHOCK ABSORBER

01	→ YC50-0404-03 (200mm YCF 50)	€ 89
02	→ YC110-0404-82 (270mm CANTILVER - LITE 88 - 125)	€ 129
04	→ YC110-0404-15 (265mm MONO ARM/ BRAS - START F88)	€ 139
04	→ YC110-0404-14 (270mm MONO ARM/ BRAS - START F125)	€ 139
04	→ YC110-0404-17 (310mm MONO ARM/ BRAS - PILOT 125/150 2013-21 & SM150 2013-21)	€ 139
04	→ YC110-0404-81 (330mm MONO ARM/BRAS PILOT 125/150 2020-21)	€ 179
04	→ YC110-0404-67 (355mm MONO ARM/ BRAS - BIGY)	€ 139
03	→ YC110-0404-07 (280mm RÉGLABLE/ ADJUSTABLE)	€ 199
03	→ YC110-0404-16 (330mm RÉGLABLE/ ADJUSTABLE - SP2)	€ 199
03	→ YC110-0404-68 (355mm RÉGLABLE/ ADJUSTABLE - BIGY)	€ 199

ENTRETOISE D'AMORTISSEUR Ø 12 SHOCK ABSORBER SPACERS Ø 12

05	→ YC110-04192 (RSP, CLASSIC, FACTORY 2010-2021)	€ 6
06	→ YC110-0419 (START/ PILOT 2010-2021)	€ 4



AMORTISSEUR DNM DNM SHOCK ABSORBER

→ YC110-0404-83 270mm ressort/spring 800lbs	€ 319
→ YC110-0404-84 270mm ressort/spring 1000lbs	€ 319
→ YC110-0404-35 310mm ressort/spring 1000lbs	€ 319



KIT RABAISSÉ AMORTISSEUR HEIGHT ADJUSTMENT KIT

01	→ YC110-1033-01 (START 88S-125-125S)	€ 59
02	→ YC110-1030-02 (LITE)	€ 59



RESSORT PLUS SOUPLE ET PLUS DUR SOFTER AND HARDER SPRING

01	→ YC110-0417-22-WH (START/ SM 88-125)	€ 39
	→ YC110-0417-23-WH (PILOT 125-150/ SM 150) (SOUPLE 600 lbs)	
02	→ YC110-0417-27-BK (START/ SM 88-125)	€ 39
	→ YC110-0417-28-BK (PILOT 125-150/ SM 150) (DUR 800 lbs)	



BAVETTE D'AMORTISSEUR YCF YCF MUD FLAP

→ YC110-0460-01 (POUR/FOR PILOT/FACTORY/BIGY)	€ 15
---	------

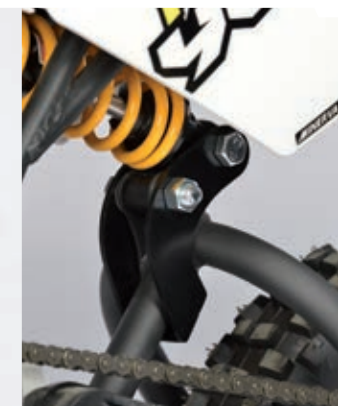

ROUES, JANTES & MOYEUX WHEELS, RIMS & HUBS



KIT ROUE SUPERMOTO MOBSTER 12'
(2.15 X 12' AVANT/ 3.00 X 12' ARRIÈRE)

MOBSTER SUPERMOTO PAIR OF WHEELS SET 12'
(2.15 X 12' FRONT/ 3.00 X 12' REAR)

→ KWMOBSTER01-BK

€ 199



KIT ROUE SUPERMOTO MOBSTER VORTEX 12'
(2.15 X 12' AVANT/ 2.75 X 12' ARRIÈRE)

MOBSTER VORTEX SUPERMOTO WHEELS SET 12'
(2.15 X 12' FRONT/ 2.75 X 12' REAR)

→ KWMOBSTER02-BK

€ 299



ROUE SUPERMOTO ALU
(VENDUE AVEC DISQUE DE FREIN & COURONNE)

SUPERMOTO WHEEL ALU
(SOLD WITH BRAKE DISC & SPROCKET)

→ YC110-0601-93 (2.15x14 AVANT/ FRONT) € 169
→ YC110-1101-73 (3.00x14 ARRIÈRE/ REAR) € 189



**NEW
2021**

KIT ROUE SUPERMOTO YCF 10'
(2.15 X 10' AVANT/ 2.50 X 10' ARRIÈRE)

YCF SUPERMOTO WHEEL SET 10'
(2.15 X 10' FRONT/ 2.50 X 10' REAR)

→ YC110-0625-01-BK

€ 219



**NEW
2021**

KIT ROUE SUPERMOTO YCF 12'
(2.15 X 12' AVANT/ 2.75 X 12' ARRIÈRE)

YCF SUPERMOTO WHEEL SET 12'
(2.15 X 12' FRONT/ 2.75 X 12' REAR)

→ YC110-0626-01-BK

€ 219



ROUE SUPERMOTO (ACIER)
(VENDUE AVEC DISQUE DE FREIN & COURONNE)

SUPERMOTO STEEL WHEEL
(SOLD WITH BRAKE DISC)

→ YC110-06017 (1,85x12 AVANT/ FRONT) € 139
→ YC110-11014 (2,15x12 ARRIÈRE/ REAR) € 149



ROUE ACIER POUR AXE DE ROUE DE 15 AVEC RAYONS RENFORCÉS 4mm

STEEL WHEEL FOR 15" WHEEL AXLE WITH 4mm REINFORCED SPOKES

- YC110-0601-2901 (AVANT/ FRONT 12) € 119
- YC110-0601-30-BK (AVANT/ FRONT 14) € 119
- YC110-0601-0801 (88CC: AVANT/ FRONT 10) € 119
- YC110-1101-34-BK (ARRIÈRE/ REAR 12) € 149
- YC110-1101-01A (ARRIÈRE/ REAR 10) € 149



→ FOR 50 ONLY

ROUE AVANT OU ARRIÈRE COMPLÈTE YCF 50

COMPLETE FRONT OR REAR WHEEL FOR YCF 50

- YC50-0601-0401 (AVANT/ FRONT) € 99
- YC50-1101-0401 (ARRIÈRE/ REAR) € 139



→ FOR 50 ONLY

ROUE COMPLÈTE AVEC MOYEURS CNC ROUGE/ BLEUE/ VERTE/ ORANGE/ NOIRE

COMPLETE WHEEL WITH CNC HUB RED/ BLUE/ GREEN/ ORANGE/ BLACK

- YC50-0611-01 + COLOR (AVANT/ FRONT) € 139
- YC50-1101 + COLOR (ARRIÈRE/ REAR) € 149



ROUE COMPLETE ACIER RENFORCÉE POUR AXE DE ROUE DE 15, MOYEURS ARRIÈRE AVEC 5 VIS DE FIXATION POUR COURONNE

COMPLETE REINFORCED STEEL WHEEL AXLE 15, REAR HUB WITH 5 SCREWS FIXATION FOR SPROCKET

- YC110-1101-2D (ARRIÈRE/ REAR 12) € 169
- YC110-0601-5B (AVANT/ FRONT 14) € 139



ROUE COMPLETE ACIER RENFORCÉE POUR AXE DE ROUE DE 15, MOYEURS ARRIÈRE AVEC 5 VIS DE FIXATION POUR COURONNE

COMPLETE REINFORCED STEEL WHEEL AXLE 15, REAR HUB WITH 5 SCREWS FIXATION FOR SPROCKET

- YC110-1101-29-BK (ARRIÈRE/ REAR 14) € 149
- YC110-0601-39-BK (AVANT/ FRONT 17) € 139

ROUE COMPLÈTE RENFORCÉE, MOYEURS CNC,
CERCEAU ALU, 7116, VENDUE AVEC DISQUE & COURONNE
ROUGE/ BLEU/ ORANGE/ NOIRE/ VERTE

COMPLETE REINFORCED WHEEL, CNC HUB, ALU,
7116 RIM (SOLD WITH BRAKE DISC & SPROCKET)
RED/ BLUE/ ORANGE/ BLACK/ GREEN

→ YC110-0601-40 + COLOR (AVANT/ FRONT 17) € 189
→ YC110-1101-32 + COLOR (ARRIÈRE/ REAR 14) € 199



FACTORY
SPECIAL PARTS
YCF RACING

AT 7116

YCF



ROUE COMPLÈTE RENFORCÉE, MOYEURS CNC, CERCEAU ALU, 7116, VENDUE AVEC DISQUE & COURONNE ROUGE/ BLEU/ ORANGE/ NOIRE/ VERTE
COMPLETE REINFORCED WHEEL, CNC HUB, ALU, 7116 RIM (SOLD WITH BRAKE DISC & SPROCKET) RED/ BLUE/ ORANGE/ BLACK/ GREEN

- YC110-06012 + COLOR (AVANT/ FRONT 12)
- YC110-0601-37 (AVANT/ FRONT 14)
- YC110-1101-25 (ARRIÈRE/ REAR 12)

€ 169
€ 169
€ 199



CERCEAU DE ROUE ALU. 7116
ALUMINIUM 7116 M SHAPE RIM

- YC110-1117-16-BK (1,85x12 AV./ FRONT - AR./ REAR)
- YC110-1117-16-SI (1,85x12 IDEM) € 59
- YC110-0617-22BK (1,40x14 AV./ FRONT)
- YC110-0617-22SI (1,40x14 AV./ FRONT) € 59
- YC110-0617-40-BK (1,60x17 AV./ FRONT) € 59
- YC110-1107-32-BK (1,85x14 AR./ REAR) € 59



CERCEAU DE ROUE ACIER POUR RAYON 4mm
STEEL RIM WITH 4mm SPOKES

- ↪ YC110-1107-34-BK (1,85X12 AV./ FRONT - AR./ REAR) € 30
- ↪ YC110-1101-014 (2,15X12 AV./ FRONT - AR./ REAR) € 30
- ↪ YC110-0617-19-BK (1,40x12 AV./ FRONT) € 30
- ↪ YC110-0617-30-BK (1,40x14 AV./ FRONT) € 30
- ↪ YC110-0617-39-BK (1,60x17 AV./ FRONT) € 30
- ↪ YC110-1107-29-BK (1,85x14 AR./ REAR) € 30



ROULEMENT DE ROUE AVANT OU ARRIÈRE
FRONT OR REAR WHEEL BEARING

- 01 ↪ 96140-6202-2Z € 6

JOINT SPY DE ROUE
WHEEL OIL SEAL

- 02 ↪ YC50-0610 (Ø22X31.5X5) (POUR/ FOR YCF 50)
- 02 ↪ YC110-0610 (Ø25X35X6.5)
(POUR MOYEUX CNC 2012/ FOR CNC HUB)
- 02 ↪ YC110-0611 (Ø23X35X5) (POUR MOYEUX
INJECTÉ-CNC/ FOR MOLDED-CNC HUB) € 6

GRIPSTER ARRIÈRE OU AVANT
REAR OR FRONT RIM LOCK

- 03 ↪ GRIPSTERAR-R (ARRIÈRE/ REAR)
- 03 ↪ GRIPSTERA-V-R (AVANT/ FRONT) € 12



JEU DE RAYONS AVANT OU ARRIÈRE 4mm
FRONT OR REAR SET OF SPOKES 4mm

AVANT/ FRONT:

- ↪ JR10-10.6 (50A/ 50E)
- ↪ JR12-12.1-8K (88E/ START 88SE)
- ↪ JR10-10.1-8K (LITE 88)
- ↪ JR14-14.8-8K (LITE 125/ START 125S/ START 125SE
/ PILOT 125/ PILOT 150)
- ↪ JR14-15.0-8K (SP2/ SP3)
- ↪ JR17-18.4-8K (BIGY 125/ 150)
- ↪ JR17-18.5-8K (BIGY F150/ 190D/ 190ZE)
- ↪ JR12-12.5 (SM) € 25

ARRIÈRE/ REAR:

- ↪ JR10-10.5 (50A/ 50E)
- ↪ JR10-10.4-8K (88E/ LITE 88/ START 88SE)
- ↪ JR12-12.8-8K (LITE 125/ START 125S/ START 125SE
/ PILOT 125/ PILOT 150)
- ↪ JR12-13.5-8K (SP2/ SP3)
- ↪ JR14-15-8K (BIGY 125/ 150)
- ↪ JR14-15.1-8K (BIGY F150/ 190D/ 190ZE)
- ↪ JR12-12.6-10K (SM) € 25



AXE DE ROUE AVANT OU ARRIÈRE
FRONT OR REAR WHEEL AXLE

- 01 ↪ YC110-11-075 (FACTORY 2011-2021)
- 02 ↪ YC110-11-07 (ARRIÈRE/ REAR)
- 03 ↪ YC110-06-06 (AVANT/ FRONT)
- 04 ↪ YC110-06-061 (TYPE MARZOCCHI®) € 7



COUVRE RAYON (KIT DE 38 PCS AVANT 215 MM/ 38 PCS ARRIÈRE 190mm)
ROSE/ ROUGE/ BLEUE/ JAUNE/ VERT/ ORANGE

SPOKE SKIN SET (INCLUDES 38 FRONT PCS-215mm & 38 REAR PCS-190mm)
PINK/ RED/ BLUE/ YELLOW/ GREEN/ ORANGE

↪ SPKAS01-COLOR

€ 19



MOYEURS ROUE AVANT OU ARRIÈRE CNC BLEU/ ROUGE/ ORANGE/ VERT/ NOIR
WHEEL HUB CNC FRONT OR REAR RED/ ORANGE/ GREEN/ BLUE/ BLACK

- 01 → YC110-0622-22 + COLOR (AVANT/ FRONT)
02 → YC110-1122-16 + COLOR (ARRIÈRE/ REAR) € 119

JEU ENTRETOISES DE ROUE CNC POUR MOYEURS INJECTÉE LITE/ START/ PILOT/ BIGY MX125/150 BLEUES/ ROUGES/ NOIRES/ ORANGES/ VERTES
SET OF CNC WHEEL SPACERS FOR CASTING HUB LITE/ START/ PILOT/ BIGY MX125/150 BLUE/ RED/ BLACK/ ORANGE/ GREEN

- 03 → ERC1AV + COLOR (AVANT/ FRONT 15x22x33 & 15x22x23)
03 → ERC1AR + COLOR (ARRIÈRE/ REAR 15x22x38 & 15x22x29) € 15

ENTRETOISE DE ROUE
WHEEL SPACER

- 04 → YC110-06-052 (AVANT GAUCHE/ FRONT LEFT) Ø 15X22X33
LITE/ START/ PILOT/ BIGY MX125-150
04 → YC110-06-047 (AVANT DROITE/ FRONT RIGHT) Ø 15X22X23
LITE/ START/ PILOT/ BIGY MX125-150
04 → YC110-11-052 (ARRIÈRE GAUCHE/ REAR LEFT) Ø 15X22X38
LITE/ START/ PILOT/ BIGY MX125-150
04 → YC110-11-041 (ARRIÈRE DROITE/ REAR RIGHT) Ø 15X22X29
LITE/ START/ PILOT/ BIGY MX125-150 € 6

ENTRETOISE DE ROUE MOBSTER
MOBSTER WHEEL SPACER

- FB13-15X22X19-W (AVANT DROITE)
→ FB13-15X22X23-W (ARRIÈRE DROITE)
→ FB13-15X22X28-W (AVANT GAUCHE)
→ FB13-15X22X34-W (ARRIÈRE GAUCHE) € 6

ENTRETOISE CENTRALE DE MOYEURS
CENTRAL HUB SPACER

- 05 → YC110-0601-02 (CENTRAL AVANT/ FRONT) Ø 15x22x44
05 → YC110-0601-021 (CENTRAL AVANT/ FRONT) Ø 16x21x53
05 → YC110-0601-022 (CENTRAL AVANT/ FRONT) Ø 15x22x43

- 05 → YC110-1101-03 (INT, ARRIÈRE/ INNER REAR) Ø 16x21x84
05 → YC110-1101-04 (INT, ARRIÈRE/ INNER REAR) Ø 16x21x64
05 → YC110-1101-05 (INT, ARRIÈRE/ INNER REAR) Ø 16x21x59
05 → YC110-1101-06 (INT, ARRIÈRE/ INNER REAR) Ø 16x21x74 € 6

ENTRETOISE SP3 2019 (TÉ 170 mm)
CENTRAL HUB SPACER

- 04 → YC110-0609-08 (AVANT DROITE/ FRONT RIGHT) € 6
04 → YC110-0610-08 (AVANT GAUCHE/ FRONT LEFT)



FACTORY
SPECIAL PARTS
YCF RACING

AI 7116



↙ PNEUS TIRES



CHAMBRE À AIR RENFORCÉE 4mm
REINFORCED TUBE 4mm

- 01 → CHAMBRE10RENF (Ø 10" FRONT-REAR/ AV,-AR,) € 12
- 01 → CHAMBRE12RENF (Ø 12" FRONT-REAR/ AV,-AR,) € 12
- 01 → CHAMBRE14RENF (Ø 14" AV,/ FRONT) € 12
- 01 → CHAMBRE14ARRENF (Ø 14" AR,/ REAR) € 15
- 01 → CHAMBRE17RENF (Ø 17" AV,/ FRONT) € 15

CHAMBRE À AIR STANDARD
STANDARD TUBE

- 01 → CHAMBRE10-2,5 (Ø 10" POUR/FOR YCF 50)
- 01 → CHAMBRE12AV (Ø 12" AVANT/ FRONT) € 9

FOND JANTE
TIRE LINING

- 02 → YC110-11-01 (ROUE/ WHEEL 10/12")
- 02 → YC110-06-01 (ROUE/ WHEEL 14")
- 02 → YC110-06-07 (ROUE/ WHEEL 17") € 2



BOUCHON DE VALVE CNC
BLEU/ ROUGE/ NOIR/ ORANGE/ VERT
VALVE CAP SET
BLUE/ RED/ BLACK/ ORANGE/ GREEN

→ TVC + COLOR € 4



PNEU AVANT CROSS 2,50/10
FRONT CROSS TIRE IN 2,50/10

→ 250/10 € 25



PNEU ARRIÈRE CROSS EN 3,00/10
REAR CROSS TIRE IN 3,00/10

→ 300/10 € 32



PNEU AVANT CROSS EN 60/100/12
FRONT CROSS TIRE IN 60/100/12

→ 60/100/12 € 29



PNEU ARRIÈRE CROSS EN 80/100/12
REAR CROSS TIRE IN 80/100/12

→ 300/12 € 29



PNEU AVANT CROSS EN 60/100/14
FRONT CROSS TIRE IN 60/100/14

→ 60/100/14 € 29



PNEU ARRIÈRE CROSS EN 90/100/14
REAR CROSS TIRE IN 90/100/14

→ 90/100/14 € 39



PNEU AVANT CROSS EN 70/100/17
FRONT CROSS TIRE IN 70/100/17

→ 70/100/17 € 39

KENDA

**NEW
2021**



PNEU KENDA® SUPERMOTARD K702
KENDA® SUPERMOTARD K702 TIRE

- 90/90-10K702
- 100/90-10K702
- 110/70-12K702
- 120/70-12K702

€ 59

€ 59



ARRO™



PNEU ARRO® SPIDER CROSS EN 300/10
SPIDER ARRO® TIRE 300/10

→ 300/10 ARRO

€ 39

ARRO™



PNEU ARRO® SPIDER CROSS AVANT EN 60/100/12
SPIDER ARRO® TIRE FRONT 60/100/12

→ 60/100/12 ARRO

€ 39

ARRO™



PNEU ARRO® SPIDER CROSS ARR, EN 80/100/12
SPIDER ARRO® TIRE REAR 80/100/12

→ 80/100/12ARRO

€ 42

ARRO™



PNEU ARRO® SPIDER CROSS AVANT EN 60/100/14
SPIDER ARRO® TIRE FRONT 60/100/14

→ 60/100/14ARRO

€ 41

ARRO™



PNEU ARRO® SPIDER CROSS ARR, EN 90/100/14
SPIDER ARRO® TIRE TRAR 90/100/14

→ 90/100/14 ARRO

€ 50

ARRO™



PNEU ARRO® SPIDER® CROSS AVANT EN 70/100/17
SPIDER ARRO® TIRE FRONT 70/100/17

→ 70/100/17 ARRO

€ 48

REPOSE-PIEDS & SABOTS FOOT PEGS & SKID PLATES



BARRE DE REPOSE-PIED
FOOT PEGS MOUNT BAR

→ YC110-0901-01 (GAMME START/ START RANGE) € 29



**RÉSERVOIR RÉCUPÉRATEUR DE LIQUIDE
AVEC SEPARATEUR HUILE/ ESSENCE**
RECUPERATOR TANK WITH SEPARATOR OIL/ GAZ

→ YC110-0816-02 € 39



PLATINE RÉGLABLE AVEC REPOSE PIED SUPERMOTARD
SUPERMOTARD ADJUSTABLE FOOT PEGS KIT

→ YC110-0919-01 € 69



SABOT MOTEUR ACIER
STEEL SKID PLATE

→ YC110-202-01 (ACIER/ STEEL 88/125/140) € 39
→ YC110-202-02 (ACIER/ STEEL 88/125 SE) € 39
→ YC110-0905-02 (ACIER/ STEEL ZS190) € 49

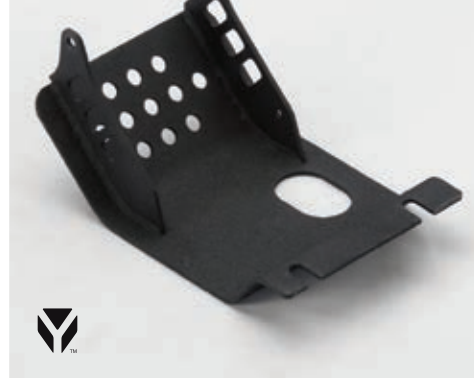

SABOT POUR FACTORY
SKID PLATE FOR FACTORY

→ YC110-207-03 (FACTORY SP1) € 49
→ YC110-207-04 (FACTORY SP2)
→ YC110-207-05 (FACTORY SP3)



**NEW
2021**



**SABOT RÉCUPÉRATEUR HUILE SUPERMOTARD EN
FIBRE DE VERRE BLANC/ NOIR**
RACE BELLY PAN WHITE/ BLACK

→ YC110-202-03-WH € 79
→ YC110-202-03-BK € 79
(Adaptable sur toute la gamme YCF/ fit on all YCF range)



FACTORY
SPECIAL PARTS
YCF RACING

JEU DE REPOSE-PIED ALUMINIUM NOIR/ ROUGE/ BLEU/ ORANGE/ VERT
ALUMINIUM FOOT PEGS BLACK/ RED/ BLUE/ ORANGE/ GREEN

→ RPALU + COLOR € 69

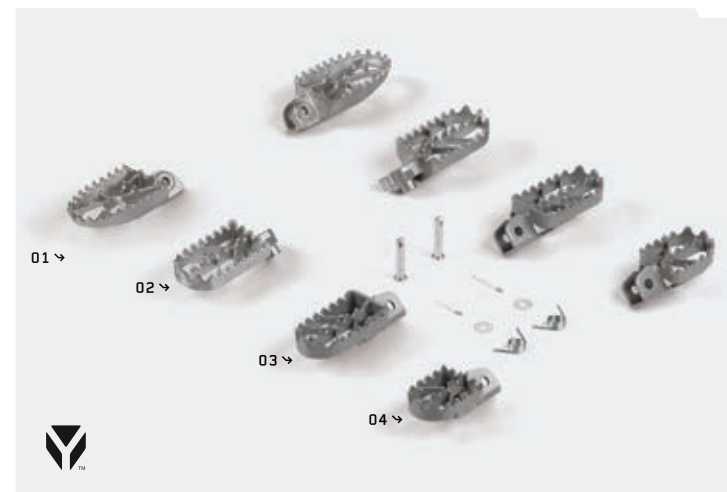

JEU DE REPOSE-PIED
FOOT PEGS SET

01 → YC110-0902/05 (INOX LARGE/ LARGE STAINLESS STEEL) € 49
02 → YC110-0902/04 (INOX/ STAINLESS STEEL)
03 → YC110-0902/13 (ACIER/ STEEL)
04 → YC110-0902/06 (SUPERMOTO) € 29



KIT COMPLET PROTECTION TEFLON SUPERMOTO
SUPERMOTO TEFLON PROTECTION SET

→ KS1 € 59



KIT PATIN TEFLON SUPERMOTO
SUPERMOTO TEFLON SET

→ KS4 € 35



KIT BOCAL RÉCUPÉRATEUR HUILE ET ESSENCE SUPERMOTO
SUPERMOTO OIL AND FUEL RECUPERATOR KIT

→ KS3 € 29

SÉLECTEURS SHIFT LEVERS



SÉLECTEUR ALUMINIUM CNC AVEC DÉPORT POUR AXE SÉLECTEUR COURT
NOIR/ BLEU/ ROUGE/ ORANGE/ VERT

ALUMINIUM CNC GEAR LEVER WITH EXTENSION FOR SHORT LEVER SHAFT
BLACK/ BLUE/ RED/ ORANGE/ GREEN

01 → STMD + COLOR € 39

SÉLECTEUR ALUMINIUM NOIR/ BLEU/ ROUGE/ ORANGE/ VERT
ALUMINIUM SHIFT LEVER BLACK/ BLUE/ RED/ ORANGE/ GREEN

02 → 24700 + COLOR € 29



KICK ACIER ORIGINE
ORIGINAL STEEL KICKSTARTER

01 → 43451/152FMH (Ø 13mm) € 15
01 → 43452/152FMH (Ø 16mm)

KICK ACIER RENFORCÉ
REINFORCED KICKSTARTER

02 → YC140-27500SI (Ø 13mm) € 50
02 → YC140-27600SI (Ø 16mm)

RESSORT/ BILLE/ VIS POUR KICK
BALL, SPRING, AND SCREW FOR KICKSTARTER

03 → KVK € 3



SÉLECTEUR ACIER REPLIABLE
FOLDABLE STEEL SHIFT LEVER

01 → 24700/152FMI/3V (AVEC DÉPORT/ WITH EXT.)
01 → 24700/152FMH/02 (190 ZONGSHEN ENGIN)
02 → 24700/152FMH/03 € 13

SÉLECTEUR ACIER REPLIABLE ET RÉGLABLE
FOLDABLE & ADJUSTABLE STEEL SHIFT LEVER

03 → 24700-D (AVEC DÉPORT/ WITH EXT.) € 15
04 → 24700-SD

KIT CHAÎNE & TRANSMISSION SPROCKET KITS & TRANSMISSIONS

SPECIAL PARTS
YCF RACING



COURONNE ACIER Ø INTÉRIEUR 75 - ENTRAXE COURONNE 92 - 5 TROUS DE FIXATION POUR FACTORY 2016-21

STEEL SPROCKET INNER Ø 75 - SPROCKET CENTRE TO CENTRE DISTANCE 92 - 5 HOLES FIXATION FOR FACTORY 2016-21

- YC110-11-062/41 (41 DENTS/ TEETH)
- YC110-11-062/45 (45 DENTS/ TEETH)

€ 15

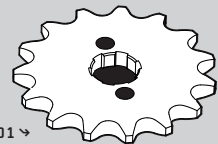

01 →



02 →



03 →

PIGNON SORTIE BOÎTE & PLAQUE PIGNON

COUNTERSHAFT SPROCKET & SPROCKET PLATE

- 01 → 22711/152FMI14 (Ø 20 PIGNON 14 DENTS/ SPROCKET 14 TEETH)
- 01 → 22711/152FMI15 (Ø 20 PIGNON 15 DENTS/ SPROCKET 15 TEETH)
- 02 → 22712/152FMH (Ø 17 PLAQUE PIGNON/ SPROCKET PLATE)
- 02 → 22712/152FMI (Ø 20 PLAQUE PIGNON/ SPROCKET PLATE)
- 03 → RS35/10T (PIGNON 10 DENTS YCF 50E/ YCF 50E SPROCKET 10 TEETH)
- 03 → RS35/10T-01 (PIGNON 10 DENTS W88/ W88 SPROCKET 10 TEETH)

€ 8

€ 6

€ 10

SPECIAL PARTS
YCF RACING



CHAÎNE RENFORCÉE 420 110 MAILLONS ROUGE/ BLEUE/ VERTE/ ORANGE/ JAUNE
REINFORCED CHAIN 420 110 LINKS RED/ BLUE/ GREEN/ ORANGE/ YELLOW

- 420DX-110T + COLOR
- 420DX-116T + COLOR (BIGY)

€ 20

€ 20

SPECIAL PARTS
YCF RACING



01 →



02 →



COURONNE ACIER Ø INTÉRIEUR 75 - ENTRAXE COURONNE 92

STEEL SPROCKET INNER Ø 75 - SPROCKET CENTRE TO CENTRE DISTANCE 92

- 01 → YC110-11-06/41 (41 DENTS/ TEETH)
- 01 → YC110-11-06/45 (45 DENTS/ TEETH)
- 02 → YC110-11-05/60 (60 DENTS/ TEETH - YCF 50E/ W88)

€ 15

€ 35

SPECIAL PARTS
YCF RACING



PIGNON SORTIE BOÎTE ANTI BOUE Ø 17
ANTI MUD COUNTERSHAFT SPROCKET Ø 17

- 22711/152FMZ13 (13 DENTS/ TEETH)
- 22711/152FMZ14 (14 DENTS/ TEETH)
- 22711/152FMZ15 (15 DENTS/ TEETH)
- 22711/152FMZ16 (16 DENTS/ TEETH)
- 22711/152FMZ17 (17 DENTS/ TEETH)
- 420H/10T (10 DENTS/ TEETH) (YCF 50A)

€ 8

01 →



02 →

CHAÎNE 420 ET RS35

CHAIN 420 AND RS35

- 01 → 420H-104T (104 MAILLONS/ LINKS) € 17
- 01 → 420H-110T (110 MAILLONS/ LINKS) € 17
- 01 → 420H-116T (116 MAILLONS/ LINKS BIGY) € 19
- 01 → RS35-114T (114 MAILLONS/ LINKS 50E) € 19

ATTACHE RAPIDE

CHAIN JOINING LINK

- 02 → AR-420
- 02 → AR-35 (YCF 50E)

€ 3



37 39 41 43 45 47

COURONNE ALU. TAILLÉE DANS LA MASSE DISPONIBLE EN 37, 39, 41, 43, 45, 47 DENTS NOIRE/ VERTE/ BLEUE/ ROUGE/ ORANGE
Ø INTÉRIEUR 75 - ENTRAXE COURONNE 92

BILLET ALUMINIUM SPROCKET AVAILABLE IN 37, 39, 41, 43, 45, 47 TEETH BLACK/ GREEN/ BLUE/ RED/ ORANGE
INNER Ø 75 - SPROCKET CENTRE TO CENTRE DISTANCE 92

→ CA06R + NOMBRE DENTS & COULEUR/ NUMBER OF TEETH & COLOR

€ 39



KIT VIS COURONNE
SCREW SET FOR SPROCKET

- 01 → KVC
- 02 → KVC-1 (TÊTE FRAISÉE/ FLAT HEAD)
- 04 → KVC-2 (KIT VIS PLATES/ SPROCKET BOLT KIT FLAT HEAD)

€ 3

BLOC COURONNE
BLOCK SPROCKET

03 → YC110-11-03

€ 2



TENDEUR CHAÎNE CNC NOIR/ ROUGE/ BLEU/ ORANGE/ VERT
CNC AXLE BLOCK BLACK/ RED/ BLUE/ ORANGE/ GREEN

- 01 → TC07 + COLOR (Ø 15) (POUR BRAS ACIER/ FOR STEEL SWING ARM)
- 02 → TC12 + COLOR (POUR BRAS ALU/ FOR ALU SWING ARM - 2011-2021)
- 03 → TC-COLOR (Ø 12 RED OR BLACK ONLY/ ROUGE OU NOIR SEULEMENT)

€ 19



41 43 45 47

COURONNE ALU, TAILLÉE DANS LA MASSE - 5 TROUS DE FIXATION POUR FACTORY 2016 - DISPONIBLE EN 41, 43, 45, 47 DENTS NOIRE/ VERTE/ BLEUE/ ROUGE/ ORANGE - Ø INTÉRIEUR 75 - ENTRAXE COURONNE 92

BILLET ALUMINIUM SPROCKET - 5 HOLE FIXATION FOR FACTORY AVAILABLE IN 41, 43, 45, 47 TEETH BLACK/ GREEN/ BLUE/ RED/ ORANGE - INNER Ø 75 - SPROCKET CENTRE TO CENTRE DISTANCE 92

→ CA16R + NOMBRE DENTS & COULEUR/ NUMBER OF TEETH & COLOR

€ 39



PROTECTION PIGNON SORTIE BOÎTE (VIS & ENTRETOISES INCLUSES)
COUNTERSHAFT SPROCKET GUARD (SCREWS & SPACERS INCLUDED)

- 01 → YC110-253BK (PILOT - FACTORY)
- 02 → YC110-251BK (START)

€ 15



FREIN FILET - ROUGE: FORT/ BLEU: MOYEN
THREADLOCKER - RED: STRONG/ BLUE: MEDIUM

09 → FF271 (STRONG/ FORT)
 10 → FF242 (MEDIUM/ MOYEN)

€ 18

CLÉ À BOUGIE
 SPARK PLUG REMOVAL TOOL

01 → CB € 6

ARRACHE VOLANT 3 EN 1
 ADAPTABLE SUR TOUS LES MOTEURS DE MINI
 FLYWHEEL REMOVER 3 IN 1
 SUITABLE FOR ALL MINI BIKES ENGINES

02 → ARRACHE-1 € 12

OUTIL POUR DÉMONTER NOIX EMBRAYAGE ET ÉPURATEUR
 CLUTCH TOOL

03 → OUTIL € 15

DÉRIVE CHAÎNE PROFESSIONNEL
 PROFESSIONAL CHAIN TOOL

04 → DERIVE-1 € 25

CLÉ À RAYONS
 NIPPLE WRENCH

05 → CLEARAYON € 7

JEU DE CALES MOTEUR
 SET OF ENGINE ADJUSTMENT GAUGES

06 → JCM-1 € 7

CONTRÔLEUR DIGITAL DE PRESSION DE PNEU
 DIGITAL TIRE PRESSURE GAUGE

07 → CDP € 16

DÉMONTE PNEU EN CUILLÈRE
 SPOON TIRE LEVER

08 → DEMONT-1 € 10

OUTIL RÉGLAGE SOUPAPES
 VALVE ADJUSTMENT TOOL/ WRENCH

**NEW
2021**

11 → YC110-2410-01 € 9





KIT DÉPART ENGI°
ENGI° LAUNCH CONTROL

→ ENGIHKF-BK

€ 59



BAGUE/ JOINT SPI/ CACHE POUSSIÈRE FOURCHE
FORK RING/ OIL SEAL/ DUST COVER

- 01 → EF03-0027 (INFÉRIEURE/ LOWER) € 12
- 02 → EF03-0005 (SUPÉRIEURE/ UPPER) € 12
- 03 → EF03-0009-01 (ENGI°) € 8
- 04 → EF03-0011-01 (ENGI°)
(VENDU À L'UNITÉ/ SELL BY UNIT) € 12



FOURCHE ENGI° RÉGLABLE COMPRESSION DÉTENTE AVEC CORPS ALUMINIUM ET TRAITEMENT DU TUBE INF.
ENGI° FORK WITH ADJUSTABLE COMPRESSION & REBOUND

→ ENGI2-800-BK (800mm)

€ 649



FOURCHE ENGI° RÉGLABLE COMPRESSION DÉTENTE
ENGI° FORK WITH ADJUSTABLE COMPRESSION & REBOUND

→ ENGI1660 (660mm)
→ ENGI1735 (735mm)

€ 599



OUTIL ASSEMBLAGE JOINT SPI ENGI°
ENGI° OIL SEAL ASSEMBLY TOOL

01 → ENGI-OST

€ 79

OUTIL CLÉ EN T ENGI°
ENGI° T-HANDLE WRENCH TOOL

02 → ENGI-PDR

€ 59



AMORTISSEUR ENGI® RÉGLABLE COMPRESSION DÉTENTE
 ENGI® SHOCK ABSORBER ADJUSTABLE COMPRESSION & REBOUND

- YC110-0404-65 (270mm PILOT)
- YC110-0404-61 (300mm PILOT)
- YC110-0404-66 (310mm PILOT)
- YC110-0404-63 (335mm FACTORY)
- YC110-0404-69 (355mm BIGY)

€ 299



KIT RÉFECTION INTERIEUR AMORTISSEUR
 ENGI® SHOCK INTERN REPAIR KIT

→ ES01-000B

€ 69



KIT RÉFECTION ENTRETOISE AXE AMORTISSEUR
 ENGI® SHOCK SPACER KIT

→ ES01-000C

€ 25

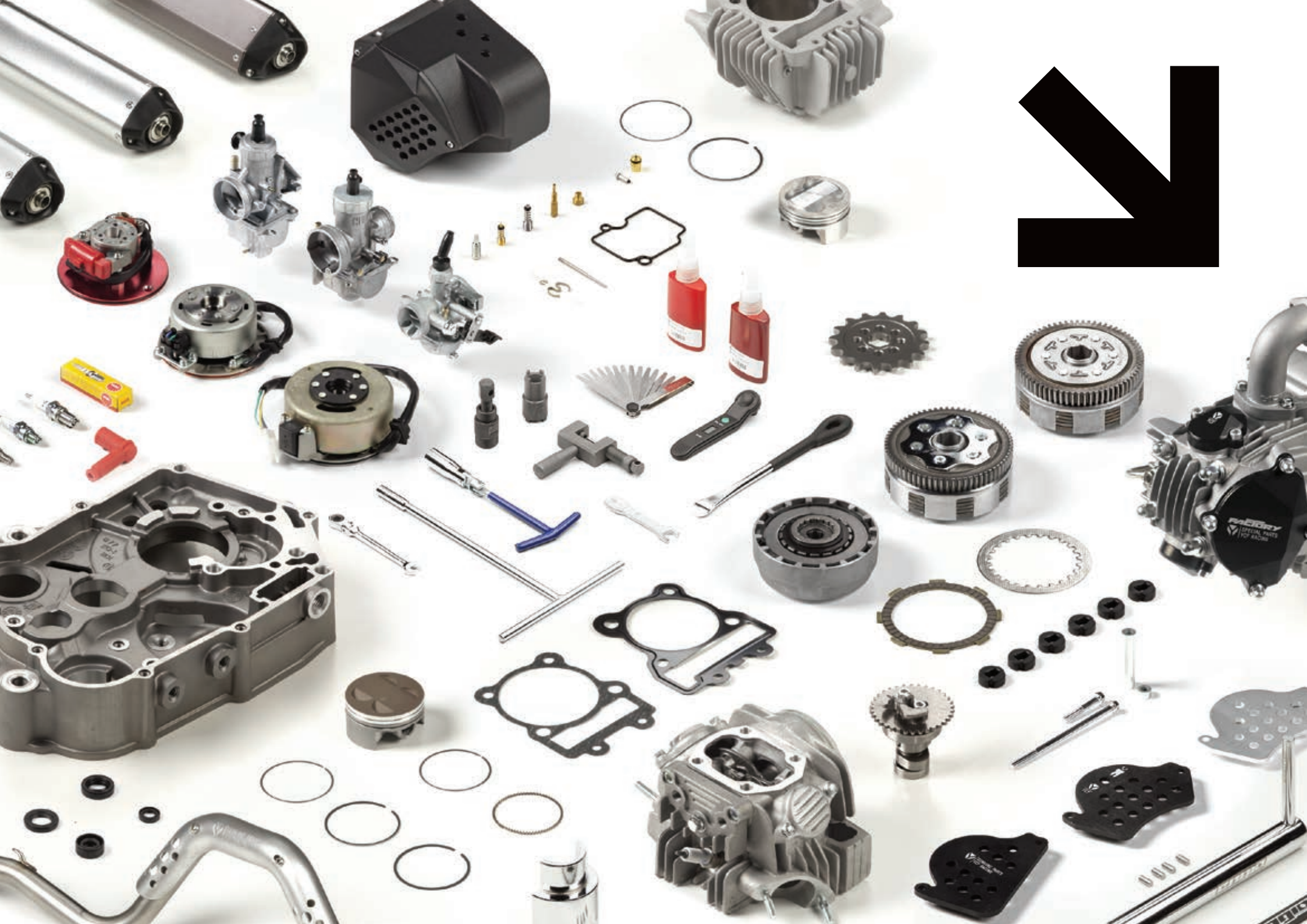

ENGINE PARTS

PIÈCES MOTEUR

MOTEURS DAYTONA®/ DAYTONA® ENGINES	112
MOTEURS/ ENGINES	113
KITS MOTEUR/ ENGINE KITS	114
EMBAYAGE/ CLUTCH	116
KITS DRESS UP/ DRESS UP KITS	118
CARBURATEURS/ CARBURETORS	120
FILTRES À AIR/ AIR FILTERS	122
ÉCHAPPEMENTS/ EXHAUSTS	123
FILTRES & RADIATEURS/ FILTERS & COOLERS	126
ALLUMAGE/ IGNITION	128
PIÈCES RACING DAYTONA®/ DAYTONA® RACING PARTS	130
PIÈCES D'ORIGINES DAYTONA®/ DAYTONA® PARTS	131



MOTEURS ENGINES

DAYTONA®

DAYTONA® EST UNE SOCIÉTÉ JAPONNAISE SPÉCIALISÉE DANS LE DÉVELOPPEMENT ET LA FABRICATION DE PIÈCES HAUTE PERFORMANCE MOTOS DEPUIS 1972. L'ENTREPRISE EST UN LEADER INTERNATIONAL DE L'INDUSTRIE DES PIÈCES RACING.
(DÉTAIL DES PIÈCES À PARTIR DE LA PAGE 130)

DAYTONA® IS A JAPANESE COMPANY SPECIALIZED IN HIGH PERFORMANCE PARTS. THEY HAVE BEEN A LEADER IN MOTORCYCLE INDUSTRY SINCE 1972. THEY PROVIDE ORIGINAL AND RACING PARTS FOR MOTORCYCLE TO THE INTERNATIONAL MARKETPLACE.
(SEE PARTS DETAILS FROM PAGE 130)

→ CARTER RENFORCÉ
→ REINFORCED CRANKCASE

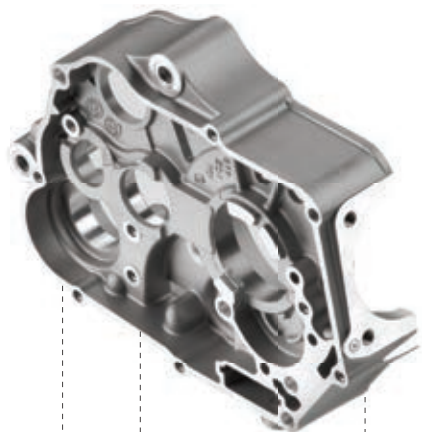

FEATURING

→ DÉCOMPRESSEUR AUTOMATIQUE
→ DECOMPRESSION SYSTEM



DAYTONA



ANIMA® 2.0 MX

MOTEURS DAYTONA® ANIMA® 2,0
DAYTONA® ANIMA® 2.0 ENGINES

- 88026 (150cc FSM)
- 87615 (190cc, 4 SPEEDS)
- 88025 (ANIMA® 160cc, FSM, 4 SPEEDS)
- 89734 (190cc, 5 SPEEDS)

€ 1299



MOTEUR DAYTONA® 190cc FE DÉMARREUR ÉLECTRIQUE 5 VITESSES
DAYTONA® 190cc FE ENGINE ELECTRIC START 5 SPEEDS

→ 88392

€ 1299

ZONGSHEN



MOTEUR ZONGSHEN® FIDDY
ZONGSHEN® FIDDY ENGINE

- MOTEUR110-G
- MOTEUR125-G
- MOTEUR150ZS

€ 599

MOTEUR 50 YCF 2012-2020 AUTOMATIC
YCF 50 ENGINE 2012-2020 AUTOMATIC

01 ↘ MOTEUR50-01-GY € 349

MOTEUR 125 À DÉMARREUR
125 4 SPEED SEMI-AUTOMATIC ENGINE ELECTRIC START

02 ↘ MOTEUR125SELE-01 € 449

MOTEUR 88 À DÉMARREUR
88 4 SPEED SEMI-AUTOMATIC ENGINE ELECTRIC START

03 ↘ MOTEUR88ELE-02 € 449

MOTEUR 88 4 VITESSES SEMI-AUTOMATIC
88 4 SPEED SEMI-AUTOMATIC ENGINE

04 ↘ MOTEUR88 € 399

MOTEUR 125 POINT MORT
125 NEUTRAL ENGINE

05 ↘ MOTEUR125P € 399

MOTEUR 125 4 VITESSES SEMI-AUTOMATIC
125 4 SPEED SEMI-AUTOMATIC ENGINE

06 ↘ MOTEUR125SEMI € 399

MOTEUR 150 TYPE KLX
150 ENGINE TYPE KLX

07 ↘ MOTEUR150-02 € 599

MOTEUR 150-3
150-3 ENGINE

08 ↘ MOTEUR150-3 € 499

MOTEUR 150 TYPE CRF
150 ENGINE TYPE CRF

09 ↘ MOTEUR150-5 € 549

MOTEUR 190 ZONGSHEN® DÉMARREUR ÉLECTRIQUE
5 VITESSES
190 ZONGSHEN® ENGINE ELECTRIC START 5 SPEEDS

10 ↘ MOTEUR190ES € 749

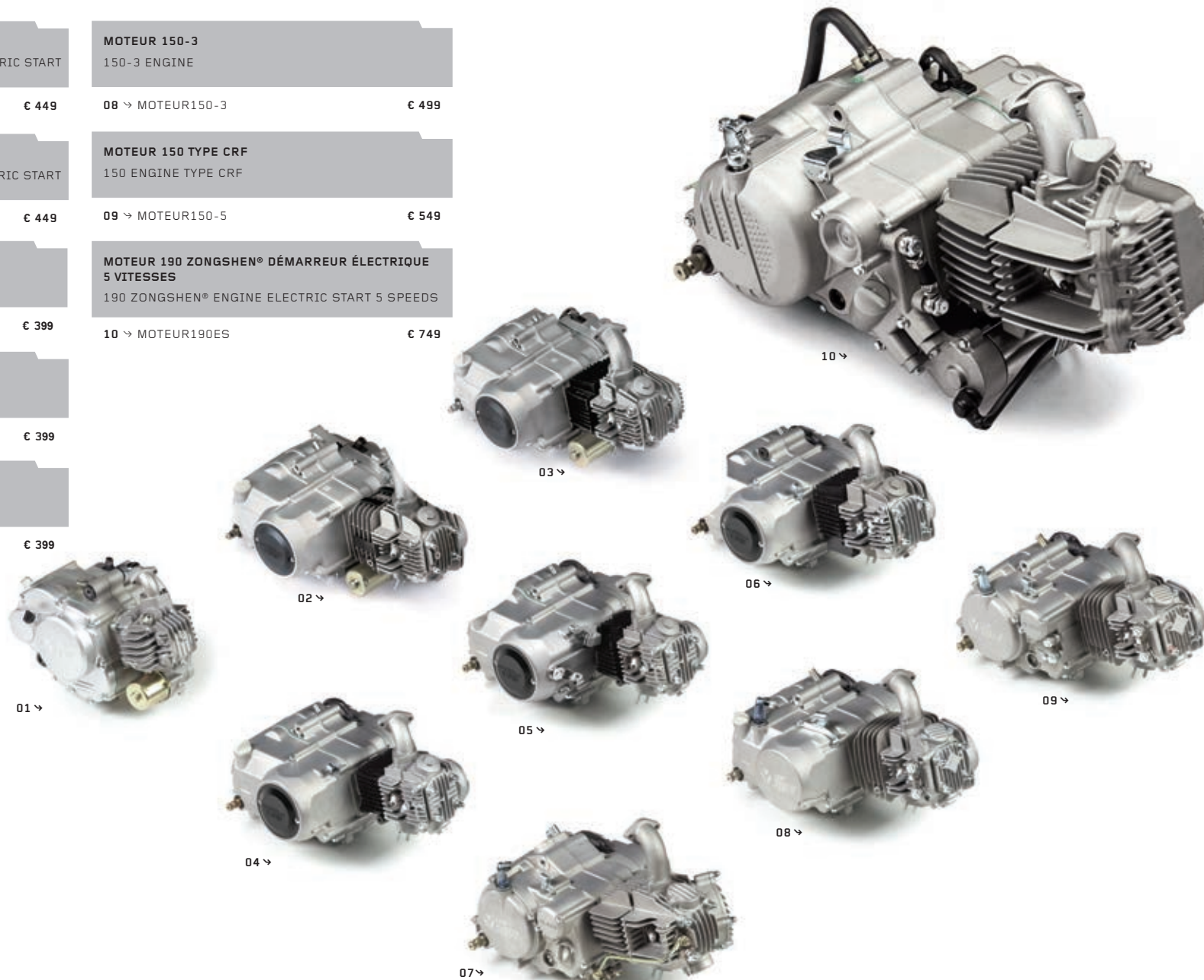

KITS MOTEUR & PIÈCES ENGINE KITS & PARTS



CARTER D'ALLUMAGE POUR DÉMARREUR ÉLECTRIQUE
IGNITION COVER ELECTRIC START

01 → 12301-D083-000189
02 → 90204-D083-000

€ 39
€ 6



CHAÎNE DE DISTRIBUTION
TIMING SPROCKET

→ D00F012 (84 MAILLONS POUR 125cc POINT MORT ET SEMI-AUTOMATIQUE/
84 TEETHS FOR 125cc NEUTRAL START AND SEMI-AUTOMATIC) € 25
→ 14350 (88 MAILLONS POUR 140cc lifan/ 88 TEETHS FOR 125cc lifan) € 25
→ 14350/152FMI (90 MAILLONS POUR 125/ 140/ 150 CRF/
90 TEETHS FOR 125/ 140/ 150 CRF TYPE) € 25
→ 210F012 (POUR YX 150/ 160 TYPE KLX/ FOR 150/ 160 YX KLX TYPE) € 39



CARTER D'ALLUMAGE
IGNITION COVER

01 → 11411/152FMH (CARTER D'ALLUMAGE/ IGNITION COVER) € 37
02 → 11411/152FMH-MG (CARTER D'ALLUMAGE/ IGNITION COVER) € 45
03 → 11411/152FMH-BK (CARTER D'ALLUMAGE/ IGNITION COVER) € 45
04 → 11419/152FMH (JOINT CARTER ALLUMAGE/ IGNITION COVER GASKET) € 6
05 → A00-8-1 (CARTER ALLUMAGE LITE 88/125) € 37



CHAÎNE DE DÉMARREUR
STARTER CHAIN

01 → 2141B-IA29-0000 POUR MOTEUR/ FOR ENGINE 88-125 SE € 10
02 → 100061493 POUR MOTEUR/ FOR ENGINE 190 ZONGSHEN® € 12



KIT PISTON
PISTON KIT

→ KPC/44-13 (YCF 50A)
→ KPC/47-13 (88 CC Ø 46,5 AXE 13)
→ KPC/52,5-13 (88/107/120/125 CC Ø 52,5 AXE 13)
→ KPC/52,5-14 (120/125 CC Ø 52,5 AXE 14)
→ KPC/54-14 (120/125 CC Ø 54 AXE 14)
→ KPC/55-15 (140 LIFAN Ø 55 AXE 15)
→ KPC/56-13 (140/150 YX TYPE CRF Ø 56 AXE 13)
→ KPC/56,5-15 (150 LIFAN Ø 56,5 AXE 15)
→ KPC/60-13 (150-160 YX TYPE KLX Ø 60 AXE 13)
→ KPC/60-13-4V (150 YX 4 V, TYPE KLX Ø 60 AXE 13)
→ KPC/62-13-4V (160 YX 4 V, TYPE KLX Ø 62 AXE 13) € 59

JEU DE SEGMENTS SEUL
PISTON RINGS SET ONLY

→ 13300F (88 CC Ø 46,5)
→ 13300/152FMI (107-125 CC Ø 52,5)
→ 13300/152FMH (125-138 CC Ø 54)
→ 13300 (140 CC Ø 55)
→ 208J013 (140-150 CC Ø 56)
→ 210J013 (150 CC Ø 60) € 20

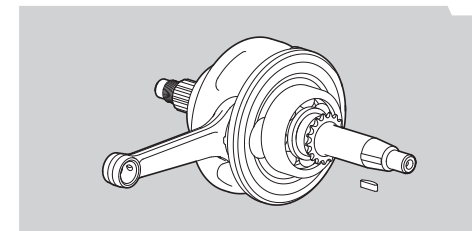

VILEBREQUIN
CRANKSHAFT

→ 13100/152FMI (125 LIFAN AXE PISTON 14)
→ 208J000 (125/140 YX AXE PISTON 13)
→ 13100 (140 LIFAN AXE PISTON 15)
→ 216J000 (150 CRFAXE PISTON 13)
→ 210J000-2 (150 KLX)
→ 2043J000 (125 POINT MORT) € 99

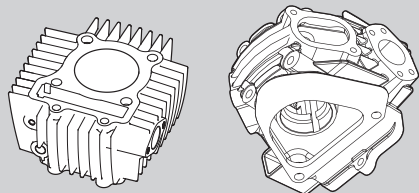

CYLINDRES & CULASSES
CYLINDERS & CYLINDER HEADS

- 01 ↪ 12110/152FMI (125 LIFAN 52,5mm)
- 01 ↪ 12112 (140 LIFAN 55mm)
- 01 ↪ 206A038 (125 YX 52,5mm)
- 01 ↪ 2081A038 (140 YX 56mm)
- 01 ↪ 208A038 (150 YX TYPE CRF)
- 01 ↪ 210A038 (150 YX TYPE KLX)
- 01 ↪ 204A038 (125 YX 54mm)

€ 99

- 02 ↪ 206A000 (125 YX)
- 02 ↪ 208A000 (140/150 YX TYPE CRF)
- 02 ↪ 210A000 (150/160 YX TYPE KLX)

€ 199

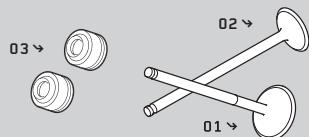

SOUPAPE D'ADMISSION
INLET VALVE

- 01 ↪ 206F045 (125 YX Ø 24)
- 01 ↪ 14710/152FMI (125, 140, 150 Ø 27)
- 01 ↪ 210F045 (KLX)

€ 19

SOUPAPE D'ÉCHAPEMENT
EXHAUST VALVE

- 02 ↪ 206F039 (125 YX Ø 21)
- 02 ↪ 14720/152FMI (125, 140, 150 Ø 23)
- 02 ↪ 210F039 (KLX)

€ 19

JOINT QUEUE SOUPAPE
VALVE STEM SEAL

- 03 ↪ 14730/152FMH

€ 5

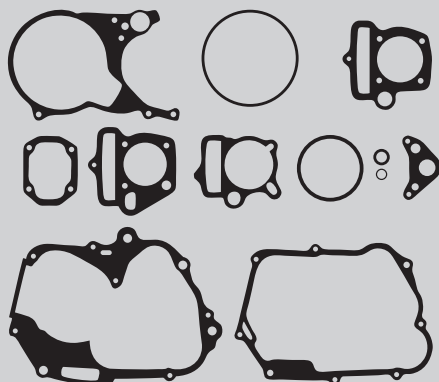

POCHETTE JOINTS COMPLÈTE
COMPLETE GASKET SET

- ↪ PJCM50 (50 YCF 2010-2011)
- ↪ PJCM50-2 (50 YCF 2011-2021)
- ↪ PJCM88 (88 CC)
- ↪ PJCMSE (START F88SE/ F125SE)
- ↪ PJCM125 (125 CC)
- ↪ PJCM140 (140 CC)
- ↪ PJCM150CRF (150 CC)
- ↪ PJCM150KLX (150 CC TYPE KLX)

€ 29

€ 29

€ 32



POCHETTE JOINTS HAUT MOTEUR
GASKET SET TOP END

- ↪ PJHM50 (50 YCF 2010-2011)
- ↪ PJHM50-2 (50 YCF 2011-2021)
- ↪ PJHM88 (88 CC)
- ↪ PJHM125 (125 CC)
- ↪ PJHM140 (140 CC)
- ↪ PJHM150CRF (150 CC)
- ↪ PJHM150KLX (150 CC TYPE KLX)

€ 15

€ 15

€ 16

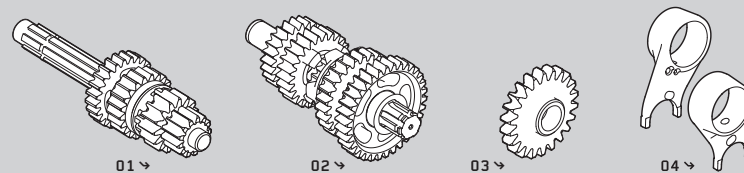

ARBRE BOÎTE PRIMAIRE COMPLET Ø 12 CÔTÉ ALLUMAGE Ø 14 CÔTÉ EMBR. LIFAN LONG. 155mm/ YX LONG. 153,5mm
COMPLETE MAIN BOX SHAFT Ø 12 IGNITION SIDE & Ø 14 CLUTCH SIDE LIFAN LENGTH 155mm/ YX LENGTH 153,5mm

- 01 ↪ 23600/152FMH (LIFAN)
- 01 ↪ E13K030 (YX)
- 01 ↪ A00K030 (88/ 125 SEMI-AUTO ET 125 POINT MORT)

€ 49

ARBRE BOÎTE SECONDAIRE COMPLET Ø 17 CÔTÉ PSB LIFAN Ø 14 CÔTÉ ALLUMAGE/ YX Ø 15 CÔTÉ ALLUMAGE
COMPLETE SECONDARY BOX SHAFT Ø 17 PSB SIDE LIFAN Ø 14 IGNITION SIDE/ YX Ø 15 IGNITION SIDE

- 02 ↪ 23700/152FMH (LIFAN)
- 02 ↪ E13K040 (YX)
- 01 ↪ A00K040 (88/ 125 SEMI-AUTO ET 125 POINT MORT)

€ 49

PIGNON INTERMÉDIAIRE EMBRAYAGE
INTERMEDIATE CLUTCH SPROCKET

- 03 ↪ 208-12-23N (YX : ÉPAISSEUR/ THICKNESS 14mm)

€ 12

JEU DE FOURCHETTES DE BOÎTE RENFORCÉE
REINFORCED GEARBOX FORK

- 04 ↪ FBR

€ 39

EMBRAYAGE CLUTCH



COURONNE D'EMBRAYAGE 88/125 SEMI-AUTO
CLUTCH SPROCKET 88/125 SEMI-AUTO

→ 22610L

€ 20



DISQUE D'EMBRAYAGE YX
YX CLUTCH PLATE

01 → 22330/152FMH (GARNI/ FRICTION) € 6
02 → 22341/152FMH (LISSE/ SMOOTH) € 4



EMBRAYAGE COMPLET DÉMARRAGE AU POINT MORT
START 2012-13
COMPLETE CLUTCH NEUTRAL START
START 2012-13

→ EC

€ 60



EMBRAYAGE COMPLET POUR DÉMARRAGE EN PRISE
COMPLETE CLUTCH FOR KICKSTARTER ENGINE

→ 22100/152FMH

€ 82



EMBRAYAGE COMPLET 88/125 SEMI-AUTO
COMPLETE CLUTCH 88/125 SEMI-AUTO

→ 21100L

€ 60



JOINT SPY SÉLECTEUR
OIL SEAL SHAFT

01 → 24190/152FMH

€ 6

JOINT SPY KICK
KICKSTARTER OIL SEAL

02 → F001C015 (KLX: 16X28X7)
02 → F05C085 (CRF: 16X24X5)
02 → 27190/152FMH (Ø 13mm) € 6

JOINT SPY PSB
OIL SEAL FOR COUNTERSHAFT SPROCKET

03 → 23790/152FMI (Ø 20 - 20/30/4.5)
03 → 23790/152FMH (Ø 17 - 17/29/5) € 6

JOINT SPY TIGE COMMANDE EMBRAYAGE
CLUTCH CONTROL OIL SEAL

04 → 22840/152FMH € 6

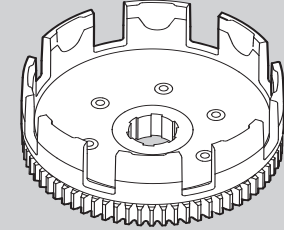

CLOCHE D'EMBRAYAGE
CLUTCH BELL

→ 22110/152FMH

€ 49

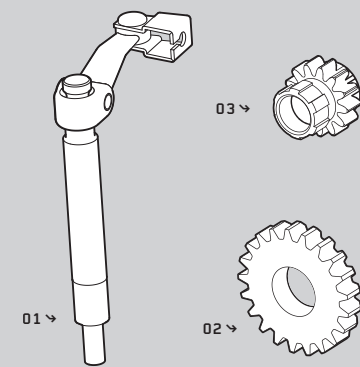

TIGE COMMANDE EMBRAYAGE
PUSH ROD

01 → 22810/152FMH € 15

PIGNON DE KICK
KICKSTARTER SPROCKET YX

02 → 27151/152FMH (LIFAN)
02 → 208K025 (YX) € 12

PIGNON CLOCHE EMBRAYAGE
CLUTCH BELL SPROCKET

03 → 27231/152FMH (LIFAN)
03 → 208-12-25 (YX) € 12





CARTER D'EMBRAYAGE (125CC)
CLUTCH COVER FOR 125CC ENGINE

- D01A034-EC (125 P)
- 11310/1P52FMK (SEMI-AUTO)
- 11310/152FMI (DÉMARAGE EN PRISE)

€ 69



CARTER EMBRAYAGE 150 TYPE CRF OU KLX
CLUTCH COVER 150 TYPE CRF OU KLX

- 216A034 (TYPE CRF KICK Ø 16)
- 2103A034 (TYPE KLX KICK Ø 16)

€ 99



DEMI CARTER EMBRAYAGE 88/ 125
HALF CLUTCH COVER 88/ 125

- RCSC-BK

€ 25

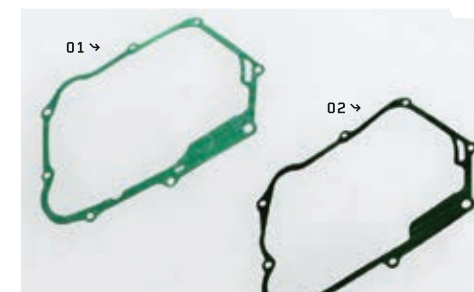

JOINTS DE CARTER D'EMBRAYAGE
ENGINE CLUTCH COVER GASKET

- E041B002 (START/ PILOT 125)
- 11319/152FHM (125 - 140 - 150CRF)

€ 9



**↙ KITS DRESS UP
DRESS UP KITS**

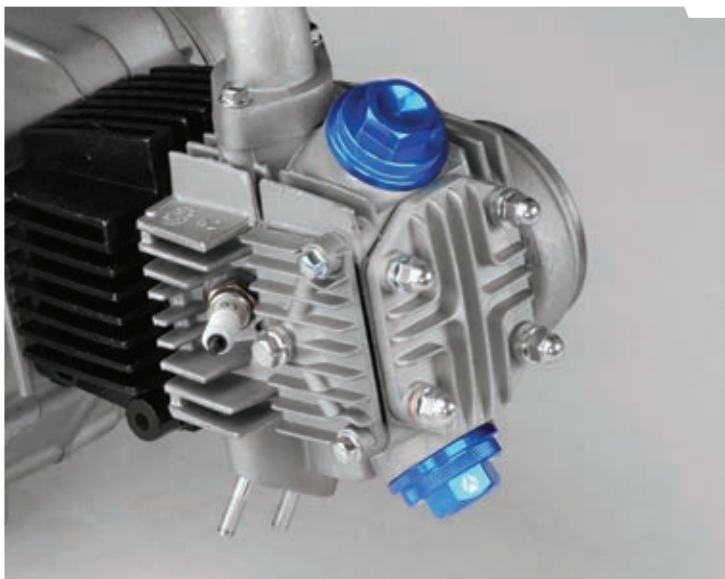

FACTORY
SPECIAL PARTS
YCF RACING



FACTORY
SPECIAL PARTS
YCF RACING

PAIRE DE CACHE SOUPAPE POUR 88/ 125 SEMI-AUTO/ 125 POINT MORT
ROUGE/ BLEU/ NOIR/ ORANGE/ VERT

PAIR OF VALVE COVER 88/ 125
RED/ BLUE/ BLACK/ ORANGE/ GREEN

CACHE FILTRE À HUILE POUR 150 CRF/ KLX
ROUGE/ BLEU/ NOIR/ ORANGE/ VERT

OIL FILTER COVER 150 CRF/ KLX TYPE
RED/ BLUE/ BLACK/ ORANGE/ GREEN

→ VC88 + COLOR (X2)

€ 25

→ OFCCR + COLOR

€ 29

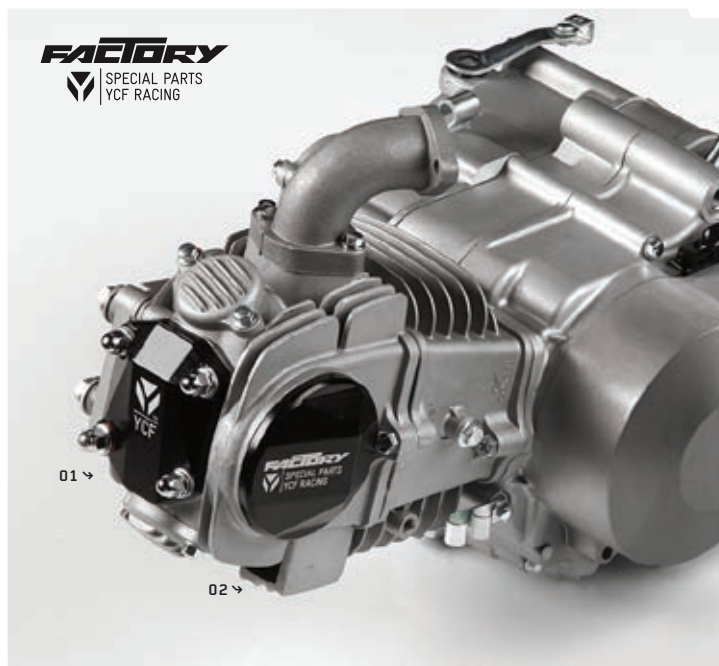
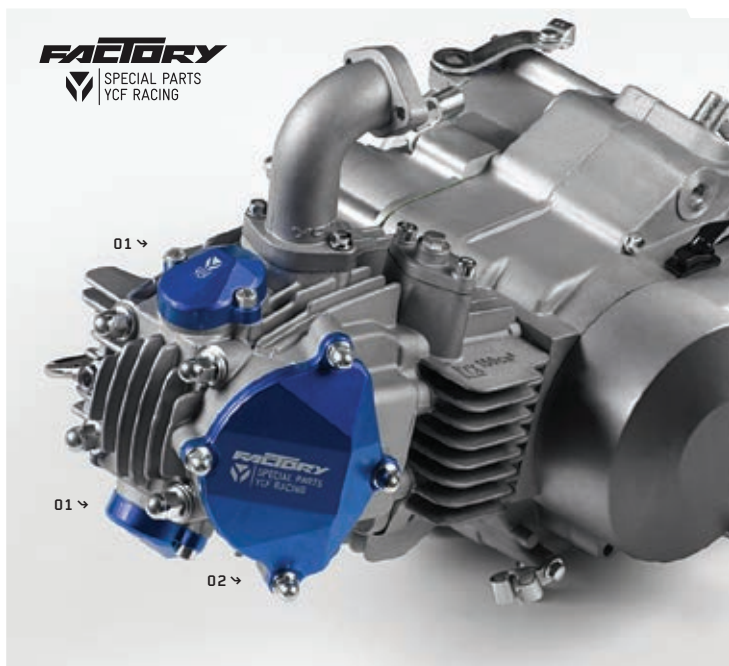

PAIRE DE CACHES SOUPAPE KLX 150
ROUGE/ BLEU/ NOIR/ ORANGE/ VERT
 PAIR OF VALVE COVER KLX 150
 RED/ BLUE/ BLACK/ ORANGE/ GREEN

01 → VCKLX + COLOR

€ 29

CACHE CULASSE KLX 150
ROUGE/ BLEU/ NOIR/ ORANGE/ VERT
 CYLINDER HEAD COVER KLX 150
 RED/ BLUE/ BLACK/ ORANGE/ GREEN

02 → CAMCKLX + COLOR

€ 29



CACHE YX/ LIFAN
ROUGE/ BLEU/ NOIR/ ORANGE/ VERT
 COVER YX/ LIFAN
 RED/ BLUE/ BLACK/ ORANGE/ GREEN

01 → CAMC + COLOR

€ 19

CACHE CDI YX/ LIFAN
ROUGE/ BLEU/ NOIR/ ORANGE/ VERT
 CDI COVER YX/ LIFAN
 RED/ BLUE/ BLACK/ ORANGE/ GREEN

02 → CDIC + COLOR

€ 25

CARBURATEURS CARBURETORS

NIBBI

**NEW
2021**



CARBURATEUR NIBBI NIBBI CARBURATOR

- 01 → PE18FL POUR MOTEUR 88cc € 59
- 02 → PE19FL POUR MOTEUR 125/150cc € 59
→ PE24SP (SM125/SM150) € 59
- 03 → PE28SP POUR MOTEUR 190cc € 119

GICLEUR NIBBI CARBURATEUR PE GICLEUR PRINCIPAL / MAIN JET 88/90/92/95/98/100/102/105/108/110/112/115/118/120/122/125/128/130/132/135

04 → LK-PE + TAILLE/ SIZE € 7

GICLEUR NIBBI CARBURATEUR PWK GICLEUR PRINCIPAL / MAIN JET 98/100/102/105/108/110/112/115/118/120/122/125/128/130/132/135/138/140/142/145/148

05 → LK-PWK + TAILLE/ SIZE € 7

GICLEUR NIBBI CARBURATEUR PZ GICLEUR PRINCIPAL / MAIN JET 70/72/75/78/80/82/85/88/90/92/95/98/100

06 → LK-PZ + TAILLE/ SIZE € 7

GICLEUR NIBBI CARBURATEUR PE/PWK GICLEUR RALENTI / SLOW JET 30/32/35/38/40/42/45/48/50/52/55

07 → LK-FLK + TAILLE/ SIZE € 7

GICLEUR NIBBI CARBURATEUR PZ GICLEUR RALENTI / SLOW JET 30/32/35/38/40

08 → LK-FLKZ + TAILLE/ SIZE € 7



CARBURATEUR YCF 50 YCF 50 CARBURATOR

→ YC50-20-31 € 69



CARBURATEUR KEIHIN® PE28mm PE28mm KEIHIN® CARBURATOR

→ 85707 € 179

MIKUNI



VIS DE CUVE MIKUNI® MIKUNI® TANK SCREW

01 → 16007L € 7

VIS RICHESSE + RESSORT MIKUNI® MIKUNI® NEEDLE VALVE + SPRING

02 → 16005L € 7

VIS RALENTI + RESSORT MIKUNI® MIKUNI® IDLE SCREW + SPRING

03 → 16006L € 7

GICLEUR RALENTI MIKUNI® 10/ 15/ 17,5/ 20/ 22,5/ 25 MIKUNI® SLOW JET

04 → GICLEUR + TAILLE/ SIZE € 7

GICLEUR PRINCIPAL MIKUNI® 85/ 90/ 92,5/ 95/ 97,5/ 100/ 102,5/ 105/ 107,5/ 110/ 115/ 120 MIKUNI® MAIN JET

05 → GICLEUR + TAILLE/ SIZE € 7

POINTEAU CARBURATEUR CARBURETOR FLOAT NEEDLE

- 06 → FLON-50A (YCF50A)
- 07 → FLON-CARBU22 (MIKUNI® 22)
- 08 → 16008L (MIKUNI® 26) € 12

AIGUILLE CARBURATEUR MIKUNI® MIKUNI® CARBURETOR NEEDLE

09 → 16004L € 12

JOINT CUVE CARBURATEUR CARBURETOR FLOAT BOWL GASKET

- 10 → 16010L (MIKUNI® 26)
- 11 → SEAL-CARBU22 (MIKUNI® 22)
- 12 → SEAL-PE28 (KEIHIN® PE28)
- 13 → SEAL-50A (YCF 50A) € 6

GICLEUR PRINCIPAL KEIHIN® 115/ 118/ 120/ 122/ 125/ 128/ 130/ 132 KEIHIN® MAIN JET

14 → 99101-357 + TAILLE/ SIZE € 8

GICLEUR RALENTI KEIHIN® 35/ 38/ 40/ 42/ 45/ 48 KEIHIN® SLOW JET

15 → N424-21 + TAILLE/ SIZE € 8



PIPE ADMISSION DAYTONA®
DAYTONA® INLET PIPE

- | | |
|--------------------|------|
| 01 ↪ 86404 (ANIMA) | € 19 |
| ↪ 84387 (DT) | € 30 |

PIPE ADMISSION POUR BOÎTE À AIR
INLET PIPE FOR AIRBOX

- | | |
|------------|------|
| 02 ↪ 17311 | € 16 |
|------------|------|

PIPE ADMISSION POUR BOÎTE À AIR
INLET PIPE FOR AIRBOX

- | | |
|--|------|
| 03 ↪ 17311-2 (POUR/ FOR FACTORY SPII) | € 19 |
| 03 ↪ 17311-4 (POUR/ FOR PILOT 125) | |
| 03 ↪ 17311-5 (POUR/ FOR PILOT 150) | |
| 03 ↪ 17311-6 (POUR/ FOR PE28) | |
| 03 ↪ 17311-3 (POUR/ FOR FACTORY SPIII) | |

JOINT PAPIER PIPE ADMISSION
INLET PIPE PAPER GASKET

- | | |
|---|--------|
| 04 ↪ 17332/152FMH01 (ENTRE LA PIPE D'ADMISSION ET LE CARBURATEUR/
BETWEEN INLET PIPE AND CARBURETOR) | € 2,50 |
| 04 ↪ 17332 (ENTRE LA CULASSE ET LA PIPE D'ADMISSION/
BETWEEN CYLINDER HEAD AND INLET PIPE) | € 2,50 |

CALE PLASTIQUE PIPE ADMISSION
INLET PIPE PLASTIC HOLDER

- | | |
|-------------------|-----|
| 05 ↪ 17331/152FMH | € 6 |
|-------------------|-----|



STARTER AU GUIDON POUR YCF50A
CHOKE LEVER FOR YCF50A

- | | |
|-------------------|------|
| 01 ↪ YC50-0142-01 | € 19 |
|-------------------|------|



MANCHON SOUPLE
FLEXIBLE SLEEVE

- | | |
|---------------------------------|------|
| 01 ↪ 17315 (VM 24) | € 29 |
| 02 ↪ 46758 (POUR/ FOR DAYTONA®) | € 32 |



FILTRES À AIR AIR FILTERS



SURFILTRE À AIR (VENDU SANS FILTRE À AIR)
AIR FILTER PROTECTION (SELL WITHOUT AIR FILTER)

- K130K (POUR FILTRE ORIGINE YCF/ FOR YCF ORIGINAL AIR FILTER)
- K386K (POUR/ FOR TWIN AIR)

€ 19



CAGE DE FILTRE À AIR
AIR FILTER CAGE

- 01 → YC110-08-012
- 02 → YC110-08-013

€ 6
€ 10

MANCHON DE BOÎTE À AIR YCF
YCF AIRBOX SLEEVE

- 03 → YC110-08-0171 (Ø 49 POUR/ FOR KEHIN® PE28)
- 03 → YC110-08-017 (Ø 40)
- 03 → YC110-08-0173 (PILOT 125 2015-2020)
- 03 → YC110-08-0174 (PILOT 150 2016-2020/ SM150 2016-2020)

€ 10



- 01 →
- 02 →
- 03 →

FILTRE À AIR MOUSSE
FOAM AIR FILTER

- 01 → TA-158430 (POUR/FOR AIR BOX PILOT/ FACTORY/ BIGY) € 20
- 02 → TA-158432 (Ø 40mm POUR/ FOR MIKUNI® 26mm) € 25
- 03 → TA-158431 (Ø 50mm POUR/ FOR KEIHIN® 28mm) € 25



- 01 →
- 02 →
- 03 →



→ PIPE ADMISSION ADÉQUATE, VOIR PAGE 125
→ SUITABLE INLET PIPE, CHECK PAGE 125

BOÎTE À AIR
AIRBOX

- 01 → YC110-0801-07 (POUR/ FOR PILOT 125 & 150, 2015-21) € 49
- 02 → YC110-08-02 (POUR/ FOR FACTORY 2012-21)
- 03 → YC110-0801-09 (POUR/ FOR LITE/ START)



- 01 →
- 02 →
- 03 →

FILTRE À AIR MOUSSE
FOAM AIR FILTER

- 01 → YC110-0802-03 (POUR/ FOR CARBU 22 mm)
(POUR FOR LITE/ START 88) € 22
- 02 → YC110-0802-10 (POUR/ FOR CARBU 26MIKUNI/
NIBBI PE19FL/ PE24SP)(POUR FOR LITE/ START
125/ SM 125/150) € 22
- 03 → YC110-0802-05 (POUR/ FOR CARBU KEIHIN/
NIBBI PE 28 mm) € 24



FILTRE À AIR EN MOUSSE POUR BOÎTE À AIR
FOAM AIR FILTER FOR AIR BOX

- YC110-0817-03
(PILOT 2016-21/ FACTORY 2012-21/ BIGY) € 15

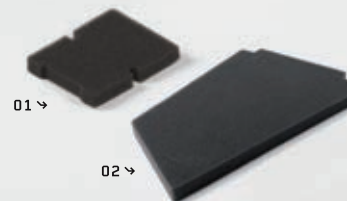

- 01 →
- 02 →

FILTRE À AIR EN MOUSSE POUR BOÎTE À AIR
FOAM AIR FILTER FOR AIR BOX

- 01 → YC50-0802 (POUR/ FOR YCF 50) € 6
- 02 → YC110-0817-02 (POUR/ FOR LITE/ START) € 12

ÉCHAPPEMENTS EXHAUSTS



SPECIAL PARTS
YCF RACING

LAINES DE ROCHE POUR SILENCIEUX
MUFFLER ROCKWOOL FOR NOISE REDUCTION

01 → LR1 € 10

BRIDE DE POT POUR SILENCIEUX
MUFFLER SPARK ARRESTOR

02 → YC110-13-30 € 30

JOINT DE POT
EXHAUST SEAL

03 → 18291/152FMH € 1

EMBOUT DE POT 88/RS/RSP/SM 2011-2020
EXHAUST END FOR 88/RS/RSP/SM 2011-2020

04 → YC110-13-32 € 19

RESSORT DE POT AVEC CAOUTCHOUC
EXHAUST SPRING WITH RUBBER

05 → YC110-13-21 € 3

EMBOUT SILENCIEUX POUR LAVAGE MOTO
WASH MUFFLER PLUG

06 → EEP-BL € 5

BRIDE DE POT
SPARK ARRESTOR

07 → BP30BLACK (Ø 30) € 19

EMBOUT DE POT CRD®
CRD® EXHAUST END

08 → YC110-13-31 € 19



ATTACHE SILENCIEUX ROND POUR R START 09-10
ROUND MUFFLER CLAMP FOR R START 09-10

01 → YC110-13-01 € 15

ATTACHE SILENCIEUX CRD®
CRD® MUFFLER CLAMP

02 → YC110-13-03 € 15

ATTACHE SILENCIEUX OVALE (88, RS, RSP, SM 2011-21)
OVAL MUFFLER CLAMP (88, RS, RSP, SM 2011-21)

03 → YC110-13-04 € 15



ÉCHAPPEMENTS RACING RACING EXHAUSTS



FACTORY
SPECIAL PARTS
YCF RACING

LIGNE ÉCHAPPEMENT COMPLETE RACING SIMPLE
COMPLETE RACING EXHAUST SINGLE

- YC110-136-07-BK (POUR/ FOR PILOT/ SM150)
- YC110-139-07-BK (POUR/ FOR FACTORY)
- YC110-140-01-BK (POUR/ FOR BIGY)

€ 299



EMBOUT DE POT FACTORY
FACTORY EXHAUST END

→ YC110-13-35

€ 19



RESSORT DE POT FACTORY
FACTORY EXHAUST SPRING WITH RUBBER

→ YC110-13-22

€ 3



FACTORY
SPECIAL PARTS
YCF RACING

SILENCIEUX RACING FACTORY
FACTORY RACING EXHAUST

→ YC110-13014-03BK

€ 149



FACTORY
SPECIAL PARTS
YCF RACING

ATTACHE SILENCIEUX FACTORY
FACTORY MUFFLER CLAMP

→ YC110-1307-03

€ 19



FACTORY
SPECIAL PARTS
YCF RACING

LIGNE ÉCHAPPEMENT COMPLETE RACING DOUBLE
COMPLETE RACING EXHAUST TWIN

- YC110-136-08-BK (POUR/ FOR PILOT/ SM150)
- YC110-139-08-BK (POUR/ FOR FACTORY)
- YC110-140-02-BK (POUR/ FOR BIGY)

€ 399



COLLECTEUR RACING
RACING SEWER

- YC110-1302-22 (PILOT)
- YC110-1302-13 (SP3)
- YC110-1308-01 (BIGY)

€ 99



Y DU COLLECTEUR RACING DOUBLE
DOUBLE RACING SEWER Y

- YC110-1302-23 (PILOT)
- YC110-1302-14 (SP)
- YC110-1308-03 (BIGY)

€ 89



PARTIE INTERMÉDIAIRE COLLECTEUR RACING
RACING SEWER INTERMEDIATE PART

- YC110-1302-24 (PILOT)
- YC110-1302-15 (SP)
- YC110-1308-02 (BIGY)

€ 49



ÉCHAPPEMENT YCF ANTI-BRUIT (GAMME FACTORY)
SPARK ARESTOR YCF EXHAUST (FACTORY RANGE)

- YC110-139-03 (POUR/ FOR FACTORY SP2 & SP3)
- YC110-139-09 (POUR/ FOR BIGY)

€ 249



COLLECTEUR ÉCHAPPEMENT FACTORY
FACTORY EXHAUST SEWER

- YC110-13028-01 (SP3)
- YC110-13028-03 (BIGY 190)
- YC110-13028-05 (PILOT)
- YC110-13028-02 (SP3 DOUBLE)
- YC110-13028-04 (BIGY DOUBLE)
- YC110-13028-06 (PILOT DOUBLE)

€ 129

€ 159



ÉCHAPPEMENT GROS DIAMÈTRE AVEC BRIDE DE POT AMOVIBLE
LARGE DIAMETER EXHAUST SUPPLIED WITH REMOVABLE SPARK ARRESTOR

- YC110-136-GY (POUR/ FOR START)
- YC110-136-03-GY (POUR/ FOR PILOT/ SM 150)
- YC110-139-10 (POUR/ FOR BIGY)

€ 99



COLLECTEUR ÉCHAPPEMENT BIGY
BIGY EXHAUST SEWER

- YC110-1302-20 (125/150 BIGY MX)
- YC110-1302-26 (190 BIGY ZE)
- YC110-1302-28 (150 BIGY FACTORY)

€ 69

FILTRES & RADIATEURS FILTERS & COOLERS



KIT COMPLET RADIATEUR HUILE
COMPLETE OIL COOLER KIT

- YC110-2302 (YX 150 TYPE KLX DIAM 10/10)
- YC110-2307 (DAYTONA®/ YX TYPE CRF)
- YC110-2305 (AFTERMARKET DIAM 10/10)

€ 99



KIT RADIATEUR UNIVERSEL ADAPTABLE SUR TOUS LES MODÈLES
UNIVERSAL OIL COOLER KIT ADAPTABLE TO ALL MODELS

- YC110-2306 (VENDU AVEC 6 DURITES/ SOLD WITH 6 HOSES)

€ 199

**NEW
2021**



PETITE JAUGE HUILE BLEU/ ROUGE/ ORANGE/ NOIR/ VERT
LITTLE OIL DIPSTICK BLUE/ RED/ ORANGE/ BLACK/ GREEN

- 01 → JH01 (SM150/ FACTORY/ BIGY FACTORY 150/190) € 17



FILTRE À HUILE
OIL FILTER

- 01 → 216E010

€ 16

ÉPURATEUR D'HUILE ALLÉGÉ
LIGHTED OIL PURIFIER

- 02 → 208G082

€ 25



DURITE HUILE RADIATEUR
OIL COOLER HOSE

- YC110-23-01 (2007)
- YC110-23-013 (L=400MM)
- YC110-23-014 (L=285MM/ Ø=10)
- YC110-23-015 (L=260MM/ Ø=8/8)
- YC110-23-016 (L=125MM/ Ø=10/8)
- YC110-23-017 (L=290MM/ Ø=10/10)
- YC110-23-0003 (L=110MM/ Ø=10/8)
- YC110-23-02 (2007)
- YC110-23-022 (L=490MM)
- YC110-23-023 (L=395MM/ Ø=10/8)
- YC110-23-024 (L=495MM/ Ø=10/8)
- YC110-23-025 (L=360MM/ Ø=10/10)

€ 19

**SPECIAL PARTS
YCF RACING**



JAUGE HUILE ROUGE/ NOIRE/ BLEUE/ ORANGE/ VERTE
OIL DIPSTICK RED/ BLACK/ BLUE/ ORANGE/ GREEN

- JH + COLOR (LITE/ START/ PILOT/ BIGY 125/150 MX)

€ 17

**SPECIAL PARTS
YCF RACING**



BOUCHON VIDANGE AIMANTÉ
ROUGE/ BLEU/ NOIR/ ORANGE/ VERT
MAGNETIC DRAIN PLUG
RED/ BLACK/ BLUE/ ORANGE/ GREEN

- 01 → BVE1 + COLOR

€ 9

HUBLOT À HUILE
OIL LEVEL SIGHT GLASS

- 02 → D00C027

€ 10



ALLUMAGE IGNITION



FAISCEAU ÉLECTRIQUE WIRING HARNESS

- 01 → YC110-1501 (NON ÉTANCHANCHE/ NO WATERPROOF)
→ YC110-1501-12 START SE 88/125 (CONNECTEUR ÉTANCHE/ WATERPROOF CONNECTION) € 15
- YC110-1501-08 BIGY (DÉMARREUR ÉLECTRIQUE/ ÉLECTRIC START/ CONNECTEUR ÉTANCHE/ WATER-PROOF CONNECTION) € 19
- YC110-1501-09 BIGY (SANS DÉMARREUR/ WITHOUT ÉLECTRIC START CONNECTEUR ÉTANCHE/ WATERPROOF CONNECTION) € 19
- YC110-1501-11 (LITE/START/PILOT/SP) (SANS DÉMARREUR/ WITHOUT ÉLECTRIC START CONNECTEUR ÉTANCHE/ WATERPROOF CONNECTION) € 15

BOÎTIER CDI CDI BOX

- 02 → YC110-1503 € 15

BOBINE HAUTE TENSION HIGH TENSION IGNITION COIL

- 03 → YC110-1504 € 15

BATTERIE BATTERY

- 04 → YC110-1507-02 (88 & 125SE) € 39
- 04 → YC110-1507-04 (190ZE)



CDI RACING CDI RACING

- YC110-1503-01 € 29



ALLUMAGE YCF 50A YCF 50A IGNITION

- 01 → YC50-0021 (CONTACTEUR CLÉ/ KEY SWITCH) € 10
- 02 → YC50-1502 (RÉGULATEUR DE TENSION/ TENSION REGULATOR) € 15
- 03 → YC50-1510 (RELAIS DÉMARREUR/ STARTER RELAY) € 15
- 04 → YC50-1507-01 (BATTERIE POUR 50A/ BATTERY FOR 50A) € 35
- 05 → YC50-1514 (CHARGEUR BATTERIE/ BATTERY CHARGER) € 35
- 06 → YC110-0021-02 (CONTACTEUR CLÉ ÉTANCHE/ WATERPROOF KEY SWITCH) € 15



ALLUMAGE MAGNETO

- 01 → RRG (ALLÉGÉ/ LIGHTWEIGHT) € 99
- 02 → 31100/152FMH € 49
- 03 → 31210/152FMH € 30





COUPE CIRCUIT
REMOTE SWITCH

- 01 → YC110-0105-01 (SWITCH ON/OFF) € 15
- 02 → YC110-0105 (SWITCH) € 20
- 03 → YC110-0105-16 (SWITCH-WATERPROOF) € 20
- 04 → YC110-0105-05 (SWITCH + LEASH) € 20

COMPTEUR D'HEURE & SUPPORT
HOUR METER & SUPPORTING PLATE

- 05 → STANDCOMPT-H (SUPPORT/ SUPPORTING PLATE) € 9
- 06 → COMPT-H (COMPTEUR D'HEURE/ HOUR METER) € 29
- 07 → COMPT01-H (COMPTEUR D'HEURE VIBRATION/ HOUR METER VIBRATION) € 39



→ FOR 50 ONLY

COUPE CIRCUIT À DISTANCE
VENDU AVEC 2 TÉLÉCOMMANDES
DISTANCE ENGINE CUT OFF
SOLD WITH 2 REMOTES CONTROL

→ YC50-1518 € 79



BOUGIE & ANTI PARASITE
SPARK PLUG & SPARK PLUG CAP

- 01 → 221D021 (4 SOUPAPES YX/ YX 4 STROKE) € 39
- 02 → 34210/152FMH (CR7HS)
- 03 → 34210/D8EA (D8EA 125 R START 2012-13)
- 04 → YC110-1505 (CAP/ ANTI PARASITE) € 6



DAYTONA® ANIMA® RACING PARTS / PIÈCES RACING



CHAÎNE DE DISTRIBUTION RENFORCÉE D.I.D
D.I.D REINFORCED TIMING SPROCKET

→ 87577 € 65



PISTON FORGÉ POUR ANIMA®
FORGED PISTON FOR ANIMA®

→ 87173 (150cc) € 99
→ 88599 (190cc)



KIT ARBRE À CAME RACING
RACING CAMSHAFT KIT

→ 87583 € 249

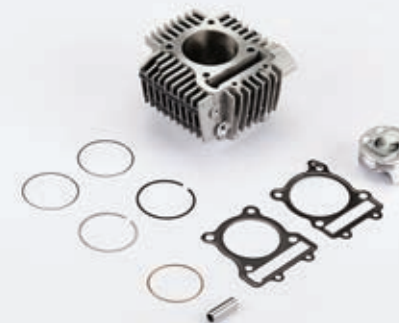

KIT 212cc
212cc KIT

→ 88011 € 319
→ 88976 € 79



KIT ALLUMAGE F-SM RÉGLABLE
MULTI CURVES ROTOR KIT

→ 87235 € 259



**NEW
2021**

**COUVRE FILTRE HUILE ANIMA® BLEU/ ROUGE/
ORANGE/ NOIR/ VERT**
ANIMA® OIL FILTER COVER BLUE/ RED/ ORANGE
BLACK/ GREEN

→ OFCDAYT-COLOR € 29



COUVRE CULASSE ANIMA® RACING
ANIMA® RACING CYLINDER HEAD COVER

→ 87994 € 59



PIPE ADMISION ANIMA® 15°
INTAKE MANIFOLD ANIMA® 15°

→ 88253 € 59



CHAÎNE DE DÉMARREUR RENFORCÉE DID
STARTER CHAIN DID

→ 89522 € 49

DAYTONA®

DAYTONA® ANIMA® 2,0 150/190cc (4 VALVES) GENUINE PARTS/ PIÈCES D'ORIGINES

DAYTONA

SEQ #	PART #	DESCRIPTION	QTY	(€) UNIT PRICE
1	86461	BOLT, CROSS RECESSED COUNTERSUNK M6x15	2	1,00
2	86464	BOLT, HEXAGON FLANGE M6x25	2	1,00
3	86472	BOLT, HEXAGON FLANGE M6x32	1	1,00
4	86427	BOX, CDI, DESIGNATION FDX	1	119,00
4	88130	BOX, CDI FSM (12900 RPM MAX)	1	69,00
5	86426	COIL, IGNITION	1	15,00
6	86373	COVER, MAGNET	1	39,00
7	86431	FLYWHEEL MAGNET COMP FDX	1	79,00
7	88127	FLYWHEEL MAGNET COMP FSM	1	79,00
8	86452	NUT, MAGNET M12	1	2,00
9	86479	O-RING, Ø6,5xØ1,8	2	2,00
10	86430	STATOR ASSY, DESIGNATION FDX	1	89,00
10	88129	STATOR ASSEMBLY FSM	1	89,00
11	86428	WIRE HERNESS	1	39,00

DAYTONA

SEQ #	PART #	DESCRIPTION	QTY	(€) UNIT PRICE
1	84678	BOLT, CROSS RECESSED COUNTERSUNK M6x30	1	1,00
2	84677	BOLT, CROSS RECESSED COUNTERSUNK M6x35	2	1,00
3	84676	GASKET, PUMP OIL	1	3,00
4	83747	PIN, DOWEL Ø8xØ6,3x12	2	1,00
5	86382	PUMP, OIL ASSY	1	49,00

DAYTONA

SEQ #	PART #	DESCRIPTION	QTY	(€) UNIT PRICE
1	86446	BOLT, BANJO M10x22,5	2	3,00
2	86362	BOLT, HEXAGON FLANGE M6x105	1	2,00
3	86486	BOLT, HEXAGON FLANGE M6x15	2	3,00
4	86469	BOLT, HEXAGON FLANGE M6x22	2	1,00
5	86485	BOLT, HEXAGON FLANGE M6x28	2	2,00
6	86471	BOLT, HEXAGON FLANGE M6x30	2	1,00
7	86473	BOLT, HEXAGON FLANGE M6x50	2	2,00
8	86474	BOLT, HEXAGON FLANGE M6x55	1	2,00
9	83759	BOLT, HEXAGON FLANGE M6x60	1	2,00
10	86361	BOLT, HEXAGON FLANGE M6x90	1	2,00
11	86376	COVER, CLUTCH	1	120,00
12	86374	COVER, OIL FILTER	1	12,00
13	86377	COVER, SMALL CLUTCH	1	59,00
14	83489	FILTER, OIL	1	16,00
15	86437	GASKET, COVER CLUTCH	1	10,00
16	86476	GASKET, M10	4	2,00
17	86412	HOLDER, CABLE CLUTCH	1	9,00
18	86414	LEVER, CLUTCH COMP	1	35,00
19	86432	O-RING, Ø38,6x2,6	1	2,00
20	86435	O-RING, COVER SMALL CLUTCH	1	5,00
21	86441	OIL SEAL, Ø16xØ26x7	1	6,00
22	86442	OIL SEAL, Ø17xØ10x5	1	6,00
23	86406	OIL THROUGH COMP	2	19,00
24	83747	PIN, DOWEL Ø8xØ6,3x12	4	1,00
25	86386	RULER	1	3,00
26	86413	SPRING, LEVER CLUTCH	1	2,00
27	86375	SPRING, OIL FILTER	1	2,00
28	86475	WINDOW, OIL LEVEL	1	15,00

DAYTONA

ALLUMAGE GENERATOR

ANIMA® 2,0 150/ 190CC

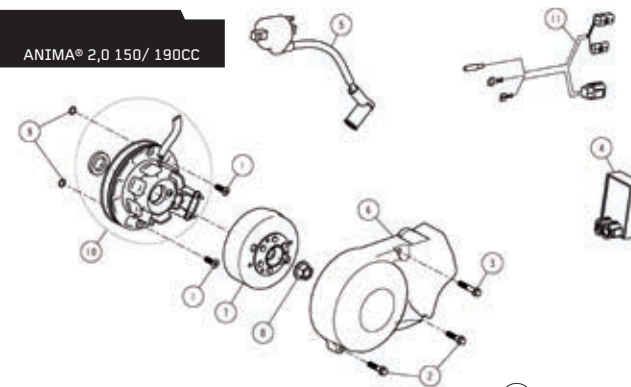

DAYTONA

POMPE À HUILE OIL PUMP

ANIMA® 2,0 150/ 190CC

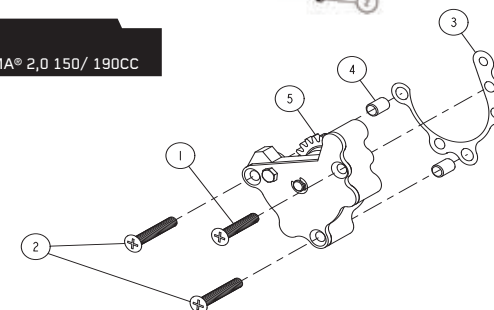

DAYTONA

CARTER EMBRAYAGE COVER CLUTCH

ANIMA® 2,0 150/ 190CC

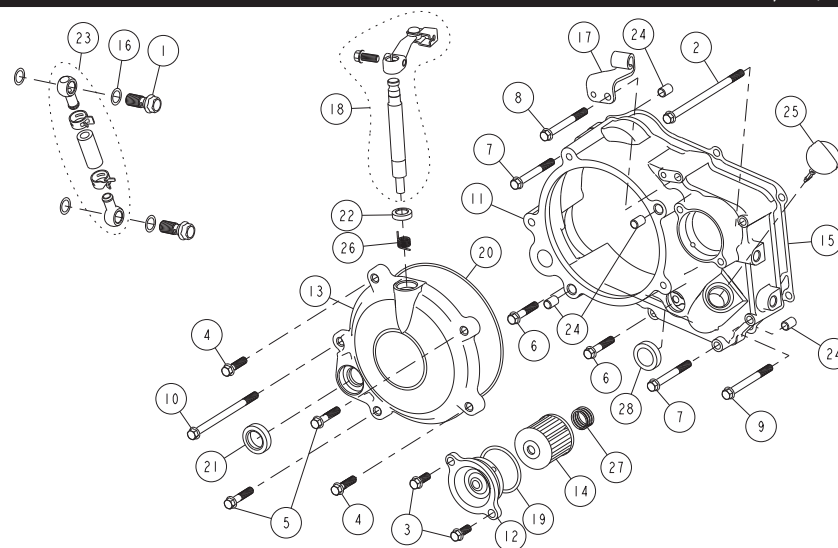

DAYTONA

SEQ #	PART #	DESCRIPTION	QTY	(€) UNIT PRICE
1	86453	CLIP, PIN PISTON	2	2,00
2	86381	CRANK SHAFT ASSY ANIMA 150	1	199,00
3	86620	CRANK SHAFT ASSY ANIMA 190	1	199,00
3	87760	CRANK SHAFT ASSY ANIMA 160	1	199,00
3	89144	CRANK SHAFT ASSY ANIMA 190-5 SPEEDS	1	239,00
4	86383	GEAR, OIL PUMP DRIVE	1	15,00
5	86415	GEAR, PRIMARY DRIVE	1	29,00
6	83768	NUT, SMALL M14	1	3,00
7	86443	OIL SEAL, Ø12xØ20x5t	1	6,00
8	86379	PIN, PISTON Ø14	1	5,00
9	86378	PISTON DT150	1	59,00
10	86621	PISTON DT190	1	65,00
11	86462	RETAINING RING, RTWN22	1	2,00
12	86380	RING SET, PISTON	1	30,00
13	86411	WASHER, SPRING	1	3,00

DAYTONA

PISTON & VILEBREQUIN
PISTON & CRANCK SHAFT

ANIMA® 2,0 150/ 190CC

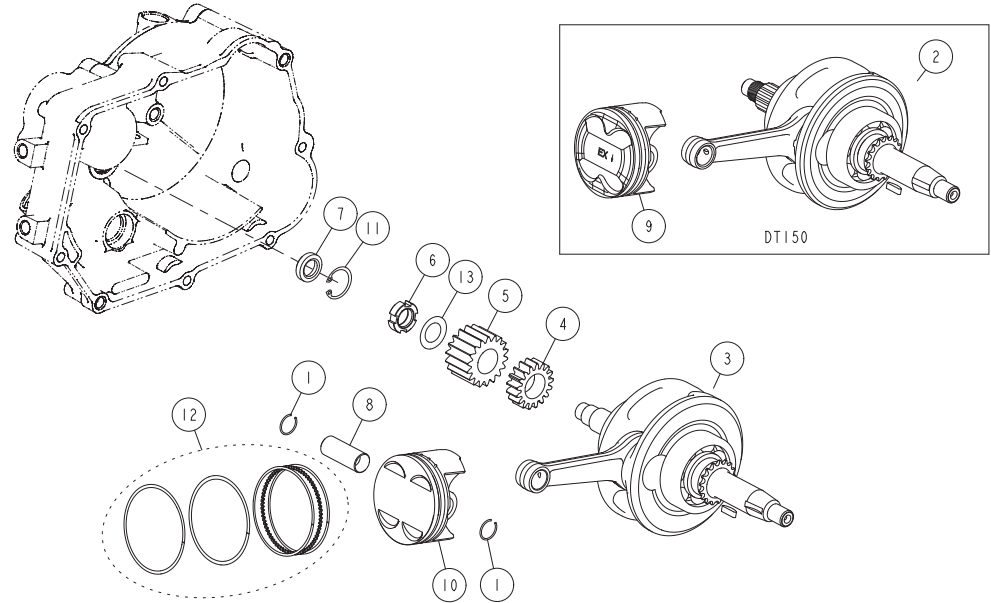

DAYTONA

SEQ #	PART #	DESCRIPTION	QTY	(€) UNIT PRICE
1	86474	BOLT, HEXAGON FLANGE M6x55	1	2,00
2	83761	BOLT, HEXAGON FLANGE M6x65	1	2,00
3	86360	BOLT, HEXAGON FLANGE M6x70	5	2,00
4	86459	BOLT, HEXAGON SOCKET M6x105	2	3,00
5	83755	BOLT, OIL DRAIN M12x15	1	2,00
6	86444	BOLT, STUD A	2	6,00
7	86445	BOLT, STUD B	2	6,00
8	86369	COVER, STRAINER OIL	1	4,00
9	86370	CRANK CASE, LH	1	119,00
9	89143	CRANK CASE, LH, 5 SPEEDS	1	149,00
10	86884	CRANK CASE, RH	1	109,00
10	88848	CRANK CASE, RH, 5 SPEEDS	1	119,00
11	86438	GASKET, CRANKCASE	1	6,00
12	86371	HOSE, BREATHER	1	10,00
13	86451	NUT FLANGE, M8	4	1,00
14	86433	O-RING, Ø30xØ3	1	2,00
15	83720	PIN, DOWELØ10xØ8,4x14	2	2,00
16	86385	SPRING, STRAINER	1	1,00
17	86387	STRAINER, OIL	1	3,00
18	86457	WASHER, GASKET M8	4	2,00
19	83754	WASHER, OIL DRAIN M12	1	5,00

DAYTONA

CARTER
CRANKCASE

ANIMA® 2,0 150/ 190CC

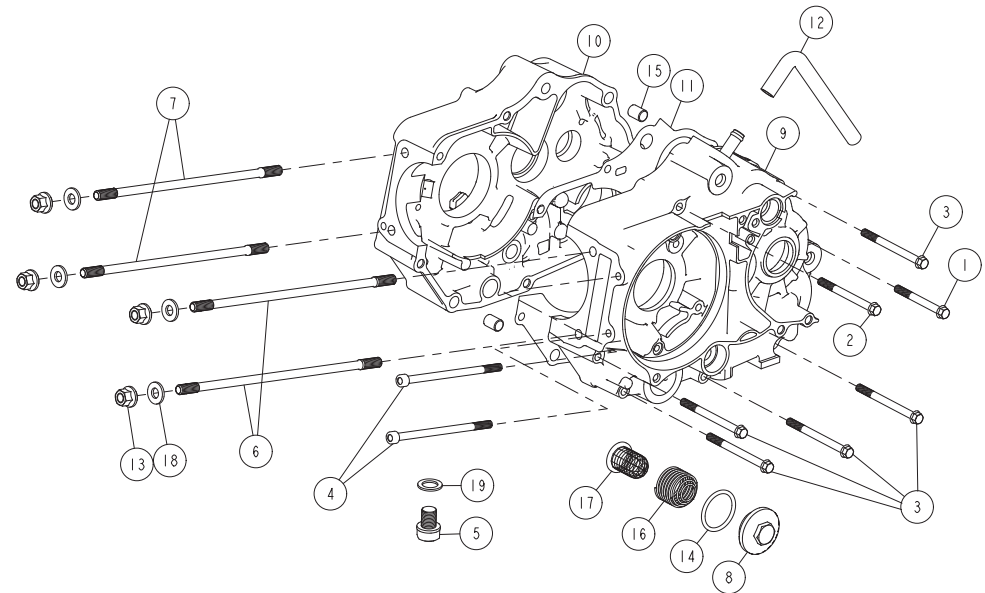

SEQ #	PART #	DESCRIPTION	QTY	(C) UNIT PRICE
1	86448	BOLT, HEXAGON FLANGE M10x16	1	3,00
2	85877	BOLT, HEXAGON FLANGE M6x12	1	1,00
3	86468	BOLT, HEXAGON FLANGE M6x18	6	1,00
4	86466	BOLT, HEXAGON FLANGE M6x25	1	1,00
5	86471	BOLT, HEXAGON FLANGE M6x30	1	1,00
6	83703	BOLT, STUD M6x32	2	2,00
7	86367	COVER, CYLINDER HEAD	1	45,00
8	86366	CYLINDER	1	209,00
9	86436	GASKET, BASE CYLINDER	1	12,00
10	86440	GASKET, HEAD CYLINDER	1	19,00
11	86476	GASKET, M10	1	2,00
12	86405	GASKET, MANIFOLD	1	3,00
13	86439	GASKET, TANSIONER CAM CHAIN	1	3,00
14	86368	HEAD, CYLINDER	1	209,00
15	86404	MANIFOLD, INTAKE	1	19,00
16	86479	O-RING	1	2,00
17	86434	O-RING, COVER HEAD	1	15,00
18	83720	PIN, DOWEL Ø10xØ8,4x14	4	2,00
19	83747	PIN, DOWEL Ø8xØ6,3x12	1	1,00
20	221D021	SPARK PLUG ER9EH	1	39,00
21	86396	TENSIONER, CAM CHAIN COMP	1	25,00
22	86456	WASHER, Ø6,3xØ12x1,5	1	2,00

CULASSE ANIMA®
HEAD CYLINDER

ANIMA® 2,0 150/ 190CC

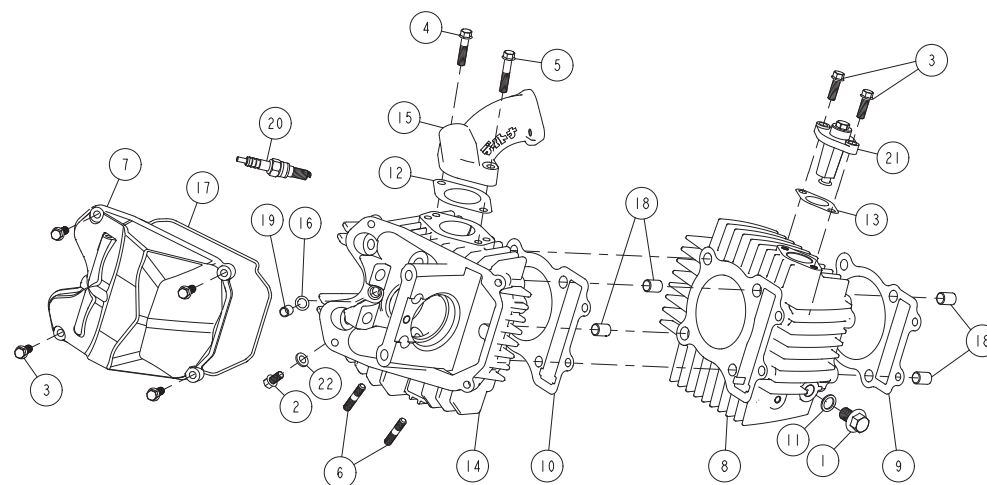

SEQ #	PART #	DESCRIPTION	QTY	(C) UNIT PRICE
1	86481	ARM, ROCKER ROLLER EXHAUST COMP	1	59.00
2	86393	ARM, ROCKER ROLLER INTAKE COMP	1	59.00
3	86460	BOLT, COUNTERSINK M6x15	1	1.00
4	86883	SCREW M6x16	2	1.00
5	86447	BOLT, TENSIONER	1	2.00
6	86878	CAMSHAFT 240Ø ROLLER DECOMP ASM	1	99.00
7	86391	CHAIN, CAMSHAFT DRIVE	1	35.00
8	86402	COTTER, VALVE	8	4.00
9	89681	SHAFT W/WEIGHT,DECOMP,V3	1	49.00
10	86395	GUDE , CHAIN CAMSHAFT	1	20.00
11	86389	PLATE, STOPPER CAM	1	3.00
12	86400	RETAINER, SPRING VALVE	4	5.00
13	86403	SEAL, VALVE STEM Ø4.5	4	6.00
14	86401	SEAT, SPRING VALVE	4	4.00
15	86392	SHAFT, ROCKER	2	5.00
16	87621	SPRING,RETURN DECOMP.	1	2.00
17	86624	SPRING, VALVE	4	16.00
18	86879	SPROCKET, CAMSHAFT DRIVEN	1	15.00
19	87620	PLATE,STOPPER DECOMP.	1	3.00
20	86394	TENSIONER, CAM CHAIN	1	20.00
21	86623	VALVE, EXHAUST Ø21	2	30.00
22	86397	VALVE, INTAKE Ø24.5	2	16.00

DISTRIBUTION
VALVE MECHANISM

ANIMA® 2,0 150/ 190CC

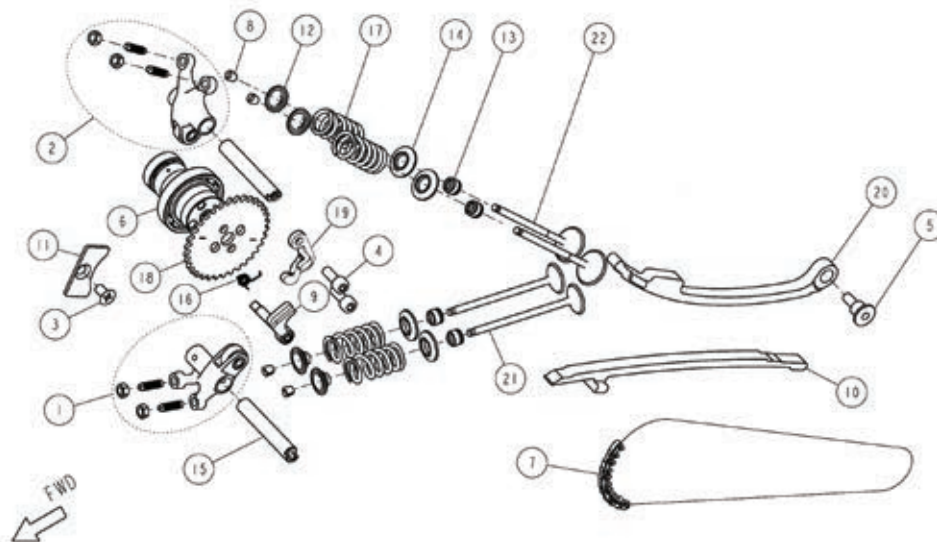

DAYTONA

SEQ #	PART #	DESCRIPTION	QTY	(€) UNIT PRICE
1	83786	BEARING, #6000	1	6,00
2	87619	CLUTCH COMP (FORGED GEAR)	1	179,00
3	86417	GEAR, STARTER DRIVEN 2 13T	1	20,00
4	83768	NUT, SMALL M14	1	3,00
5	83787	PIN, LIFTER CLUTCH	1	20,00
6	86410	WASHER, SPRING Ø24xØ14,2x1,2	1	1,00

DAYTONA®

EMBRAYAGE
CLUTCH

ANIMA® 2,0 150/ 190CC

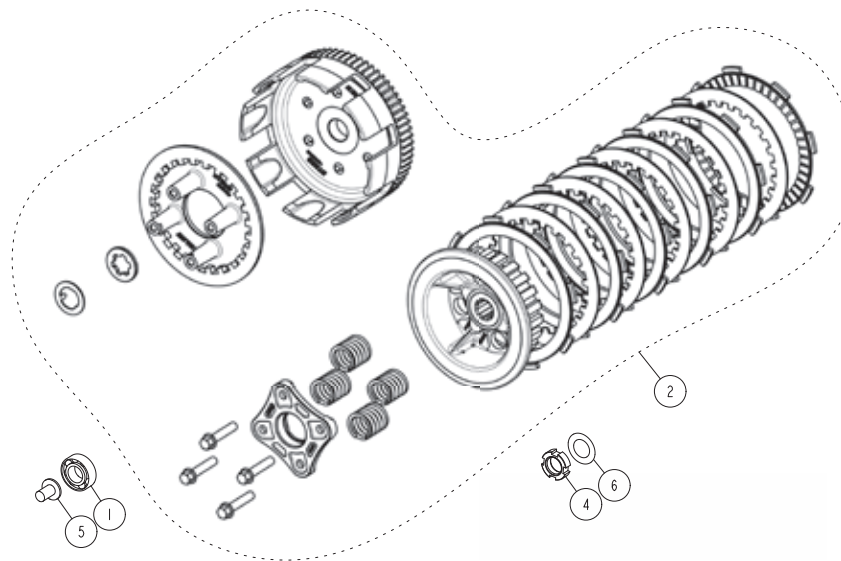

DAYTONA

SEQ #	PART #	DESCRIPTION	QTY	(€) UNIT PRICE
1	83788	BEARING #6001	1	8,00
2	83795	BEARING #6203	2	10,00
3	86454	BEARING NK152712	1	12,00
4	86464	BOLT, HEXAGON SOCKET M6x10	2	1,00
5	86418	GEAR IDLE, STARTER	1	20,00
6	86919	GEAR, COMP,4 SPEED	1	149,00
6	89682	GEAR, COMP 5 SPEED	1	149,00
7	83796	OIL SEAL, Ø29xØ17x5	1	6,00
8	86420	PLATE, FIXING SPROCKET DRIVE	1	6,00
9	86463	RETAINING RING Ø13,6	1	2,00
10	86419	SPROCKET, DRIVE 15T	1	8,00
11	86455	WASHER, Ø22xØ15x0,5	2	1,00

DAYTONA®

BOÎTE DE VITESSE
GEARBOX

ANIMA® 2,0 150/ 190CC

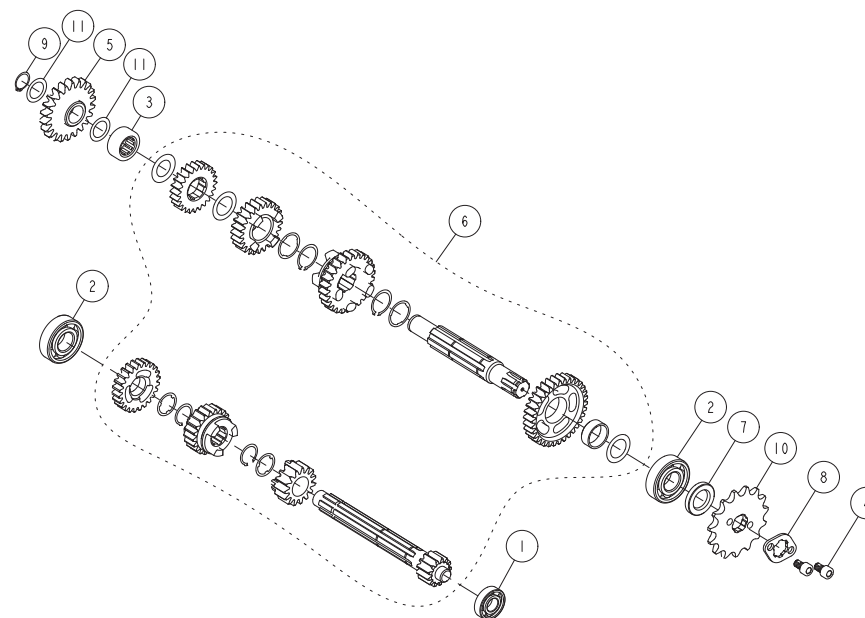

DAYTONA

SEQ #	PART #	DESCRIPTION	QTY	(C) UNIT PRICE
1	86449	BOLT, HEXAGON SOCKET M6	1	2,00
2	85877	BOLT, HEXAGON SOCKET M6x15	1	1,00
3	83833	CONTACT, GEAR INDICATION	1	3,00
4	86421	DRUM, SHIFT N-1-2-3-4 COMP	1	55,00
4	88423	DRUM, SHIFT 5 SPEEDS	1	59,00
6	86422	LEVER, GEAR SHIFT COMP	1	20,00
6	88886	LEVER, GEAR SHIFT COMP 5 GEAR	1	20,00
7	86424	LOCATING PLATE UNIT	1	4,00
8	83837	OIL SEAL, Ø24xØ16x10	1	6,00
9	86480	PIN, LOCATING SHIFT LEVER	1	3,00
10	85876	PLATE, LOCATING SWITCH NEUTRAL	1	1,00
11	86423	SPRING, LOCATING PLATE	1	1,00

DAYTONA

**BOÎTE/ FOURCHETTES
GEARBOX MECHANISM**

ANIMA® 2,0 150/ 190CC

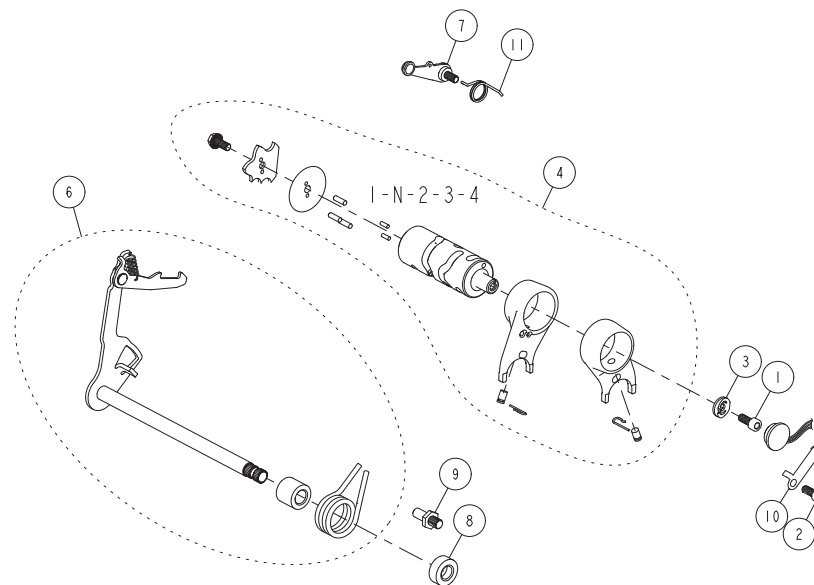

DAYTONA

SEQ #	PART #	DESCRIPTION	QTY	(C) UNIT PRICE
1	86407	KICK STARTER ASM	1	89,00
1	88883	KICK ASSY 5 GEAR	1	69,00

DAYTONA

**KICK
KICK STARTER**

ANIMA® 2,0 150/ 190CC

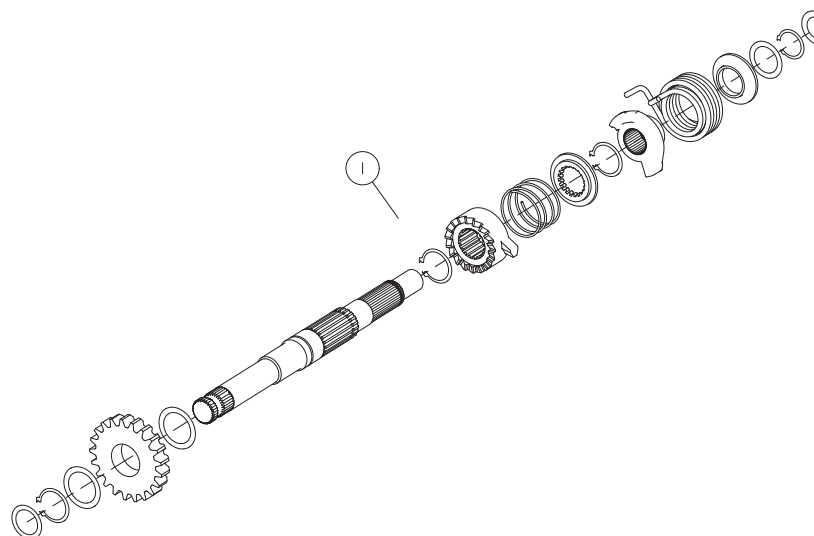

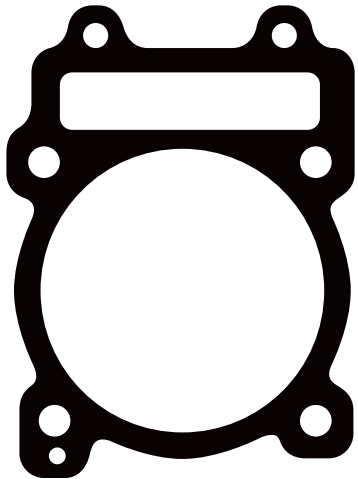

ART DIRECTION

ENCORE STUDIO

GRAPHIC DESIGN

F. ALAUX, T. JUMIN & Q. BRACHET

INDUSTRIAL DESIGN

FRANÇOIS ALAUX FOR YCF MOTORCYCLES

THANKS TO

#111

STEPHANE LE CORRE, CATHERINE HOSSARD & YCF CREW MEMBERS

MIKE ALESSI, MICHAEL HALL , ALEC PERONNARD, ANDRA ILENE BARNETT

COLIN GALIARDO, ZAKERY GALIARDO, RICKY CARMICHAEL

TRACK

OKEFENOKEE, GEORGIA, USA,



WELCOMETOENCORE.COM

PHOTOGRAPHY

ACTION & STUDIO: JEFF KARDAS

PARTS: ANTOINE CADOT

YCF FOUNDERS

DIMITRI BERA & YANNICK COQUARD





TOUT LES MODÈLES PRÉSENTÉS SONT DES MOTOS AUX NORMES CE. VÉHICULE NON HOMOLOGUÉ ET INTERDIT SUR LA VOIE PUBLIQUE. USAGE RÉSERVÉ UNIQUEMENT SUR CIRCUIT FERMÉ ET PRIVÉ. TOUJOURS PORTER UN CASQUE, DES LUNETTES ET DES VÊTEMENTS DE PROTECTIONS. NE JAMAIS MONTER EN TANT QUE PASSAGER.

ALL MODELS PRESENTED MEET EC STANDARDS. VEHICLE NOT AUTHORIZED ON THE PUBLIC WAYS. RESERVED ONLY ON CLOSED AND PRIVATE TRACKS. ALWAYS WEAR HELMET, GOGGLE AND ADAPTED PROTECTIONS. NEVER RIDE WITH A PASSENGER.

YCF SE RÉSERVE LE DROIT DE MODIFIER LES CARACTÉRISTIQUES ET LES PRIX DE SES PRODUITS. TOUTE REPRODUCTION MÊME PARTIELLE DE CE CATALOGUE DOIT FAIRE L'OBJET D'UN ACCORD PRÉALABLE AVEC YCF.

YCF RESERVES THE RIGHT TO MODIFY THE SPECIFICATIONS OR THE PRICES OF ITS PRODUCTS. ANY REPRODUCTION IN WHOLE OR IN PART OF THIS CATALOGUE REQUIRES THE PRIOR AGREEMENT OF YCF.

FOLLOW US!

YouTube f t i

€ www.ycf-riding.de

