

Swizz-Light

Auszug aus unserem Kernsortiment

Stand: 04/ 2023



...we light you up

Schienenstrahler, Aufbauleuchten, Strahler für Rasterdeckenhaken



Nova XS
Seite 4



Nova XSE
Seite 5



Nova XSW
Seite 6



Nova XSR
Seite 7



Nova XS R2
Seite 8



Nova
Seite 9



Nova E
Seite 10



Nova W
Seite 11



Pina XS
Seite 12



Pina XSG
Seite 13



Pina XL
Seite 14



Pina XLG
Seite 15



Pina XLG 2
Seite 16



Tube
Seite 17



Linea
Seite 18

Einbauleuchten



Kim XS
Seite 19



Kim
Seite 20



Caya
Seite 21



Move XS
Seite 22



Move XL
Seite 23



Boxx
Seite 24



Tec
Seite 25



Pavo XS
Seite 26



Pavo XL
Seite 27

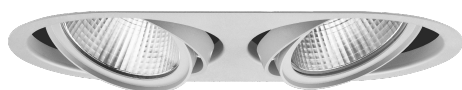

Pavo 2
Seite 28



Pavo 3
Seite 29



Wall
Seite 30



Doro XS1
Seite 31



Doro XS2
Seite 32



Doro XS3
Seite 33



Doro 1
Seite 34

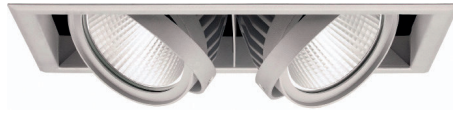

Doro 2
Seite 35



Doro 3
Seite 36



Down 174
Seite 37



Down 230
Seite 38



Down 260
Seite 39

Aufbauleuchten



Doro A 150
Seite 40



Doro A 237
Seite 41

Pendelleuchten



Doro P 150
Seite 42



Doro P 237
Seite 43



Factory
Seite 44



Sina P2
Seite 45



Sina P3
Seite 46



Sina P4
Seite 47



Round
Seite 48

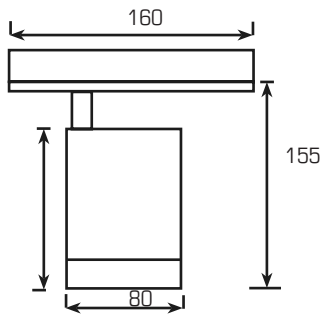



Nova XS

- LED Stromschienen-Strahler 350° drehbar und 90° schwenkbar
 - Philips Fortimo LED SLM - Beste Lichtqualität für alle Anwendungen
 - Inkl. Stromschienen-Adapter-Treiber
 - Strahler-Material: Aluminium
 - Pulverbeschichtet
 - Reflektoren aus 99,9 % Reinstaluminium
 - Schutzglas schützt Chip und Reflektor vor Verunreinigungen
 - Bajonettfrontring für werkzeuglosen Reflektorwechsel
 - Passive Kühlung
 - Auf Anfrage: Andere RAL-Farben, DALI, CASAMBI, Farbfilter, Wabenraster
- LED Spotlight 350° turnable and 90° adjustable
 - Philips Fortimo LED SLM - Best quality of light available for all applications
 - Incl. Track adaptor driver
 - Spotlight-material: aluminium
 - Powder coated
 - Reflectors made of pure aluminium 99,9 %
 - Clear glass protects chip and reflector against dust and dirt
 - Twist and lock frontring for change reflectors without any tools
 - Passive cooling
 - Upon demand: Other RAL-color, DALI, CASAMBI, color filter, honeycomb

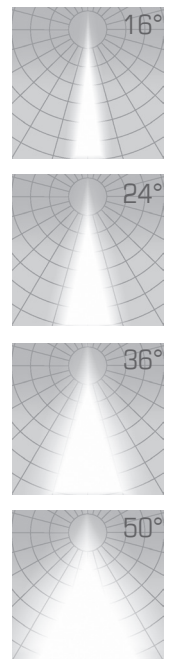
Ausstrahlwinkel
beam angle



Standard RAL

-  9006 silber / silver
-  9005 schwarz / black
-  9016 weiß / white

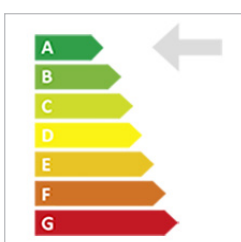

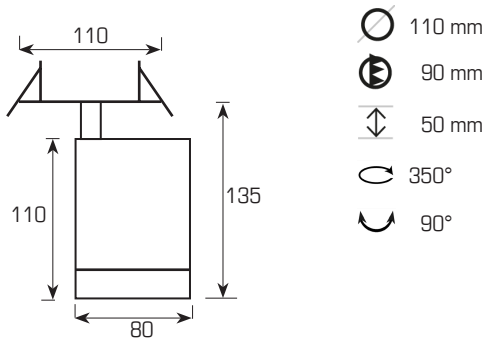



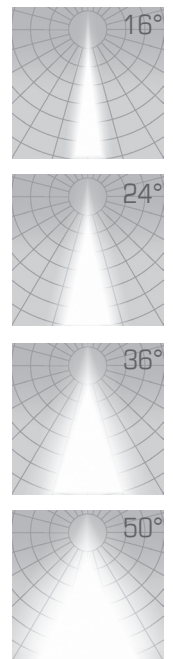

Nova XSE

- LED Einbauleuchte 350° drehbar und 90° schwenkbar
 - Philips Fortimo LED SLM - Beste Lichtqualität für alle Anwendungen
 - Inkl. Treiber
 - Leuchten-Material: Aluminium
 - Pulverbeschichtet
 - Reflektoren aus 99,9 % Reinstaluminium
 - Schutzglas schützt Chip und Reflektor vor Verunreinigungen
 - Bajonettfrontring für werkzeuglosen Reflektorwechsel
 - Passive Kühlung
 - Auf Anfrage: Andere RAL-Farben, DALI, CASAMBI, Farbfilter, Wabenraster, Ausgleichsrahmen
- LED recessed luminaire 350° turnable and 90° adjustable
 - Philips Fortimo LED SLM - Best quality of light available for all applications
 - Incl. driver
 - Luminaire-material: aluminium
 - Powder coated
 - Reflectors made of pure aluminium 99,9 %
 - Clear glass protects chip and reflector against dust and dirt
 - Twist and lock frontring for change reflectors without any tools
 - Passive cooling
 - Upon demand: Other RAL-color, DALI, CASAMBI color filter, honeycomb, Downlight-Adapter

Ausstrahlwinkel
beam angle



Standard RAL	
	9006 silber / silver
	9005 schwarz / black
	9016 weiß / white

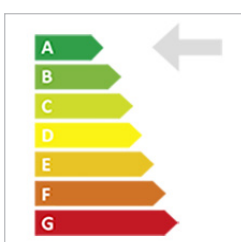

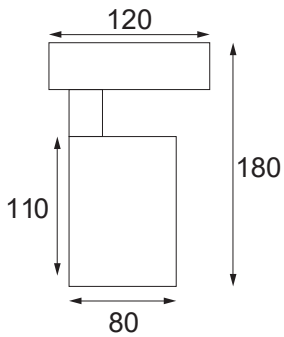

Made in Germany



Nova XSW

- LED Aufbau-Strahler 350° drehbar und 90° schwenkbar
 - Philips Fortimo LED SLM - Beste Lichtqualität für alle Anwendungen
 - Deckenanbaudose inkl. Treiber
 - Strahler-Material: Aluminium
 - Pulverbeschichtet
 - Reflektoren aus 99,9 % Reinstaluminium
 - Schutzglas schützt Chip und Reflektor vor Verunreinigungen
 - Bajonettfrontring für werkzeuglosen Reflektorwechsel
 - Passive Kühlung
 - Auf Anfrage: Andere RAL-Farben, DALI, CASAMBI, Farbfilter, Wabenraster
- LED Spotlight 350° turnable and 90° adjustable
 - Philips Fortimo LED SLM - Best quality of light available for all applications
 - Incl. surface mounting set
 - Spotlight-material: aluminium
 - Powder coated
 - Reflectors made of pure aluminium 99,9 %
 - Clear glass protects chip and reflector against dust and dirt
 - Twist and lock frontring for change reflectors without any tools
 - Passive cooling
 - Upon demand: Other RAL-color, DALI, CASAMBI, color filter, honeycomb

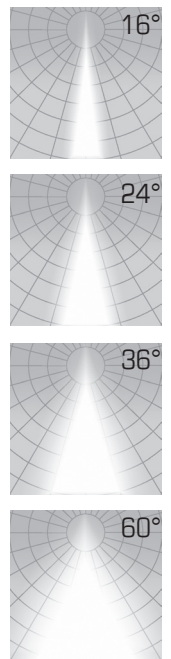
Ausstrahlwinkel / beam angle



Standard RAL

-  9006 silber / silver
-  9005 schwarz / black
-  9016 weiß / white



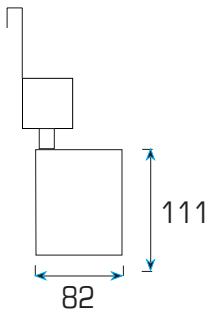



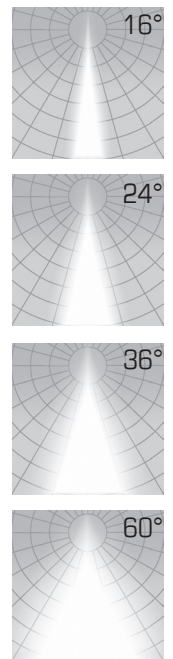

Nova XSR

- LED Einbauleuchte 350° drehbar und 90° schwenkbar
 - Philips Fortimo LED SLM - Beste Lichtqualität für alle Anwendungen
 - Inkl. Treiber
 - Leuchten-Material: Aluminium
 - Pulverbeschichtet
 - Reflektoren aus 99,9 % Reinstaluminium
 - Schutzglas schützt Chip und Reflektor vor Verunreinigungen
 - Bajonettfrontring für werkzeuglosen Reflektorwechsel
 - Passive Kühlung
 - Auf Anfrage: Andere RAL-Farben, DALI, CASAMBI, Farbfilter, Wabenraster
-
- LED recessed luminaire 350° turnable and 90° adjustable
 - Philips Fortimo LED SLM - Best quality of light available for all applications
 - Incl. driver
 - Luminaire-material: aluminium
 - Powder coated
 - Reflectors made of pure aluminium 99,9 %
 - Clear glass protects chip and reflector against dust and dirt
 - Twist and lock frontring for change reflectors without any tools
 - Passive cooling
 - Upon demand: Other RAL-color, DALI, CASAMBI color filter, honeycomb

Ausstrahlwinkel
beam angle



Standard RAL	
	9006 silber / silver
	9005 schwarz / black
	9016 weiß / white



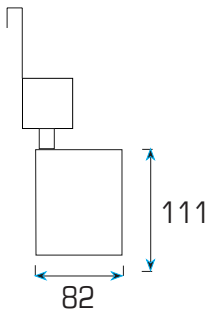



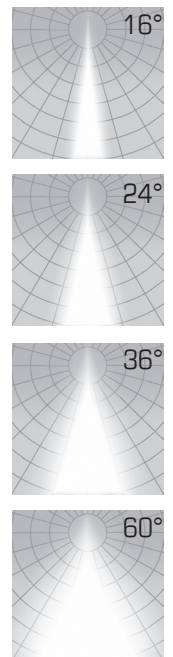

Nova XS R2

- LED Einbauleuchte 350° drehbar und 90° schwenkbar
 - Philips Fortimo LED SLM - Beste Lichtqualität für alle Anwendungen
 - Inkl. Treiber
 - Leuchten-Material: Aluminium
 - Pulverbeschichtet
 - Reflektoren aus 99,9 % Reinstaluminium
 - Schutzglas schützt Chip und Reflektor vor Verunreinigungen
 - Bajonettfrontring für werkzeuglosen Reflektorwechsel
 - Passive Kühlung
 - Auf Anfrage: Andere RAL-Farben, DALI, CASAMBI, Farbfilter, Wabenraster
-
- LED recessed luminaire 350° turnable and 90° adjustable
 - Philips Fortimo LED SLM - Best quality of light available for all applications
 - Incl. driver
 - Luminaire-material: aluminium
 - Powder coated
 - Reflectors made of pure aluminium 99,9 %
 - Clear glass protects chip and reflector against dust and dirt
 - Twist and lock frontring for change reflectors without any tools
 - Passive cooling
 - Upon demand: Other RAL-color, DALI, CASAMBI color filter, honeycomb

Ausstrahlwinkel
beam angle



Standard RAL

	9006 silber / silver
	9005 schwarz / black
	9016 weiß / white

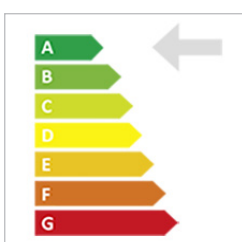

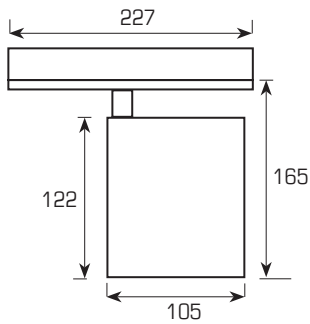



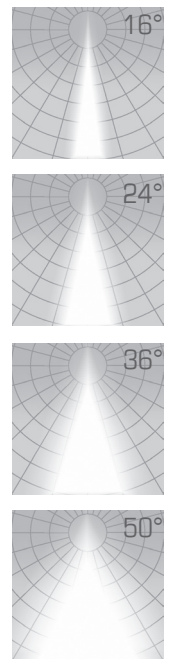

Nova

- LED Stromschienen-Strahler 350° drehbar und 90° schwenkbar
 - Philips Fortimo LED SLM - Beste Lichtqualität für alle Anwendungen
 - Inkl. Stromschienen-Adapter-Treiber
 - Strahler-Material: Aluminium
 - Pulverbeschichtet
 - Reflektoren aus 99,9 % Reinstaluminium
 - Schutzglas schützt Chip und Reflektor vor Verunreinigungen
 - Bajonettfrontring für werkzeuglosen Reflektorwechsel
 - Passive Kühlung
 - Auf Anfrage: Andere RAL-Farben, DALI, CASAMBI, Farbfilter, Wabenraster
- LED Spotlight 350° turnable and 90° adjustable
 - Philips Fortimo LED SLM - Best quality of light available for all applications
 - Incl. Track adaptor driver
 - Spotlight-material: aluminium
 - Powder coated
 - Reflectors made of pure aluminium 99,9 %
 - Clear glass protects chip and reflector against dust and dirt
 - Twist and lock frontring for change reflectors without any tools
 - Passive cooling
 - Upon demand: Other RAL-color, DALI, CASAMBI, color filter, honeycomb





Ausstrahlwinkel
beam angle

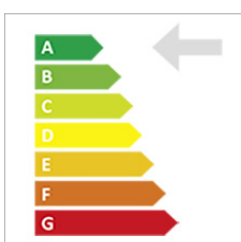

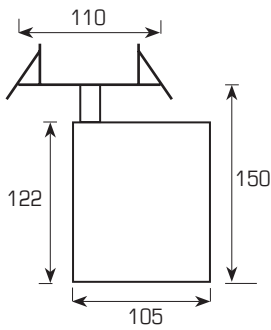
- Standard RAL
-  9006 silber / silver
 -  9005 schwarz / black
 -  9016 weiß / white





-  110 mm
-  90 mm
-  150 mm
-  350°
-  90°





 220-240V
50-60Hz
1.10 kg









 Made in Germany





Nova E

- LED Einbauleuchte 350° drehbar und 90° schwenkbar
 - Philips Fortimo LED SLM - Beste Lichtqualität für alle Anwendungen
 - Inkl. Treiber
 - Leuchten-Material: Aluminium
 - Pulverbeschichtet
 - Reflektoren aus 99,9 % Reinstaluminium
 - Schutzglas schützt Chip und Reflektor vor Verunreinigungen
 - Bajonettfrontring für werkzeuglosen Reflektorwechsel
 - Passive Kühlung
 - Auf Anfrage: Andere RAL-Farben, DALI, CASAMBI, Farbfilter, Wabenraster, Ausgleichsrahmen
- LED recessed luminaire 350° turnable and 90° adjustable
 - Philips Fortimo LED SLM - Best quality of light available for all applications
 - Incl. driver
 - Luminaire-material: aluminium
 - Powder coated
 - Reflectors made of pure aluminium 99,9 %
 - Clear glass protects chip and reflector against dust and dirt
 - Twist and lock frontring for change reflectors without any tools
 - Passive cooling
 - Upon demand: Other RAL-color, DALI, CASAMBI, color filter, honeycomb, Downlight-Adapter

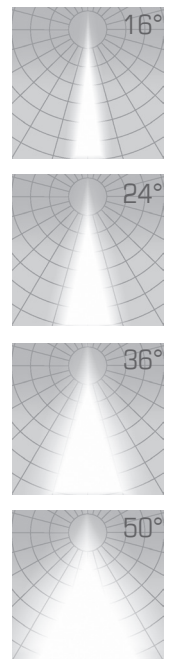
Ausstrahlwinkel
beam angle



- Standard RAL
-  9006 silber / silver
 -  9005 schwarz / black
 -  9016 weiß / white



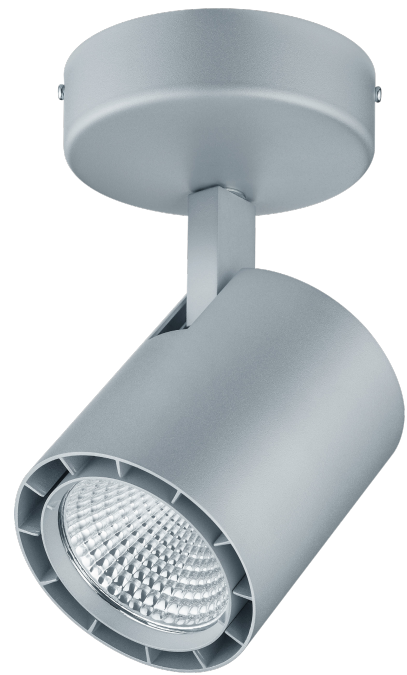
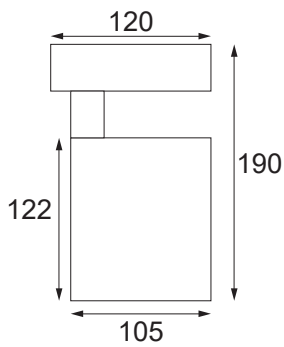



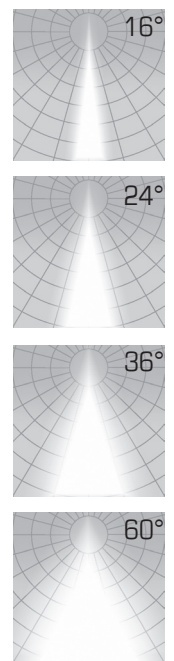

Nova W

- LED Aufbau-Strahler 350° drehbar und 90° schwenkbar
 - Philips Fortimo LED SLM - Beste Lichtqualität für alle Anwendungen
 - Deckenanbaudose inkl. Treiber
 - Strahler-Material: Aluminium
 - Pulverbeschichtet
 - Reflektoren aus 99,9 % Reinstaluminium
 - Schutzglas schützt Chip und Reflektor vor Verunreinigungen
 - Bajonettfrontring für werkzeuglosen Reflektorwechsel
 - Passive Kühlung
 - Auf Anfrage: Andere RAL-Farben, DALI, CASAMBI, Farbfilter, Wabenraster
- LED Spotlight 350° turnable and 90° adjustable
 - Philips Fortimo LED SLM - Best quality of light available for all applications
 - Incl. surface mounting set
 - Spotlight-material: aluminium
 - Powder coated
 - Reflectors made of pure aluminium 99,9 %
 - Clear glass protects chip and reflector against dust and dirt
 - Twist and lock frontring for change reflectors without any tools
 - Passive cooling
 - Upon demand: Other RAL-color, DALI, CASAMBI, color filter, honeycomb

Ausstrahlwinkel / beam angle



Standard RAL

	9006 silber / silver
	9005 schwarz / black
	9016 weiß / white

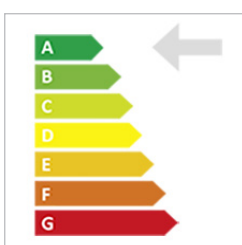

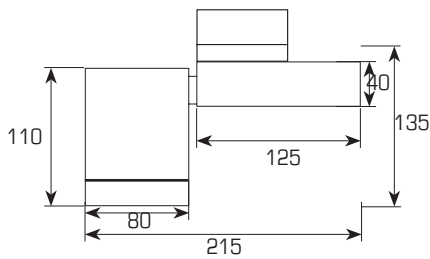

 350°
 2 x 90°



 Made in Germany





Pina XS

- LED Strahlschienen-Strahler 350° drehbar und 180° schwenkbar
 - Philips Fortimo LED SLM - Beste Lichtqualität für alle Anwendungen
 - 3-Phasen-Universaladapter
 - Strahler-Material: Aluminium
 - Pulverbeschichtet
 - Reflektoren aus 99,9 % Reinstaluminium
 - Schutzglas schützt Chip und Reflektor vor Verunreinigungen
 - Bajonettfrontring für werkzeuglosen Reflektorwechsel
 - Passive Kühlung
 - Auf Anfrage: Andere RAL-Farben, DALI, CASAMBI, Farbfilter, Wabenraster
- LED Spotlight 350° turnable and 180° adjustable
 - Philips Fortimo LED SLM - Best quality of light available for all applications
 - 3-phase-uniadapter
 - Spotlight-material: aluminium
 - Powder coated
 - Reflectors made of pure aluminium 99,9 %
 - Clear glass protects chip and reflector against dust and dirt
 - Twist and lock frontring for change reflectors without any tools
 - Passive cooling
 - Upon demand: Other RAL-color, DALI, CASAMBI, color filter, honeycomb

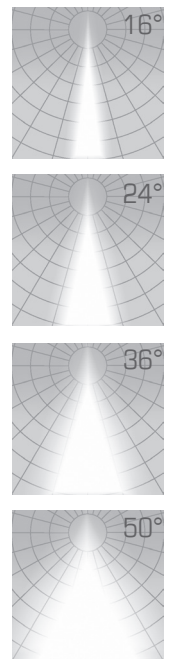
Ausstrahlwinkel
beam angle



Standard RAL

-  9006 silber / silver
-  9005 schwarz / black
-  9016 weiß / white

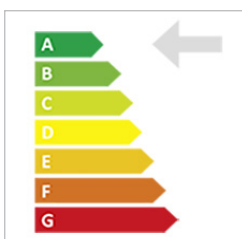

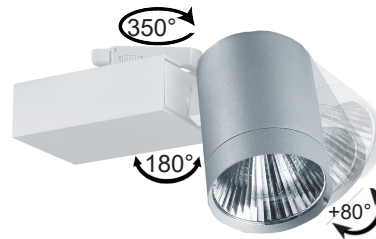
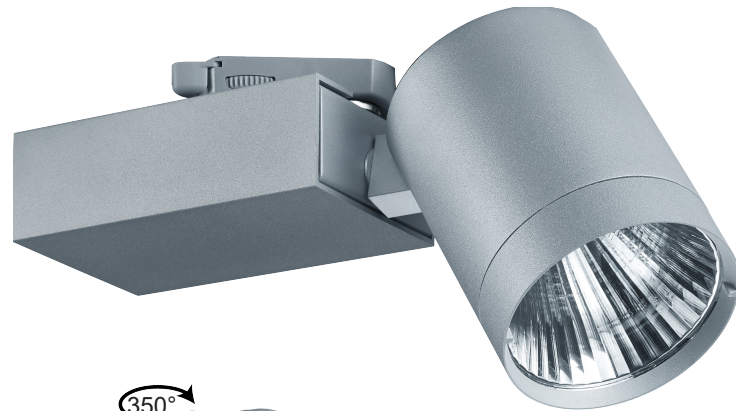
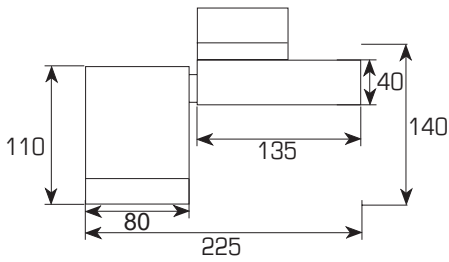



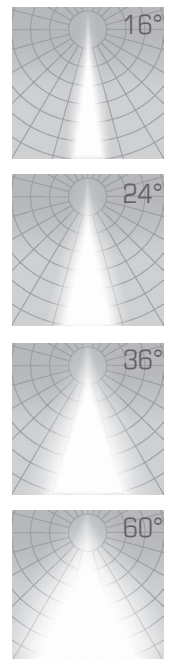

Pina XSG

- LED Strahlschienen-Strahler 350° drehbar und 180° schwenkbar
 - Philips Fortimo LED SLM - Beste Lichtqualität für alle Anwendungen
 - 3-Phasen-Universaladapter
 - Strahler-Material: Aluminium
 - Pulverbeschichtet
 - Reflektoren aus 99,9 % Reinaluminium
 - Schutzglas schützt Chip und Reflektor vor Verunreinigungen
 - Bajonettfrontring für werkzeuglosen Reflektorwechsel
 - Passive Kühlung
 - Auf Anfrage: Andere RAL-Farben, DALI, CASAMBI, Farbfilter, Wabenraster
- LED Spotlight 350° turnable and 180° adjustable
 - Philips Fortimo LED SLM - Best quality of light available for all applications
 - 3-phase-uniadapter
 - Spotlight-material: aluminium
 - Powder coated
 - Reflectors made of pure aluminium 99,9 %
 - Clear glass protects chip and reflector against dust and dirt
 - Twist and lock frontring for change reflectors without any tools
 - Passive cooling
 - Upon demand: Other RAL-color, DALI, CASAMBI, color filter, honeycomb

Ausstrahlwinkel
beam angle



Standard RAL

	9006 silber / silver
	9005 schwarz / black
	9016 weiß / white



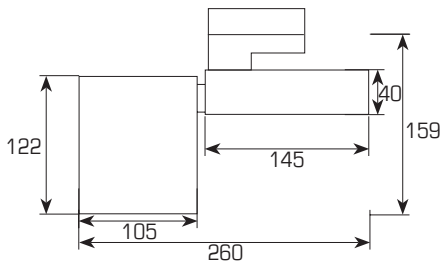

Made in Germany



Pina XL

- LED Strahlschienen-Strahler 350° drehbar und 180° schwenkbar
 - Philips Fortimo LED SLM - Beste Lichtqualität für alle Anwendungen
 - 3-Phasen-Universaladapter
 - Strahler-Material: Aluminium
 - Pulverbeschichtet
 - Reflektoren aus 99,9 % Reinstaluminium
 - Schutzglas schützt Chip und Reflektor vor Verunreinigungen
 - Bajonettfrontring für werkzeuglosen Reflektorwechsel
 - Passive Kühlung
 - Auf Anfrage: Andere RAL-Farben, DALI, CASAMBI, Farbfilter, Wabenraster
- LED Spotlight 350° turnable and 180° adjustable
 - Philips Fortimo LED SLM - Best quality of light available for all applications
 - 3-phase-uniadapter
 - Spotlight-material: aluminium
 - Powder coated
 - Reflectors made of pure aluminium 99,9 %
 - Clear glass protects chip and reflector against dust and dirt
 - Twist and lock frontring for change reflectors without any tools
 - Passive cooling
 - Upon demand: Other RAL-color, DALI, CASAMBI, color filter, honeycomb

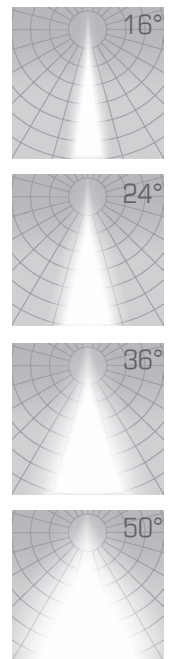
Ausstrahlwinkel
beam angle



Standard RAL

-  9006 silber / silver
-  9005 schwarz / black
-  9016 weiß / white



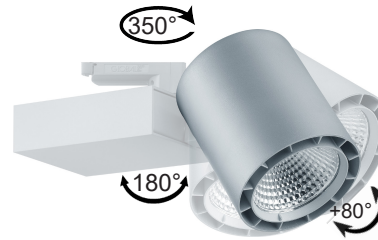
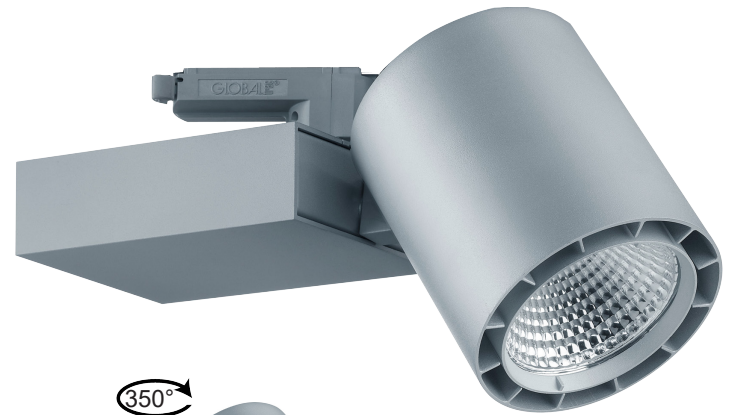
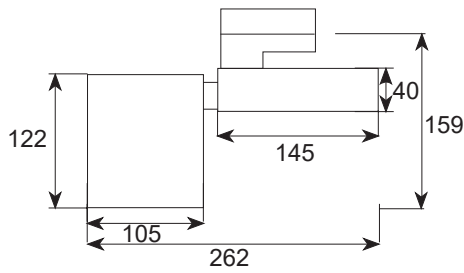



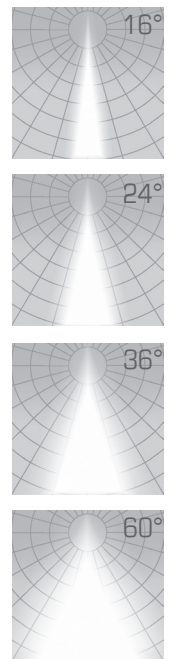

Pina XLG

- LED Strahlschienen-Strahler 350° drehbar und 180° schwenkbar
 - Philips Fortimo LED SLM - Beste Lichtqualität für alle Anwendungen
 - 3-Phasen-Universaladapter
 - Strahler-Material: Aluminium
 - Pulverbeschichtet
 - Reflektoren aus 99,9 % Reinstaluminium
 - Schutzglas schützt Chip und Reflektor vor Verunreinigungen
 - Bajonettfrontring für werkzeuglosen Reflektorwechsel
 - Passive Kühlung
 - Auf Anfrage: Andere RAL-Farben, DALI, CASAMBI, Farbfilter, Wabenraster
- LED Spotlight 350° turnable and 180° adjustable
 - Philips Fortimo LED SLM - Best quality of light available for all applications
 - 3-phase-uniadapter
 - Spotlight-material: aluminium
 - Powder coated
 - Reflectors made of pure aluminium 99,9 %
 - Clear glass protects chip and reflector against dust and dirt
 - Twist and lock frontring for change reflectors without any tools
 - Passive cooling
 - Upon demand: Other RAL-color, DALI, CASAMBI, color filter, honeycomb

Ausstrahlwinkel
beam angle



Standard RAL

-  9006 silber / silver
-  9005 schwarz / black
-  9016 weiß / white



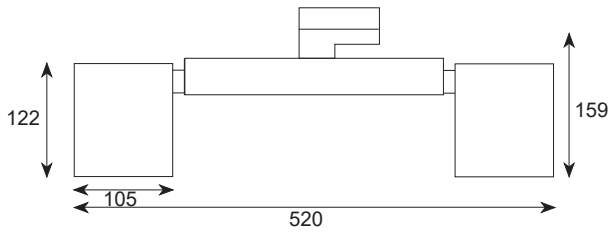

 Made in Germany





Pina XLG 2

- LED Strahlschienen-Strahler 350° drehbar und 180° schwenkbar
 - Philips Fortimo LED SLM - Beste Lichtqualität für alle Anwendungen
 - 3-Phasen-Universaladapter
 - Strahler-Material: Aluminium
 - Pulverbeschichtet
 - Reflektoren aus 99,9 % Reinstaluminium
 - Schutzglas schützt Chip und Reflektor vor Verunreinigungen
 - Bajonettfrontring für werkzeuglosen Reflektorwechsel
 - Passive Kühlung
 - Auf Anfrage: Andere RAL-Farben, DALI, CASAMBI, Farbfilter, Wabenraster
- LED Spotlight 350° turnable and 180° adjustable
 - Philips Fortimo LED SLM - Best quality of light available for all applications
 - 3-phase-uniadapter
 - Spotlight-material: aluminium
 - Powder coated
 - Reflectors made of pure aluminium 99,9 %
 - Clear glass protects chip and reflector against dust and dirt
 - Twist and lock frontring for change reflectors without any tools
 - Passive cooling
 - Upon demand: Other RAL-color, DALI, CASAMBI, color filter, honeycomb

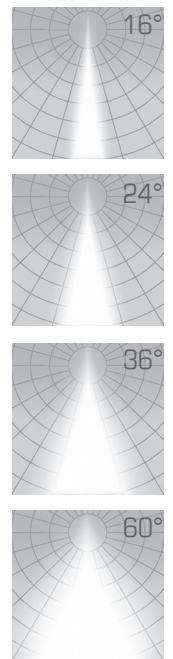
Ausstrahlwinkel
beam angle



Standard RAL

-  9006 silber / silver
-  9005 schwarz / black
-  9016 weiß / white



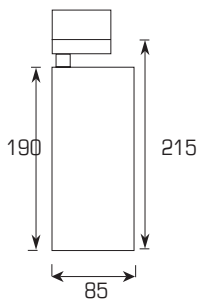



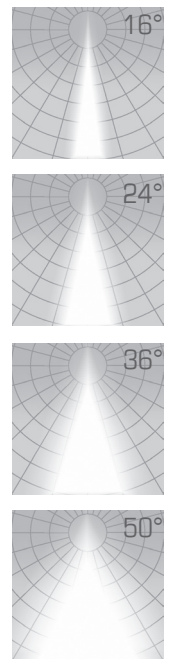

Tube

- LED Strahlschienen-Strahler 350° drehbar und 90° schwenkbar
 - Philips Fortimo LED SLM - Beste Lichtqualität für alle Anwendungen
 - 3-Phasen-Universaladapter
 - Strahler-Material: Aluminium
 - Pulverbeschichtet
 - Reflektoren aus 99,9 % Reinstaluminium
 - Schutzglas schützt Chip und Reflektor vor Verunreinigungen
 - Bajonettfrontring für werkzeuglosen Reflektorwechsel
 - Passive Kühlung
 - Auf Anfrage: Andere RAL-Farben, DALI, CASAMBI, Farbfilter, Wabenraster
- LED Spotlight 350° turnable and 90° adjustable
 - Philips Fortimo LED SLM - Best quality of light available for all applications
 - 3-phase-uniadapter
 - Spotlight-material: aluminium
 - Powder coated
 - Reflectors made of pure aluminium 99,9 %
 - Clear glass protects chip and reflector against dust and dirt
 - Twist and lock frontring for change reflectors without any tools
 - Passive cooling
 - Upon demand: Other RAL-color, DALI, CASAMBI, color filter, honeycomb

Ausstrahlwinkel
beam angle



Standard RAL

	9006 silber / silver
	9005 schwarz / black
	9016 weiß / white



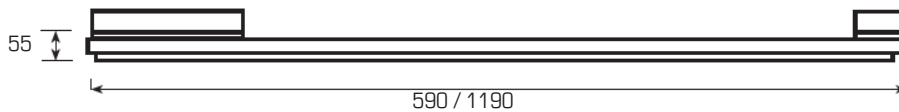

 Made in Germany

Linea



- LED Module in drei verschiedenen Längen 590 mm und 1190 mm
- direkte Stromschienenmontage mit Adaptertreibern
- Standardlichtfarben 3000 K und 4000 K
- 5 verschiedene Optiken für spezielle Lichtverteilungscharakteristiken
- Schnelle und einfache Montage auch in sehr engen Leuchtenanwendungen (Lichtkanal)
- Akustisches und fühlbares Feedback bei der Lampenmontage „Click-Fit“
- Formschönes Design, klare Formsprache, hochwertige Anmutung
- Enge Farbtoleranz: McAdams 3,5 SDCM
- Lebensdauer L70 > 50.000 h
- Umgebungstemperatur: - 30 °C bis + 45 °C

- LED moduls three different lengths 590 mm and 1190 mm
- Direct track mounting with adapter-drivers
- Standard lightcolours 3000 K und 4000 K
- 5 different optics for special light distribution characteristics
- Quick and easy installation even in very narrow luminaires (slot light channels)
- Audible and tactile feedback during mounting process „Click-Fit“
- Straight and pure design, genuine high grade materials
- Tight colour tolerance: McAdams 3.5 SDCM
- Life span L70 > 50.000 h
- Ambient temperature: - 30 °C bis + 45 °C

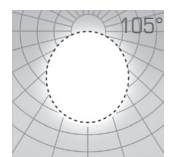
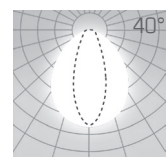
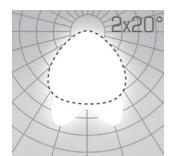
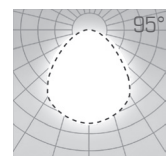
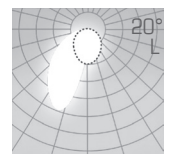
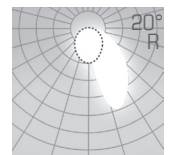
Ausstrahlwinkel
beam angle



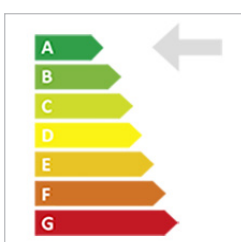

Farben / color

-  alu-grau / alu-grey
-  alu-weiss / alu-white

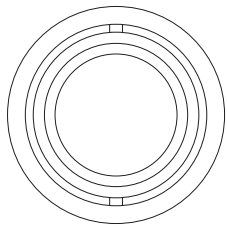



-  150 mm
-  140 mm
-  160 mm
-  2 x 40°



 Made in Germany





Kim XS

- LED Einbauleuchte kardanisch 2 x 40° schwenkbar
 - Philips Fortimo LED SLM - Beste Lichtqualität für alle Anwendungen
 - Inkl. Treiber
 - Leuchten-Material: Aluminium
 - Pulverbeschichtet
 - Reflektoren aus 99,9 % Reinstaluminium
 - Schutzglas schützt Chip und Reflektor vor Verunreinigungen
 - Bajonettfrontring für werkzeuglosen Reflektorwechsel
 - Passive Kühlung
 - Auf Anfrage: Andere RAL-Farben, DALI, CASAMBI, Farbfilter, Wabenraster, Ausgleichsrahmen
-
- LED recessed luminaire gimbaled 2 x 40° adjustable
 - Philips Fortimo LED SLM - Best quality of light available for all applications
 - Incl. driver
 - Luminaire-material: aluminium
 - Powder coated
 - Reflectors made of pure aluminium 99,9 %
 - Clear glass protects chip and reflector against dust and dirt
 - Twist and lock frontring for change reflectors without any tools
 - Passive cooling
 - Upon demand: Other RAL-color, DALI, CASAMBI, color filter, honeycomb, Downlight-Adapter

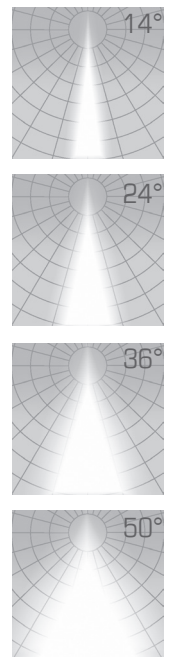
Ausstrahlwinkel
beam angle



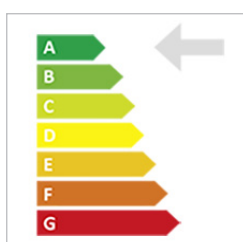

Standard RAL

-  9006 silber / silver
-  9005 schwarz / black
-  9016 weiß / white

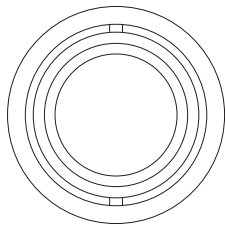



-  170 mm
-  140 mm
-  160 mm
-  2 x 40°



 Made in Germany



Kim



- LED Einbauleuchte kardanisich 2 x 40° schwenkbar
- Philips Fortimo LED SLM - Beste Lichtqualität für alle Anwendungen
- Inkl. Treiber
- Leuchten-Material: Aluminium
- Pulverbeschichtet
- Reflektoren aus 99,9 % Reinstaluminium
- Schutzglas schützt Chip und Reflektor vor Verunreinigungen
- Bajonettfrontring für werkzeuglosen Reflektorwechsel
- Passive Kühlung
- Auf Anfrage: Andere RAL-Farben, DALI, CASAMBI, Farbfilter, Wabenraster, Ausgleichsrahmen
- **Variabler Außendurchmesser. Ideal für Sanierungen!**

- LED recessed luminaire gimballled 2 x 40° adjustable
- Philips Fortimo LED SLM - Best quality of light available for all applications
- Incl. driver
- Luminaire-material: aluminium
- Powder coated
- Reflectors made of pure aluminium 99,9 %
- Clear glass protects chip and reflector against dust and dirt
- Twist and lock frontring for change reflectors without any tools
- Passive cooling
- Upon demand: Other RAL-color, DALI, CASAMBI, color filter, honeycomb, Downlight-Adapter
- **Variable outer diameter. Ideal for renovation!**

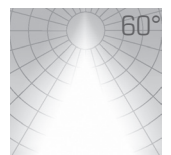
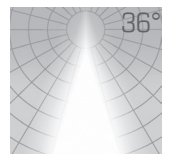
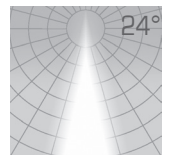
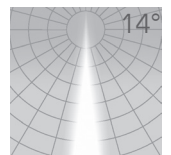
Austrahlwinkel
beam angle





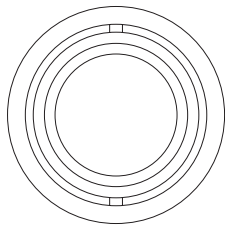

Standard RAL

-  9006 silber / silver
-  9005 schwarz / black
-  9016 weiß / white





-  125 mm
-  117 mm
-  125 mm
-  2 x 40°

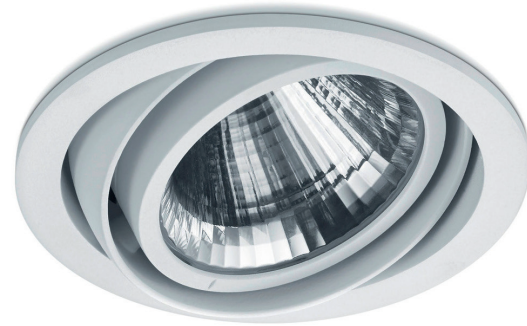

 Made in Germany





Caya

- LED Einbauleuchte 2 x 40° schwenkbar
 - Philips Fortimo LED SLM - Beste Lichtqualität für alle Anwendungen
 - Inkl. Treiber
 - Leuchten-Material: Aluminium
 - Pulverbeschichtet
 - Reflektoren aus 99,9 % Reinstaluminium
 - Schutzglas schützt Chip und Reflektor vor Verunreinigungen
 - Bajonettfrontring für werkzeuglosen Reflektorwechsel
 - Passive Kühlung
 - Auf Anfrage: Andere RAL-Farben, DALI, CASAMBI, Farbfilter, Wabenraster, Ausgleichsrahmen
-
- LED recessed luminaire 2 x 40° adjustable
 - Philips Fortimo LED SLM - Best quality of light available for all applications
 - Incl. driver
 - Luminaire-material: aluminium
 - Powder coated
 - Reflectors made of pure aluminium 99,9 %
 - Clear glass protects chip and reflector against dust and dirt
 - Twist and lock frontring for change reflectors without any tools
 - Passive cooling
 - Upon demand: Other RAL-color, DALI, CASAMBI, color filter, honeycomb, Downlight-Adapter

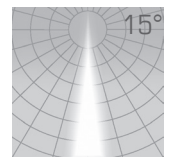
Ausstrahlwinkel
beam angle



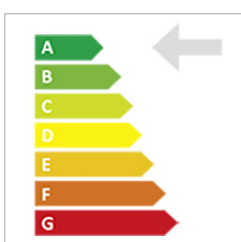

Standard RAL

-  9006 silber / silver
-  9005 schwarz / black
-  9016 weiß / white

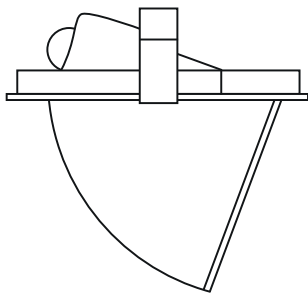



-  158 mm
-  145 mm
-  120 mm
-  350°
-  55°



 Made in Germany





Move XS

- LED Einbauleuchte 350° drehbar und 55° ausschwenkbar
 - Philips Fortimo LED SLM - Beste Lichtqualität für alle Anwendungen
 - Inkl. Treiber
 - Leuchten-Material: Aluminium
 - Pulverbeschichtet
 - Reflektoren aus 99,9 % Reinstaluminium
 - Schutzglas schützt Chip und Reflektor vor Verunreinigungen
 - Bajonettfrontring für werkzeuglosen Reflektorwechsel
 - Passive Kühlung
 - Auf Anfrage: Andere RAL-Farben, DALI, CASAMBI, Farbfilter, Wabenraster, Ausgleichsrahmen
-
- LED recessed luminaire 350° turnable and 55° adjustable
 - Philips Fortimo LED SLM - Best quality of light available for all applications
 - Incl. driver
 - Luminaire-material: aluminium
 - Powder coated
 - Reflectors made of pure aluminium 99,9 %
 - Clear glass protects chip and reflector against dust and dirt
 - Twist and lock frontring for change reflectors without any tools
 - Passive cooling
 - Upon demand: Other RAL-color, DALI, CASAMBI, color filter, honeycomb, Downlight-Adapter

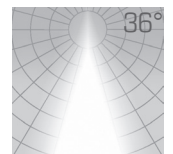
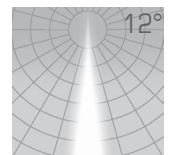
Ausstrahlwinkel
beam angle





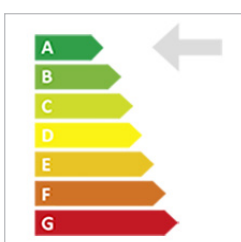

Standard RAL

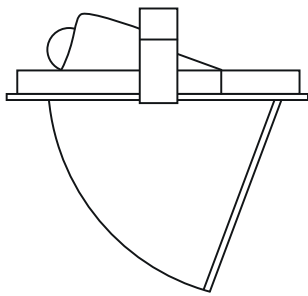
-  9006 silber / silver
-  9005 schwarz / black
-  9016 weiß / white





-  193 mm
-  180 mm
-  150 mm
-  350°
-  55°



 Made in Germany





Move XL

- LED Einbauleuchte 350° drehbar und 55° ausschwenkbar
 - Philips Fortimo LED SLM - Beste Lichtqualität für alle Anwendungen
 - Inkl. Treiber
 - Leuchten-Material: Aluminium
 - Pulverbeschichtet
 - Reflektoren aus 99,9 % Reinstaluminium
 - Schutzglas schützt Chip und Reflektor vor Verunreinigungen
 - Bajonettfrontring für werkzeuglosen Reflektorwechsel
 - Passive Kühlung
 - Auf Anfrage: Andere RAL-Farben, DALI, CASAMBI, Farbfilter, Wabenraster, Ausgleichsrahmen
-
- LED recessed luminaire 350° turnable and 55° adjustable
 - Philips Fortimo LED SLM - Best quality of light available for all applications
 - Incl. driver
 - Luminaire-material: aluminium
 - Powder coated
 - Reflectors made of pure aluminium 99,9 %
 - Clear glass protects chip and reflector against dust and dirt
 - Twist and lock frontring for change reflectors without any tools
 - Passive cooling
 - Upon demand: Other RAL-color, DALI, CASAMBI, color filter, honeycomb, Downlight-Adapter

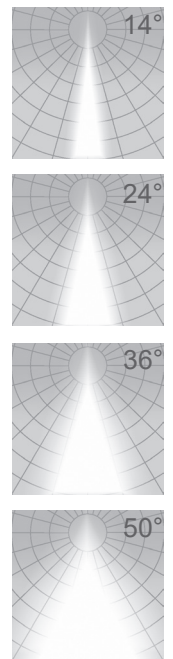
Austrahlwinkel
beam angle



- Standard RAL
-  9006 silber / silver
 -  9005 schwarz / black
 -  9016 weiß / white

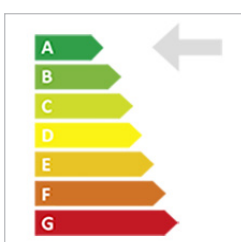

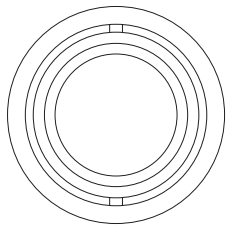

-  158 mm
-  145 mm
-  120 mm
-  2 x 25°
-  350°



 Made in Germany





Boxx

- LED Einbauleuchte 2 x 40° schwenkbar
 - Philips Fortimo LED SLM - Beste Lichtqualität für alle Anwendungen
 - Inkl. Treiber
 - Leuchten-Material: Aluminium
 - Pulverbeschichtet
 - Reflektoren aus 99,9 % Reinstaluminium
 - Schutzglas schützt Chip und Reflektor vor Verunreinigungen
 - Bajonettfrontring für werkzeuglosen Reflektorwechsel
 - Passive Kühlung
 - Auf Anfrage: Andere RAL-Farben, DALI, CASAMBI, Farbfilter, Wabenraster, Ausgleichsrahmen
-
- LED recessed luminaire 2 x 40° adjustable
 - Philips Fortimo LED SLM - Best quality of light available for all applications
 - Incl. driver
 - Luminaire-material: aluminium
 - Powder coated
 - Reflectors made of pure aluminium 99,9 %
 - Clear glass protects chip and reflector against dust and dirt
 - Twist and lock frontring for change reflectors without any tools
 - Passive cooling
 - Upon demand: Other RAL-color, DALI, CASAMBI, color filter, honeycomb, Downlight-Adapter

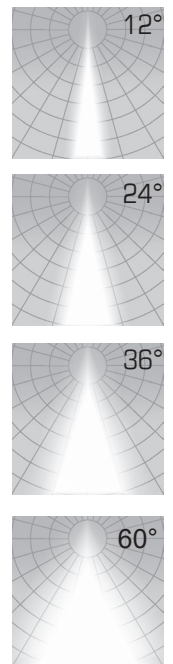
Ausstrahlwinkel / beam angle



- Standard RAL
-  9006 silber / silver
 -  9005 schwarz / black
 -  9016 weiß / white

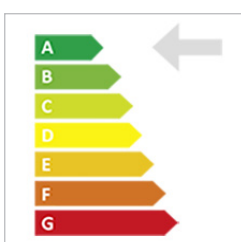

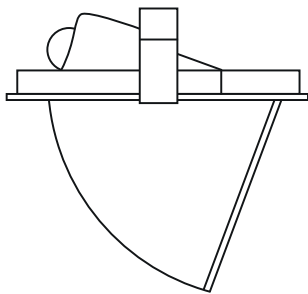

-  130 mm
-  120 mm
-  115 mm
-  350°
-  45°



 Made in Germany





Tec

- LED Einbauleuchte 350° drehbar und 45° ausschwenkbar
 - Philips Fortimo LED SLM - Beste Lichtqualität für alle Anwendungen
 - Inkl. Treiber
 - Leuchten-Material: Aluminium
 - Pulverbeschichtet
 - Reflektoren aus 99,9 % Reinstaluminium
 - Schutzglas schützt Chip und Reflektor vor Verunreinigungen
 - Bajonettfrontring für werkzeuglosen Reflektorwechsel
 - Passive Kühlung
 - Auf Anfrage: Andere RAL-Farben, DALI, CASAMBI, Farbfilter, Wabenraster, Ausgleichsrahmen
-
- LED recessed luminaire 350° turnable and 45° adjustable
 - Philips Fortimo LED SLM - Best quality of light available for all applications
 - Incl. driver
 - Luminaire-material: aluminium
 - Powder coated
 - Reflectors made of pure aluminium 99,9 %
 - Clear glass protects chip and reflector against dust and dirt
 - Twist and lock frontring for change reflectors without any tools
 - Passive cooling
 - Upon demand: Other RAL-color, DALI, CASAMBI, color filter, honeycomb, Downlight-Adapter

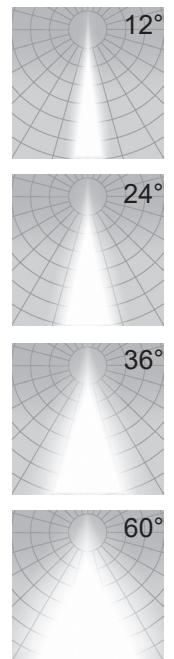



Ausstrahlwinkel
beam angle



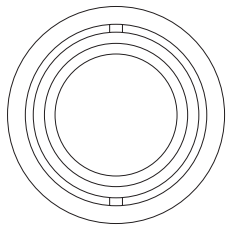

- Standard RAL
-  9006 silber / silver
 -  9005 schwarz / black
 -  9016 weiß / white



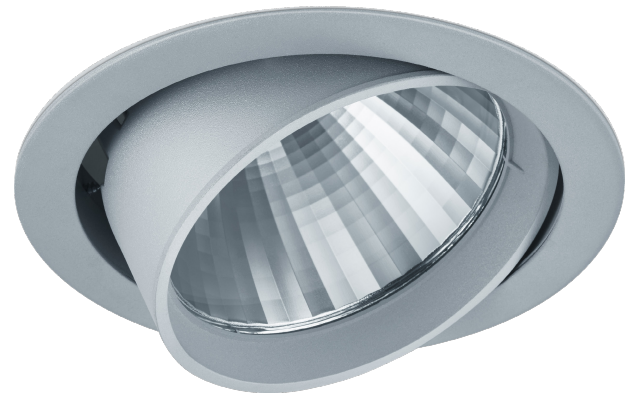

-  175 mm
-  160 mm
-  150 mm
-  2 x 40°
-  350°



 Made in Germany





Pavo XS

- LED Einbauleuchte 2 x 40° schwenkbar
 - Philips Fortimo LED SLM - Beste Lichtqualität für alle Anwendungen
 - Inkl. Treiber
 - Leuchten-Material: Aluminium
 - Pulverbeschichtet
 - Reflektoren aus 99,9 % Reinstaluminium
 - Schutzglas schützt Chip und Reflektor vor Verunreinigungen
 - Bajonettfrontring für werkzeuglosen Reflektorwechsel
 - Passive Kühlung
 - Auf Anfrage: Andere RAL-Farben, DALI, CASAMBI, Farbfilter, Wabenraster, Ausgleichsrahmen
-
- LED recessed luminaire 2 x 40° adjustable
 - Philips Fortimo LED SLM - Best quality of light available for all applications
 - Incl. driver
 - Luminaire-material: aluminium
 - Powder coated
 - Reflectors made of pure aluminium 99,9 %
 - Clear glass protects chip and reflector against dust and dirt
 - Twist and lock frontring for change reflectors without any tools
 - Passive cooling
 - Upon demand: Other RAL-color, DALI, CASAMBI, color filter, honeycomb, Downlight-Adapter

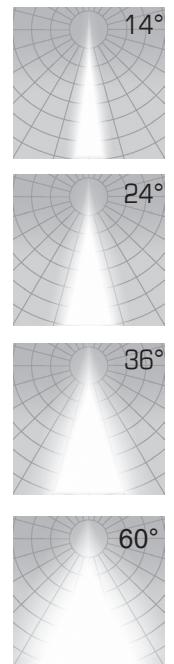



Ausstrahlwinkel / beam angle

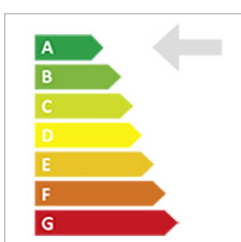

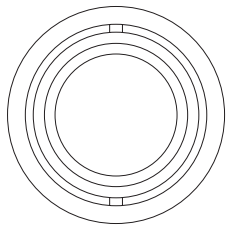
- Standard RAL
-  9006 silber / silver
 -  9005 schwarz / black
 -  9016 weiß / white





-  230 mm
-  175 mm
-  150 mm
-  2 x 40°



 Made in Germany





Pavo XL

- LED Einbauleuchte kardanisich 2 x 40° schwenkbar
 - Philips Fortimo LED SLM - Beste Lichtqualität für alle Anwendungen
 - Inkl. Treiber
 - Leuchten-Material: Aluminium
 - Pulverbeschichtet
 - Reflektoren aus 99,9 % Reinstaluminium
 - Schutzglas schützt Chip und Reflektor vor Verunreinigungen
 - Bajonettfrontring für werkzeuglosen Reflektorwechsel
 - Passive Kühlung
 - Auf Anfrage: Andere RAL-Farben, DALI, CASAMBI, Farbfilter, Wabenraster, Ausgleichsrahmen
-
- LED recessed luminaire gimbaled 2 x 40° adjustable
 - Philips Fortimo LED SLM - Best quality of light available for all applications
 - Incl. driver
 - Luminaire-material: aluminium
 - Powder coated
 - Reflectors made of pure aluminium 99,9 %
 - Clear glass protects chip and reflector against dust and dirt
 - Twist and lock frontring for change reflectors without any tools
 - Passive cooling
 - Upon demand: Other RAL-color, DALI, CASAMBI, color filter, honeycomb, Downlight-Adapter

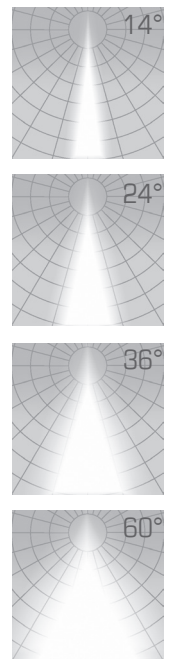
Ausstrahlwinkel
beam angle



- Standard RAL
-  9006 silber / silver
 -  9005 schwarz / black
 -  9016 weiß / white

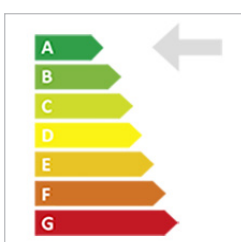

-  193 x 375 mm
-  175 x 355mm
-  150 mm
-  2 x 40°

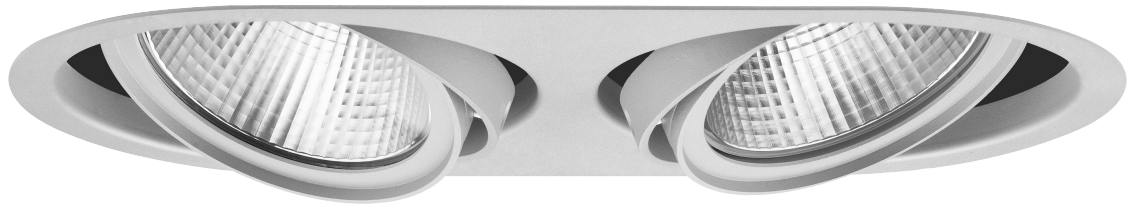

 Made in Germany





Pavo 2

- LED Einbauleuchte kardanisich 2 x 40° schwenkbar
 - Philips Fortimo LED SLM - Beste Lichtqualität für alle Anwendungen
 - Inkl. Treiber
 - Leuchten-Material: Aluminium
 - Pulverbeschichtet
 - Reflektoren aus 99,9 % Reinstaluminium
 - Schutzglas schützt Chip und Reflektor vor Verunreinigungen
 - Bajonettfrontring für werkzeuglosen Reflektorwechsel
 - Passive Kühlung
 - Auf Anfrage: Andere RAL-Farben, DALI, CASAMBI, Farbfilter, Wabenraster, Ausgleichsrahmen
-
- LED recessed luminaire gimbaled 2 x 40° adjustable
 - Philips Fortimo LED SLM - Best quality of light available for all applications
 - Incl. driver
 - Luminaire-material: aluminium
 - Powder coated
 - Reflectors made of pure aluminium 99,9 %
 - Clear glass protects chip and reflector against dust and dirt
 - Twist and lock frontring for change reflectors without any tools
 - Passive cooling
 - Upon demand: Other RAL-color, DALI, CASAMBI, color filter, honeycomb, Downlight-Adapter

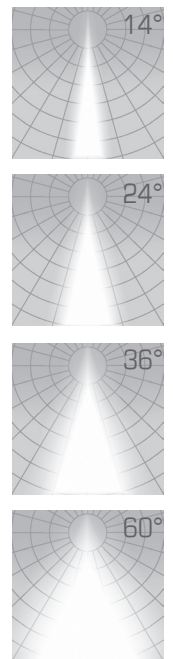
Ausstrahlwinkel
beam angle



Standard RAL

-  9006 silber / silver
-  9005 schwarz / black
-  9016 weiß / white



-  193 x 560 mm
-  175 x 535 mm
-  150 mm
-  2 x 40°



 Made in Germany





Pavo 3

- LED Einbauleuchte kardanisich 2 x 40° schwenkbar
 - Philips Fortimo LED SLM - Beste Lichtqualität für alle Anwendungen
 - Inkl. Treiber
 - Leuchten-Material: Aluminium
 - Pulverbeschichtet
 - Reflektoren aus 99,9 % Reinstaluminium
 - Schutzglas schützt Chip und Reflektor vor Verunreinigungen
 - Bajonettfrontring für werkzeuglosen Reflektorwechsel
 - Passive Kühlung
 - Auf Anfrage: Andere RAL-Farben, DALI, CASAMBI, Farbfilter, Wabenraster, Ausgleichsrahmen
-
- LED recessed luminaire gimbaled 2 x 40° adjustable
 - Philips Fortimo LED SLM - Best quality of light available for all applications
 - Incl. driver
 - Luminaire-material: aluminium
 - Powder coated
 - Reflectors made of pure aluminium 99,9 %
 - Clear glass protects chip and reflector against dust and dirt
 - Twist and lock frontring for change reflectors without any tools
 - Passive cooling
 - Upon demand: Other RAL-color, DALI, CASAMBI, color filter, honeycomb, Downlight-Adapter

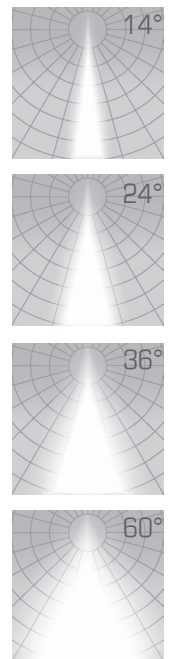
Ausstrahlwinkel
beam angle



Standard RAL

-  9006 silber / silver
-  9005 schwarz / black
-  9016 weiß / white

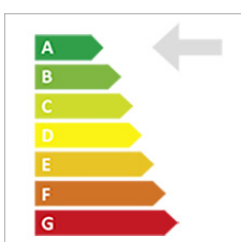



-  238 x 145 mm
-  200 x 130 mm
-  100 mm



 Made in Germany





Wall

- LED Einbauleuchte 60° ausschwenkbar
- Philips Fortimo LED SLM - Beste Lichtqualität für alle Anwendungen
- Inkl. Treiber
- Leuchten-Material: Aluminium
- Pulverbeschichtet
- Reflektoren aus 99,9 % Reinstaluminium
- Schutzglas schützt Chip und Reflektor vor Verunreinigungen
- Passive Kühlung
- Auf Anfrage: Andere RAL-Farben, DALI, CASAMBI, Farbfilter, Ausgleichsrahmen

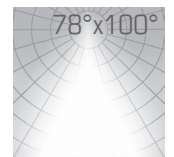
Ausstrahlwinkel
beam angle



Standard RAL

-  9006 silber / silver
-  9005 schwarz / black
-  9016 weiß / white

- LED recessed luminaire 60° adjustable
- Philips Fortimo LED SLM - Best quality of light available for all applications
- Incl. driver
- Luminaire-material: aluminium
- Powder coated
- Reflectors made of pure aluminium 99,9 %
- Clear glass protects chip and reflector against dust and dirt
- Passive cooling
- Upon demand: Other RAL-color, DALI, CASAMBI, color filter, Downlight-Adapter



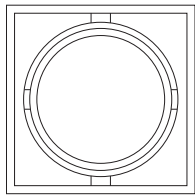

-  150 x 150 mm
-  140 x 140 mm
-  160 mm
-  2 x 40°



 Made in Germany





Doro XS1

- LED Einbauleuchte kardanisich 2 x 40° schwenkbar
 - Philips Fortimo LED SLM - Beste Lichtqualität für alle Anwendungen
 - Inkl. Treiber
 - Leuchten-Material: Aluminium
 - Pulverbeschichtet
 - Reflektoren aus 99,9 % Reinstaluminium
 - Schutzglas schützt Chip und Reflektor vor Verunreinigungen
 - Bajonettfrontring für werkzeuglosen Reflektorwechsel
 - Passive Kühlung
 - Auf Anfrage: Andere RAL-Farben, DALI, CASAMBI, Farbfilter, Wabenraster, Ausgleichsrahmen
-
- LED recessed luminaire gimbaled 2 x 40° adjustable
 - Philips Fortimo LED SLM - Best quality of light available for all applications
 - Incl. driver
 - Luminaire-material: aluminium
 - Powder coated
 - Reflectors made of pure aluminium 99,9 %
 - Clear glass protects chip and reflector against dust and dirt
 - Twist and lock frontring for change reflectors without any tools
 - Passive cooling
 - Upon demand: Other RAL-color, DALI, CASAMBI, color filter, honeycomb, Downlight-Adapter

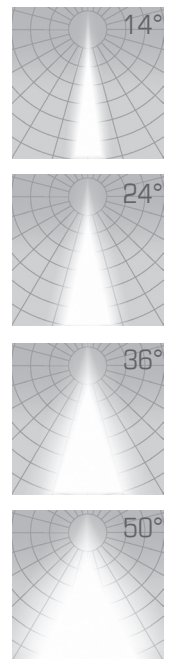
Ausstrahlwinkel
beam angle





- Standard RAL
-  9006 silber / silver
 -  9005 schwarz / black
 -  9016 weiß / white

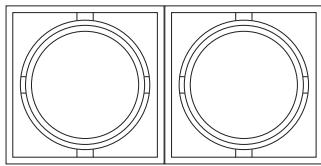

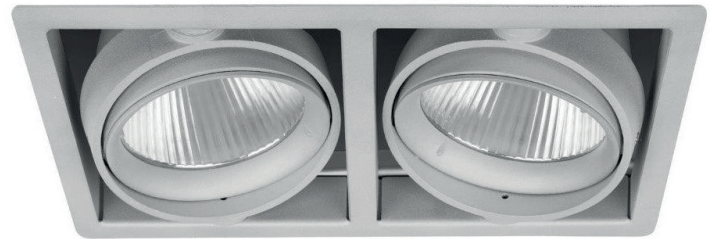

-  150 x 273 mm
-  140 x 255 mm
-  160 mm
-  2 x 40°



 Made in Germany





Doro XS2

- LED Einbauleuchte kardanisch 2 x 40° schwenkbar
 - Philips Fortimo LED SLM - Beste Lichtqualität für alle Anwendungen
 - Inkl. Treiber
 - Leuchten-Material: Aluminium
 - Pulverbeschichtet
 - Reflektoren aus 99,9 % Reinstaluminium
 - Schutzglas schützt Chip und Reflektor vor Verunreinigungen
 - Bajonettfrontring für werkzeuglosen Reflektorwechsel
 - Passive Kühlung
 - Auf Anfrage: Andere RAL-Farben, DALI, CASAMBI, Farbfilter, Wabenraster, Ausgleichsrahmen
-
- LED recessed luminaire gimballed 2 x 40° adjustable
 - Philips Fortimo LED SLM - Best quality of light available for all applications
 - Incl. driver
 - Luminaire-material: aluminium
 - Powder coated
 - Reflectors made of pure aluminium 99,9 %
 - Clear glass protects chip and reflector against dust and dirt
 - Twist and lock frontring for change reflectors without any tools
 - Passive cooling
 - Upon demand: Other RAL-color, DALI, CASAMBI, color filter, honeycomb, Downlight-Adapter

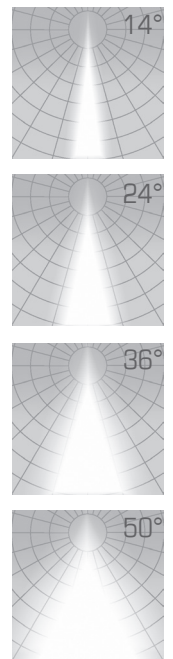
Ausstrahlwinkel
beam angle



Standard RAL

-  9006 silber / silver
-  9005 schwarz / black
-  9016 weiß / white

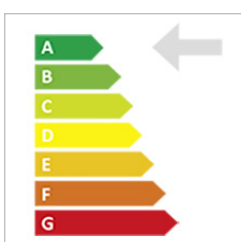

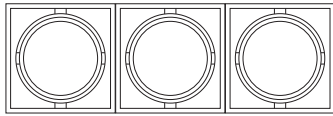

-  150 x 396 mm
-  140 x 370 mm
-  160 mm
-  2 x 40°



 Made in Germany





Doro XS3

- LED Einbauleuchte kardanisch 2 x 40° schwenkbar
 - Philips Fortimo LED SLM - Beste Lichtqualität für alle Anwendungen
 - Inkl. Treiber
 - Leuchten-Material: Aluminium
 - Pulverbeschichtet
 - Reflektoren aus 99,9 % Reinstaluminium
 - Schutzglas schützt Chip und Reflektor vor Verunreinigungen
 - Bajonettfrontring für werkzeuglosen Reflektorwechsel
 - Passive Kühlung
 - Auf Anfrage: Andere RAL-Farben, DALI, CASAMBI, Farbfilter, Wabenraster, Ausgleichsrahmen
-
- LED recessed luminaire gimballed 2 x 40° adjustable
 - Philips Fortimo LED SLM - Best quality of light available for all applications
 - Incl. driver
 - Luminaire-material: aluminium
 - Powder coated
 - Reflectors made of pure aluminium 99,9 %
 - Clear glass protects chip and reflector against dust and dirt
 - Twist and lock frontring for change reflectors without any tools
 - Passive cooling
 - Upon demand: Other RAL-color, DALI, CASAMBI, color filter, honeycomb, Downlight-Adapter

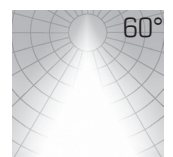
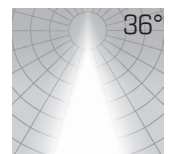
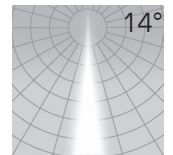
Ausstrahlwinkel /
beam angle



Standard RAL

-  9006 silber / silver
-  9005 schwarz / black
-  9016 weiß / white



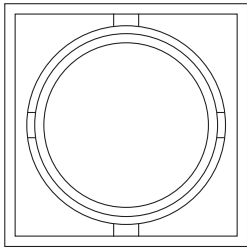

-  200 x 200 mm
-  180 x 180 mm
-  150 mm
-  2 x 40°



 Made in Germany





Doro 1

- LED Einbauleuchte kardanisch 2 x 40° schwenkbar
 - Philips Fortimo LED SLM - Beste Lichtqualität für alle Anwendungen
 - Inkl. Treiber
 - Leuchten-Material: Aluminium
 - Pulverbeschichtet
 - Reflektoren aus 99,9 % Reinstaluminium
 - Schutzglas schützt Chip und Reflektor vor Verunreinigungen
 - Bajonettfrontring für werkzeuglosen Reflektorwechsel
 - Passive Kühlung
 - Auf Anfrage: Andere RAL-Farben, DALI, CASAMBI, Farbfilter, Wabenraster, Ausgleichsrahmen
-
- LED recessed luminaire gimbaled 2 x 40° adjustable
 - Philips Fortimo LED SLM - Best quality of light available for all applications
 - Incl. driver
 - Luminaire-material: aluminium
 - Powder coated
 - Reflectors made of pure aluminium 99,9 %
 - Clear glass protects chip and reflector against dust and dirt
 - Twist and lock frontring for change reflectors without any tools
 - Passive cooling
 - Upon demand: Other RAL-color, DALI, CASAMBI, color filter, honeycomb, Downlight-Adapter

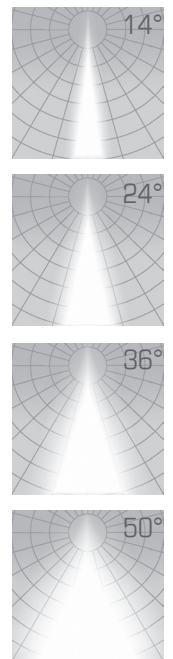
Ausstrahlwinkel
beam angle



Standard RAL

-  9006 silber / silver
-  9005 schwarz / black
-  9016 weiß / white

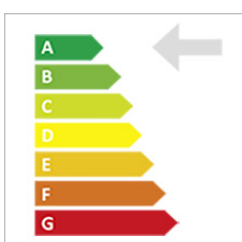

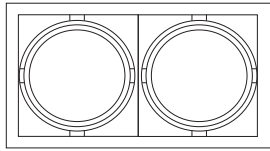

-  200 x 365 mm
-  180 x 335 mm
-  150 mm
-  2 x 40°

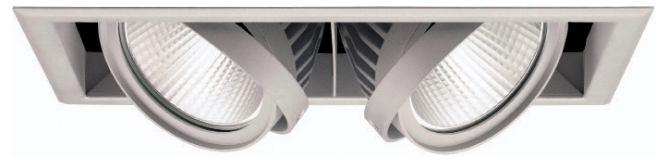

 Made in Germany





Doro 2

- LED Einbauleuchte kardanisich 2 x 40° schwenkbar
 - Philips Fortimo LED SLM - Beste Lichtqualität für alle Anwendungen
 - Inkl. Treiber
 - Leuchten-Material: Aluminium
 - Pulverbeschichtet
 - Reflektoren aus 99,9 % Reinstaluminium
 - Schutzglas schützt Chip und Reflektor vor Verunreinigungen
 - Bajonettfrontring für werkzeuglosen Reflektorwechsel
 - Passive Kühlung
 - Auf Anfrage: Andere RAL-Farben, DALI, CASAMBI, Farbfilter, Wabenraster, Ausgleichsrahmen
-
- LED recessed luminaire gimbaled 2 x 40° adjustable
 - Philips Fortimo LED SLM - Best quality of light available for all applications
 - Incl. driver
 - Luminaire-material: aluminium
 - Powder coated
 - Reflectors made of pure aluminium 99,9 %
 - Clear glass protects chip and reflector against dust and dirt
 - Twist and lock frontring for change reflectors without any tools
 - Passive cooling
 - Upon demand: Other RAL-color, DALI, CASAMBI, color filter, honeycomb, Downlight-Adapter

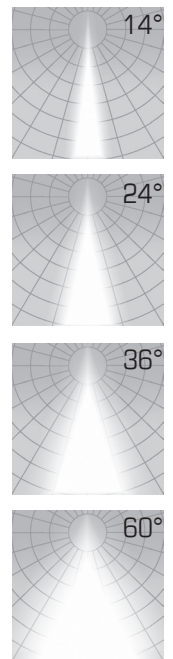
Ausstrahlwinkel / beam angle



- Standard RAL
-  9006 silber / silver
 -  9005 schwarz / black
 -  9016 weiß / white



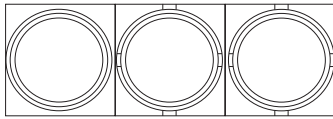

-  200 x 530 mm
-  180 x 500 mm
-  150 mm
-  2 x 40°



 Made in Germany





Doro 3

- LED Einbauleuchte kardanisch 2 x 40° schwenkbar
 - Philips Fortimo LED SLM - Beste Lichtqualität für alle Anwendungen
 - Inkl. Treiber
 - Leuchten-Material: Aluminium
 - Pulverbeschichtet
 - Reflektoren aus 99,9 % Reinstaluminium
 - Schutzglas schützt Chip und Reflektor vor Verunreinigungen
 - Bajonettfrontring für werkzeuglosen Reflektorwechsel
 - Passive Kühlung
 - Auf Anfrage: Andere RAL-Farben, DALI, CASAMBI, Farbfilter, Wabenraster, Ausgleichsrahmen
-
- LED recessed luminaire gimballed 2 x 40° adjustable
 - Philips Fortimo LED SLM - Best quality of light available for all applications
 - Incl. driver
 - Luminaire-material: aluminium
 - Powder coated
 - Reflectors made of pure aluminium 99,9 %
 - Clear glass protects chip and reflector against dust and dirt
 - Twist and lock frontring for change reflectors without any tools
 - Passive cooling
 - Upon demand: Other RAL-color, DALI, CASAMBI, color filter, honeycomb, Downlight-Adapter

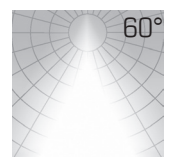
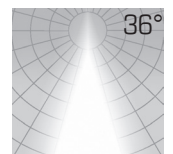
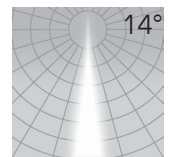
Ausstrahlwinkel / beam angle



Standard RAL

-  9006 silber / silver
-  9005 schwarz / black
-  9016 weiß / white

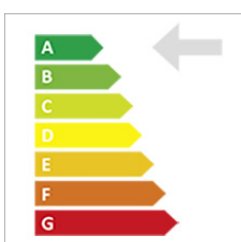

-  174 mm
-  155 mm
-  100 mm



 Made in Germany





Down 174

- LED Einbauleuchte starr
 - Philips Fortimo LED SLM - Beste Lichtqualität für alle Anwendungen
 - Inkl. Treiber
 - Leuchten-Material: Aluminium
 - Pulverbeschichtet
 - Reflektoren aus 99,9 % Reinstaluminium
 - Schutzglas schützt Chip und Reflektor vor Verunreinigungen
 - Bajonettfrontring für werkzeuglosen Reflektorwechsel
 - Passive Kühlung
 - Auf Anfrage: Andere RAL-Farben, DALI, CASAMBI, Farbfilter, Wabenraster, Ausgleichsrahmen
-
- LED recessed luminaire not adjustable
 - Philips Fortimo LED SLM - Best quality of light available for all applications
 - Incl. driver
 - Luminaire-material: aluminium
 - Powder coated
 - Reflectors made of pure aluminium 99,9 %
 - Clear glass protects chip and reflector against dust and dirt
 - Twist and lock frontring for change reflectors without any tools
 - Passive cooling
 - Upon demand: Other RAL-color, DALI, CASAMBI, color filter, honeycomb, Downlight-Adapter

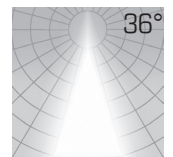
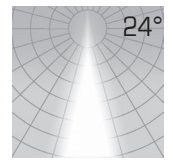
Ausstrahlwinkel /
beam angle



Standard RAL

-  9006 silber / silver
-  9005 schwarz / black
-  9016 weiß / white

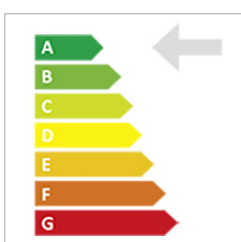

-  230 mm
-  205 mm
-  110 mm







 220-240V
50-60Hz
  1,25 kg
  ALU





 Made in Germany



PHILIPS
INSIDE

Down 230

- LED Einbauleuchte starr
 - Philips Fortimo LED SLM - Beste Lichtqualität für alle Anwendungen
 - Inkl. Treiber
 - Leuchten-Material: Aluminium
 - Pulverbeschichtet
 - Reflektoren aus 99,9 % Reinstaluminium
 - Schutzglas schützt Chip und Reflektor vor Verunreinigungen
 - Bajonettfrontring für werkzeuglosen Reflektorwechsel
 - Passive Kühlung
 - Auf Anfrage: Andere RAL-Farben, DALI, CASAMBI, Farbfilter, Wabenraster, Ausgleichsrahmen
-
- LED recessed luminaire not adjustable
 - Philips Fortimo LED SLM - Best quality of light available for all applications
 - Incl. driver
 - Luminaire-material: aluminium
 - Powder coated
 - Reflectors made of pure aluminium 99,9 %
 - Clear glass protects chip and reflector against dust and dirt
 - Twist and lock frontring for change reflectors without any tools
 - Passive cooling
 - Upon demand: Other RAL-color, DALI, CASAMBI, color filter, honeycomb, Downlight-Adapter

Ausstrahlwinkel /
beam angle



- Standard RAL
-  9006 silber / silver
 -  9005 schwarz / black
 -  9016 weiß / white

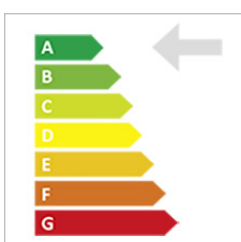

-  260 mm
-  235 mm
-  120 mm







 220-240V
50-60Hz
  1.50kg
  ALU





 Made in Germany





Down 260

- LED Einbauleuchte starr
 - Philips Fortimo LED SLM - Beste Lichtqualität für alle Anwendungen
 - Inkl. Treiber
 - Leuchten-Material: Aluminium
 - Pulverbeschichtet
 - Reflektoren aus 99,9 % Reinstaluminium
 - Schutzglas schützt Chip und Reflektor vor Verunreinigungen
 - Bajonettfrontring für werkzeuglosen Reflektorwechsel
 - Passive Kühlung
 - Auf Anfrage: Andere RAL-Farben, DALI, CASAMBI, Farbfilter, Wabenraster, Ausgleichsrahmen
-
- LED recessed luminaire not adjustable
 - Philips Fortimo LED SLM - Best quality of light available for all applications
 - Incl. driver
 - Luminaire-material: aluminium
 - Powder coated
 - Reflectors made of pure aluminium 99,9 %
 - Clear glass protects chip and reflector against dust and dirt
 - Twist and lock frontring for change reflectors without any tools
 - Passive cooling
 - Upon demand: Other RAL-color, DALI, CASAMBI, color filter, honeycomb, Downlight-Adapter

Ausstrahlwinkel /
beam angle



Standard RAL

-  9006 silber / silver
-  9005 schwarz / black
-  9016 weiß / white

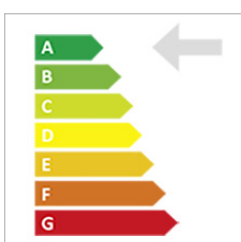

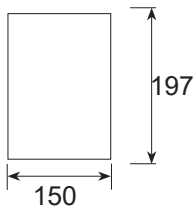

 2 x 15°



 Made in Germany





Doro A 150

- Aufbauleuchte kardanisch schwenkbar
 - Philips Fortimo LED SLM - Beste Lichtqualität für alle Anwendungen
 - Strahler-Material: Aluminium
 - Pulverbeschichtet
 - Reflektoren aus 99,9 % Reinstaluminium
 - Schutzglas schützt Chip und Reflektor vor Verunreinigungen
 - Bajonettfrontring für werkzeuglosen Reflektorwechsel
 - Passive Kühlung
 - Auf Anfrage: Andere RAL-Farben, DALI, CASAMBI, Farbfilter, Wabenraster
-
- Built-up luminaire cardanic
 - Philips Fortimo LED SLM - Best quality of light available for all applications
 - Spotlight-material: aluminium
 - Powder coated
 - Reflectors made of pure aluminium 99,9 %
 - Clear glass protects chip and reflector against dust and dirt
 - Twist and lock frontring for change reflectors without any tools
 - Passive cooling
 - Upon demand: Other RAL-color, DALI, CASAMBI, color filter, honeycomb

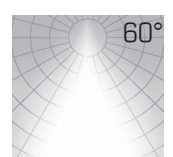
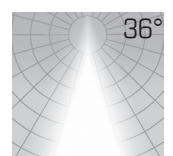
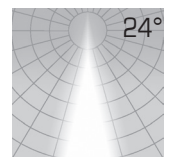
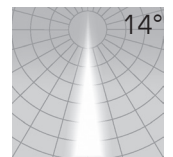
Ausstrahlwinkel /
beam angle



Standard RAL

-  9006 silber / silver
-  9005 schwarz / black
-  9016 weiß / white



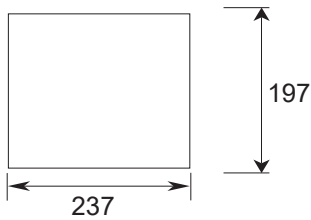

 2 x 40°



 Made in Germany





Doro A 237

- Aufbauleuchte kardanisch schwenkbar
 - Philips Fortimo LED SLM - Beste Lichtqualität für alle Anwendungen
 - Strahler-Material: Aluminium
 - Pulverbeschichtet
 - Reflektoren aus 99,9 % Reinaluminium
 - Schutzglas schützt Chip und Reflektor vor Verunreinigungen
 - Bajonettfrontring für werkzeuglosen Reflektorwechsel
 - Passive Kühlung
 - Auf Anfrage: Andere RAL-Farben, DALI, CASAMBI, Farbfilter, Wabenraster
-
- Built-up luminaire cardanic
 - Philips Fortimo LED SLM - Best quality of light available for all applications
 - Spotlight-material: aluminium
 - Powder coated
 - Reflectors made of pure aluminium 99,9 %
 - Clear glass protects chip and reflector against dust and dirt
 - Twist and lock frontring for change reflectors without any tools
 - Passive cooling
 - Upon demand: Other RAL-color, DALI, CASAMBI, color filter, honeycomb

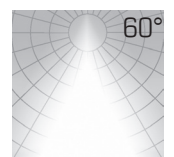
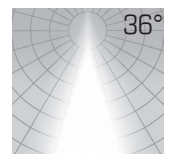
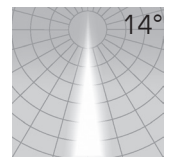
Ausstrahlwinkel /
beam angle



Standard RAL

-  9006 silber / silver
-  9005 schwarz / black
-  9016 weiß / white

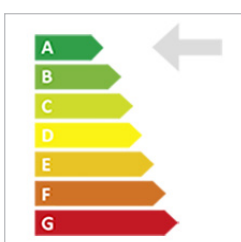

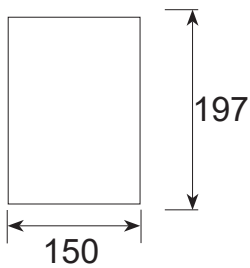

 2 x 15°



 Made in Germany





Doro P 150

- Aufbauleuchte kardanisch schwenkbar
 - Philips Fortimo LED SLM - Beste Lichtqualität für alle Anwendungen
 - Strahler-Material: Aluminium
 - Inkl. Seilaufhängung 2000 mm
 - Pulverbeschichtet
 - Reflektoren aus 99,9 % Reinstaluminium
 - Schutzglas schützt Chip und Reflektor vor Verunreinigungen
 - Bajonettfrontring für werkzeuglosen Reflektorwechsel
 - Passive Kühlung
 - Auf Anfrage: Andere RAL-Farben, DALI, CASAMBI, Farbfilter, Wabenraster
-
- Built-up luminaire cardanic
 - Philips Fortimo LED SLM - Best quality of light available for all applications
 - Spotlight-material: aluminium
 - incl. wire-suspension 2000 mm
 - Powder coated
 - Reflectors made of pure aluminium 99,9 %
 - Clear glass protects chip and reflector against dust and dirt
 - Twist and lock frontring for change reflectors without any tools
 - Passive cooling
 - Upon demand: Other RAL-color, DALI, CASAMBI, color filter, honeycomb

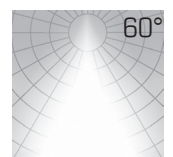
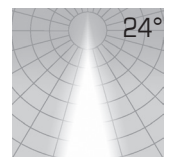
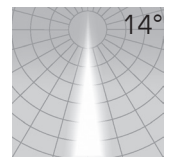
Ausstrahlwinkel /
beam angle



Standard RAL

-  9006 silber / silver
-  9005 schwarz / black
-  9016 weiß / white

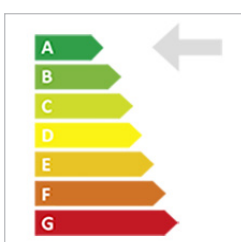

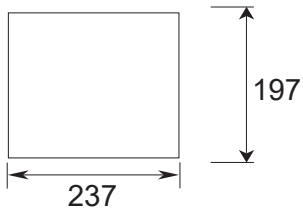

 2 x 40°



 Made in Germany





Doro P 237

- Aufbauleuchte kardanisch schwenkbar
 - Philips Fortimo LED SLM - Beste Lichtqualität für alle Anwendungen
 - Strahler-Material: Aluminium
 - Inkl. Seilaufhängung 2000 mm
 - Pulverbeschichtet
 - Reflektoren aus 99,9 % Reinstaluminium
 - Schutzglas schützt Chip und Reflektor vor Verunreinigungen
 - Bajonettfrontring für werkzeuglosen Reflektorwechsel
 - Passive Kühlung
 - Auf Anfrage: Andere RAL-Farben, DALI, CASAMBI, Farbfilter, Wabenraster
-
- Built-up luminaire cardanic
 - Philips Fortimo LED SLM - Best quality of light available for all applications
 - Spotlight-material: aluminium
 - incl. wire-suspension 2000 mm
 - Powder coated
 - Reflectors made of pure aluminium 99,9 %
 - Clear glass protects chip and reflector against dust and dirt
 - Twist and lock frontring for change reflectors without any tools
 - Passive cooling
 - Upon demand: Other RAL-color, DALI, CASAMBI, color filter, honeycomb

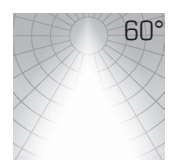
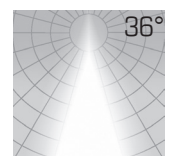
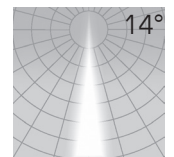
Ausstrahlwinkel /
beam angle



Standard RAL

-  9006 silber / silver
-  9005 schwarz / black
-  9016 weiß / white

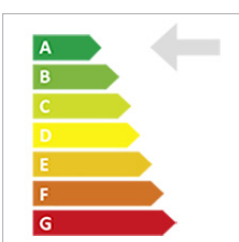

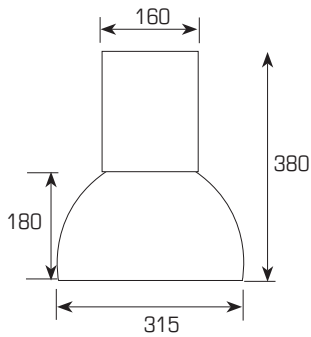



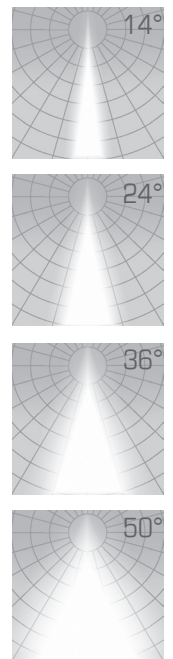

Factory

- LED Pendelleuchte
 - Philips Fortimo LED SLM - Beste Lichtqualität für alle Anwendungen
 - Inkl. Treiber
 - Leuchten-Material: Aluminium
 - Pulverbeschichtet
 - Reflektoren aus 99,9 % Reinstaluminium
 - Schutzglas schützt Chip und Reflektor vor Verunreinigungen
 - Bajonettfrontring für werkzeuglosen Reflektorwechsel
 - Passive Kühlung
 - Auf Anfrage: Andere RAL-Farben, DALI, CASAMBI, Farbfilter, Wabenraster
-
- LED pendant luminaire
 - Philips Fortimo LED SLM - Best quality of light available for all applications
 - Incl. driver
 - Luminaire-material: aluminium
 - Powder coated
 - Reflectors made of pure aluminium 99,9 %
 - Clear glass protects chip and reflector against dust and dirt
 - Twist and lock frontring for change reflectors without any tools
 - Passive cooling
 - Upon demand: Other RAL-color, DALI, CASAMBI, color filter, honeycomb

Ausstrahlwinkel
beam angle



Standard RAL

	9006 silber / silver
	9005 schwarz / black
	9016 weiß / white

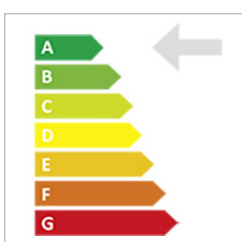

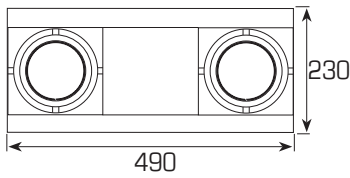

 2 x 40°

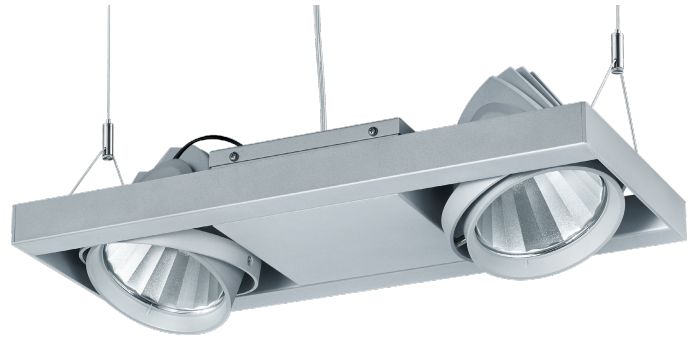

 Made in Germany





Sina P2

- LED Pendelleuchte kardanisch 2 x 40° schwenkbar
 - Philips Fortimo LED SLM - Beste Lichtqualität für alle Anwendungen
 - Inkl. Treiber
 - Leuchten-Material: Aluminium
 - Pulverbeschichtet
 - Reflektoren aus 99,9 % Reinstaluminium
 - Schutzglas schützt Chip und Reflektor vor Verunreinigungen
 - Bajonettfrontring für werkzeuglosen Reflektorwechsel
 - Passive Kühlung
 - Auf Anfrage: Andere RAL-Farben, DALI, CASAMBI, Farbfilter, Wabenraster
-
- LED pendant luminaire gimballed 2 x 40° adjustable
 - Philips Fortimo LED SLM - Best quality of light available for all applications
 - Incl. driver
 - Luminaire-material: aluminium
 - Powder coated
 - Reflectors made of pure aluminium 99,9 %
 - Clear glass protects chip and reflector against dust and dirt
 - Twist and lock frontring for change reflectors without any tools
 - Passive cooling
 - Upon demand: Other RAL-color, DALI, CASAMBI, color filter, honeycomb

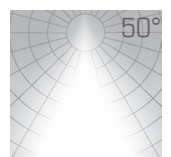
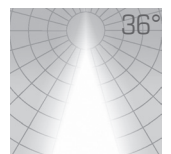
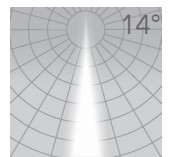
Ausstrahlwinkel
beam angle



Standard RAL

-  9006 silber / silver
-  9005 schwarz / black
-  9016 weiß / white



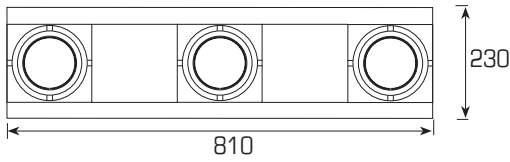

 2 x 40°



 Made in Germany





Sina P3

- LED Pendelleuchte kardanisch 2 x 40° schwenkbar
 - Philips Fortimo LED SLM - Beste Lichtqualität für alle Anwendungen
 - Inkl. Treiber
 - Leuchten-Material: Aluminium
 - Pulverbeschichtet
 - Reflektoren aus 99,9 % Reinstaluminium
 - Schutzglas schützt Chip und Reflektor vor Verunreinigungen
 - Bajonettfrontring für werkzeuglosen Reflektorwechsel
 - Passive Kühlung
 - Auf Anfrage: Andere RAL-Farben, DALI, CASAMBI, Farbfilter, Wabenraster
-
- LED pendant luminaire gimballed 2 x 40° adjustable
 - Philips Fortimo LED SLM - Best quality of light available for all applications
 - Incl. driver
 - Luminaire-material: aluminium
 - Powder coated
 - Reflectors made of pure aluminium 99,9 %
 - Clear glass protects chip and reflector against dust and dirt
 - Twist and lock frontring for change reflectors without any tools
 - Passive cooling
 - Upon demand: Other RAL-color, DALI, CASAMBI, color filter, honeycomb

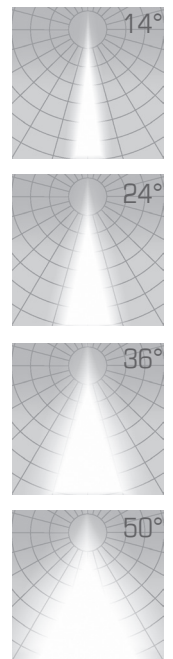
Ausstrahlwinkel
beam angle



Standard RAL

-  9006 silber / silver
-  9005 schwarz / black
-  9016 weiß / white



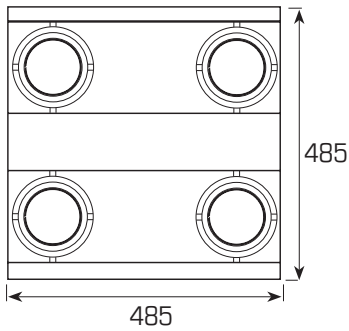

 2 x 40°

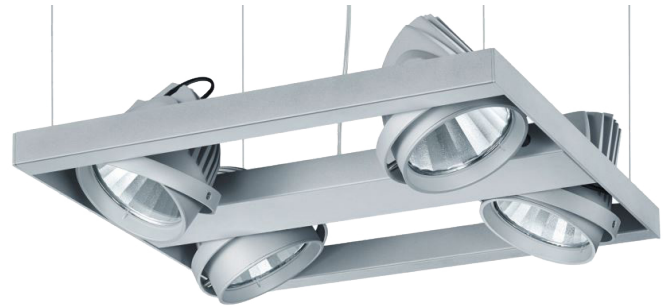

 Made in Germany





Sina P4

- LED Pendelleuchte kardanisch 2 x 40° schwenkbar
 - Philips Fortimo LED SLM - Beste Lichtqualität für alle Anwendungen
 - Inkl. Treiber
 - Leuchten-Material: Aluminium
 - Pulverbeschichtet
 - Reflektoren aus 99,9 % Reinstaluminium
 - Schutzglas schützt Chip und Reflektor vor Verunreinigungen
 - Bajonettfrontring für werkzeuglosen Reflektorwechsel
 - Passive Kühlung
 - Auf Anfrage: Andere RAL-Farben, DALI, CASAMBI, Farbfilter, Wabenraster
-
- LED pendant luminaire gimballed 2 x 40° adjustable
 - Philips Fortimo LED SLM - Best quality of light available for all applications
 - Incl. driver
 - Luminaire-material: aluminium
 - Powder coated
 - Reflectors made of pure aluminium 99,9 %
 - Clear glass protects chip and reflector against dust and dirt
 - Twist and lock frontring for change reflectors without any tools
 - Passive cooling
 - Upon demand: Other RAL-color, DALI, CASAMBI, color filter, honeycomb

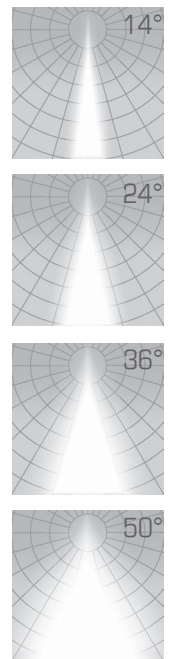
Ausstrahlwinkel
beam angle



- Standard RAL
-  9006 silber / silver
 -  9005 schwarz / black
 -  9016 weiß / white

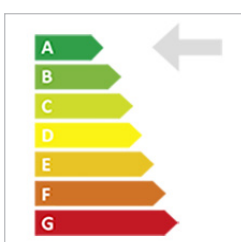

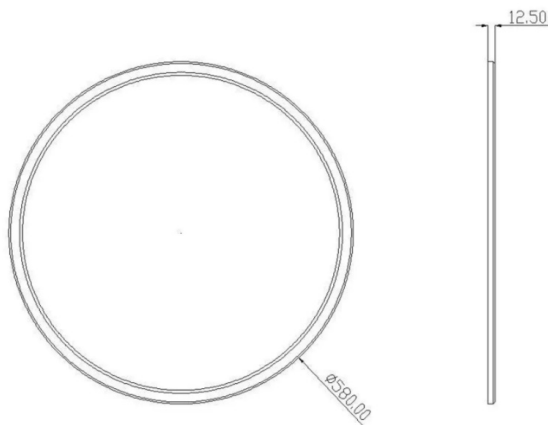

Round

Standard RAL

9016 weiß / white

- LED Pendelleuchte, rund, Durchmesser 600 mm
- Seilpendellänge max. 1500mm
- Gehäusefarbe weiss, pulverbeschichtet, andere Farben auf Anfrage lieferbar
- Lichtstrom 6000 Lumen
- 3000 Kelvin oder 4000 Kelvin
- Acrylglasabdeckung opalisiert sorgt für homogene Streuung
- inkl. Treiber
- Abstrahlwinkel 120°

- LED Pendant Light , round, Diameter 600mm
- Pendant Length max. 1500mm
- Housing white, powder coatet, other colors available on request
- Luminous flux 6000 Lumen
- 3000 Kelvin oder 4000 Kelvin
- opal acrylic glass cover, ensures homogeneous scattering
- incl. power gear
- Beam Angle 120°



**Lichtkanalsysteme, Ringleuchten, Sonderanfertigungen...?
Wir können das!**

**Kommen Sie mit Ihren Vorstellungen gerne auf uns zu - wir haben
die Lösung.**





Swizz-Light

Swizz-Light GmbH
Gehrenstrasse 12
4227 Büsserach

Phone: + 41 62 874 04 04

Mobile: +41 79 778 21 65

Fax: + 41 62 874 34 05

E-Mail: info@swizz-light.ch

Internet: www.swizz-light.ch

...we light you up