

BEx1 IP67 | TOUGH ENOUGH TO WORK FOR YOU



High integration

- Worldwide Ex approved*
- Maritime approved
- Standardization
- Small footprint
- Decentralized installation
- Scalable
- Easy software integration

Cost and time saving

- Less engineering
- Speed up commissioning
- Shorter time to market
- Reducing installation
- Reducing down times

Multifunction of Pin 1 Ex i

DO - Digital output



AO - Analog output

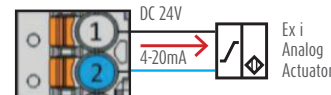

AI - Analog input

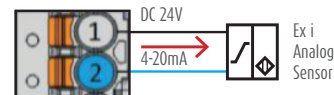

DI - Digital input (mechanical switch)

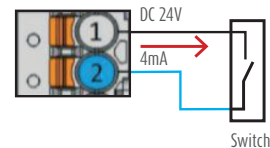

BEx-Solution GmbH
76199 Karlsruhe
Lange Str. 99 · Germany
T +49 (0) 721 60 90 45 33
M +49 (0) 152 54 22 23 74
info@bex-solution.com
bex-solution.com

BEx1 IP67 | ZONE 1 INSTALLATION ON THE NEXT LEVEL



Profinet IO modules IP 67 Ex i and Ex e

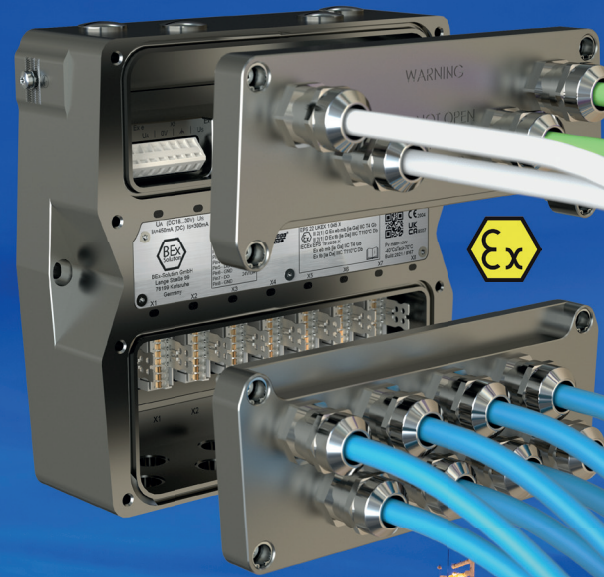

IECEx · ATEX · UKEX · North America · DNV ...



Fully integrated, tested and certified system for IECEx, ATEX, UKEX, North America, DNV ...*

zero cabinet



Ex i

Intrinsically safe I/O

16DI 8DO 8DO(AIO)
Type: 14310*01

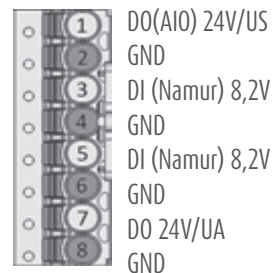

BEx1 IP67



Ex e

Increased safety I/O

8AI 8AO(DIO) 8DIO
Type: 15310*04

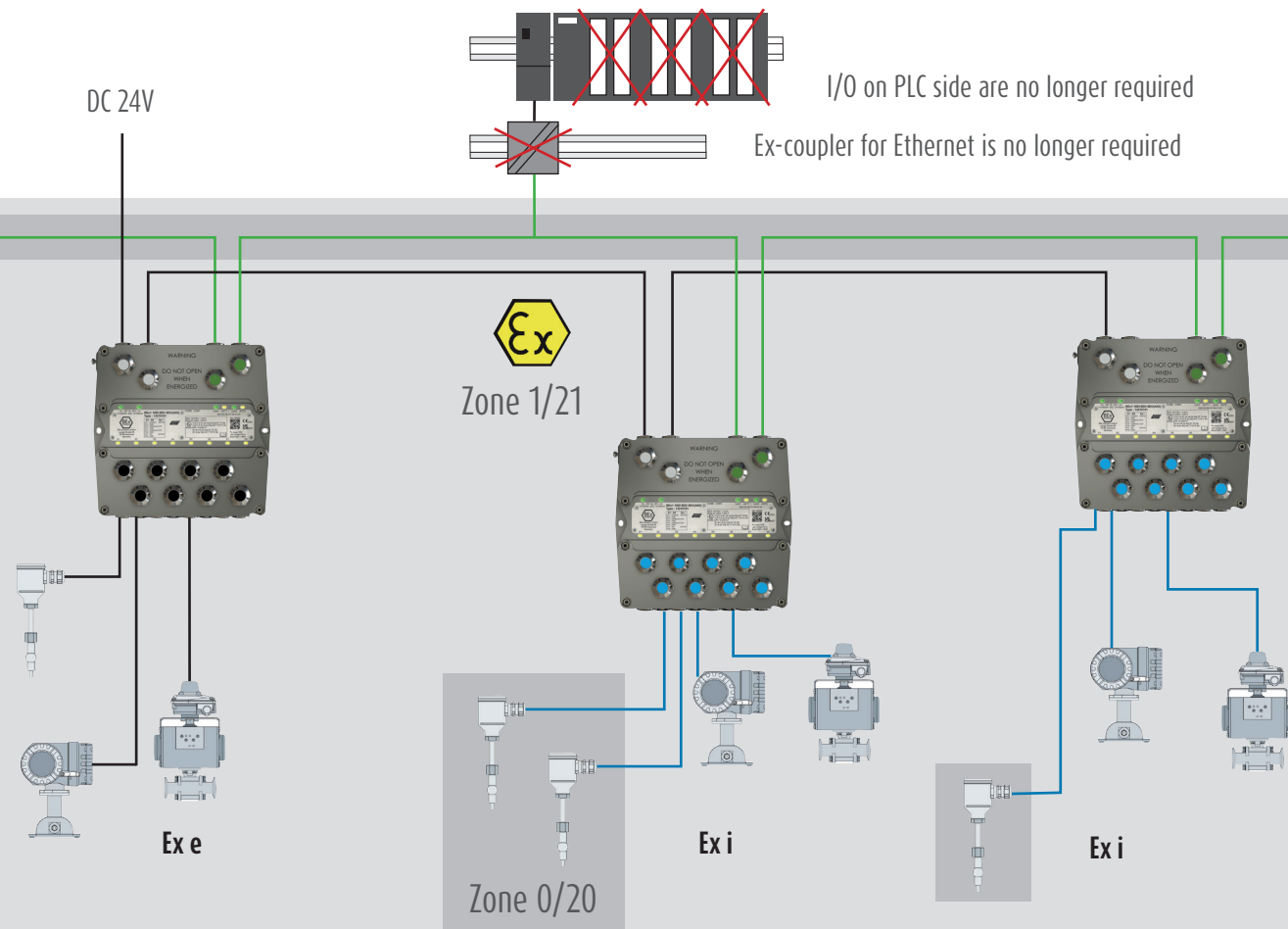
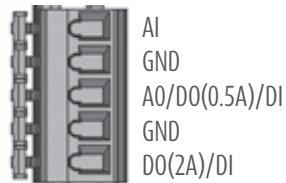

Profinet - Modbus TCP

Technical benefits

- Short connection to sensor and actuator
- Ex module and housing all in one
- Dust and waterproof IP67
- Integrated Ethernet switch
- Integrated isolation amplifier
- Visible diagnostics
- Extremely robust and compact design