

idc 

IDC® - Bearings
by INTERPRECISE Germany

Axial-Zylinderrollenlager

Cylindrical Roller Thrust Bearings

INTERPRECISE Donath GmbH
Ostring 2
90587 Obermichelbach
Germany

Telefon +49-911-76630-0
Telefax +49-911-76630-30

info@interprecise.de
www.idc-bearings.com



idc 

Axial-Zylinderrollenlager

Cylindrical Roller Thrust Bearings



Axial-Zylinderrollenlager

Cylindrical Roller Thrust Bearings

Allgemeines	4
Allgemeine Lagerdaten	4
Abmessungen	4
Betriebstemperatur	4
Härteverfahren	4
Grenzdrehzahl	4
Schiefstellung	5
Toleranzen	5
Äquivalente Lagerbelastungen	5
Axiale Mindestbelastung	6
Anschlusskonstruktion	6
Nachsetzzeichen	7
General Information	8
General Technical Bearing Information	8
Dimensions	8
Operation Temperature	8
Heat Treatment Process	8
Limiting Rotational Speed	8
Misalignment	9
Tolerances	9
Equivalent Bearing Load	9
Minimum Axial Load	9
Design of Associated Components	10
Suffixes	11
Baureihe / Series 811	12
Baureihe / Series 812	14
Baureihe / Series 893	16
Baureihe / Series 894	18





Axial-Zylinderrollenlager

Allgemeines

Axial-Zylinderrollenlager ermöglichen eine hohe axiale Belastbarkeit bei besonders geringer axialer Bauhöhe sowie hoher Steifigkeit und hoher Tragfähigkeit. Die Lager werden standardmäßig einseitig wirkend ausgeführt und sind in ein- und zweireihiger Ausführung erhältlich.

Die Lager setzen sich zusammen aus einer Wellenscheibe, einer Gehäusescheibe und einem Axial-Rollenkranz. Die Lagerteile sind auch einzeln lieferbar. Dies ist zweckmäßig, wenn z.B. die Laufbahnen in die Welle und/oder das Gehäuse integriert werden und somit die Wellenscheiben und/oder die Gehäusescheiben entfallen können.

Allgemeine Lagerdaten

Abmessungen

Die Hauptabmessungen der Axial-Zylinderrollenlager stimmen bei einreihigen Lagern (Baureihen 811 und 812) mit DIN 722 und bei zweireihigen Lagern (Baureihen 893 und 894) mit DIN 616 und ISO 104 überein.

Betriebstemperatur

Axial-Zylinderrollenlager können standardmäßig bei Betriebstemperaturen von -30 bis +150°C eingesetzt werden.

Ausgenommen sind Lager mit Kunststoffkäfig (Nachsetzzeichen TV). Hier ist die Betriebstemperatur auf -30 bis +120°C begrenzt.

Härteverfahren

Die Ringe und die Wälzkörper sind standardmäßig durchgehärtet.

Grenzdrehzahl

Die in den Datenblättern angegebenen Grenzdrehzahlen sind nur für Ölschmierung gültig. Wird eine Fettschmierung verwendet, so liegt die Grenzdrehzahl bei 25% des angegebenen Wertes.



Axial-Zylinderrollenlager

Schiefstellung

Bei Axial-Zylinderrollenlagern ist eine Schiefstellung zwischen Welle und Gehäuse bzw. eine Winkelabweichung zwischen den Auflageflächen an der Welle und im Gehäuse nicht zulässig.

Toleranzen

Axial-Zylinderrollenlager werden standardmäßig mit Toleranzklasse PN nach DIN 620-2 bzw. ISO 199 gefertigt. Auf Anfrage können die Lagerbauteile auch in der Toleranzklasse P5 gefertigt werden.

Die Toleranzen der Lagerbauteile sind im Folgenden tabellarisch aufgelistet:

		Toleranzen					
		Bohrung		Außendurchmesser		Höhe	
Axial-Rollenkränze	K	d	E11 ^{*1}	D	a13 ^{*1}	D _W	DIN 5402-1
Wellenscheiben	WS	d	DIN 620-3	d ₁	-	B	h11
Gehäusescheiben	GS	D ₁	-	D	DIN 620-3	B	h11

^{*1} Abweichung des mittleren Durchmessers

Äquivalente Lagerbelastungen

Dynamisch: $P = F_a$

Statisch: $P_0 = F_a$

Axiale Mindestbelastung

Bei Axial-Zylinderrollenlagern ist eine axiale Mindestbelastung erforderlich, um einen störungsfreien Betrieb zu gewährleisten. Dies gilt besonders bei hohen Drehzahlen und starken Beschleunigungen.

Die annähernde axiale Mindestbelastung errechnet sich wie folgt:

$$F_{a \min} = 0,0005 * C_{0a} + k_a * \left(\frac{C_{0a} * n}{10^3} \right)^2$$

Erklärungen:

$F_{a \min}$	axiale Mindestbelastung in N
C_{0a}	statische axiale Tragzahl in N
n	Betriebsdrehzahl in min^{-1}
k_a	Berechnungsbeiwert
	Baureihe 811 1,4
	Baureihe 812 0,9
	Baureihe 893 0,7
	Baureihe 894 0,5

Kann die errechnete axiale Mindestbelastung nicht erreicht werden, so sind die Lager vorzuspannen. Dies kann z.B. durch entsprechende Federn oder eine Wellenmutter erreicht werden.

Anschlusskonstruktion

Die Lagerscheiben sollten nach Möglichkeit über den gesamten Laufbahnbereich unterstützt sein. Die Anlageschultern sind steif und die Anlageflächen rechtwinklig und eben zur Drehachse auszuführen.

Die Axial-Rollenkäfige sollten nach Möglichkeit auf der Welle radial geführt werden. Dies ist insbesondere bei hohen Drehzahlen wichtig. Die Führungsflächen sind mit feinbearbeiteter und verschleißfester Oberfläche zu fertigen.

Werden die Axial-Rollenkränze ohne Wellen- und/oder Gehäusescheibe eingebaut, so ist darauf zu achten, dass die Anlaufflächen mit der für Wälzlager üblichen Oberflächenqualität und Härte herzustellen sind. Es sind außerdem geeignete Wälzlagerstähle zu verwenden. Für weitere Informationen wenden Sie sich bitte an uns.



Axial-Zylinderrollenlager

Die folgende Tabelle zeigt die Toleranzen, nach denen Wellen und Gehäusebohrungen zu fertigen sind.

		Toleranzen	
		Welle	Gehäusebohrung
Axial-Rollenkränze	K	h8	-
Wellenscheiben	WS	h8	-
Gehäusescheiben	GS	-	H9

Nachsetzzeichen

Die Nachsetzzeichen für die lieferbaren Ausführungen sind aus der folgenden Liste zu entnehmen:

M Massivkäfig aus Messing, rollengeführt *1

P5 Maß- und Lauftoleranzen kleiner als P6 *2

TV Käfig aus Polyamid 6.6, rollengeführt *1

*1 Käfigausführung ist abhängig von Baureihe und Baugröße

*2 auf Anfrage



Cylindrical Roller Thrust Bearings

General Information

Cylindrical Roller Thrust Bearings are suitable for high axial loads and are characterised by a space-saving axial height. Moreover these bearings have a high rigidity and load-carrying capacity. As a standard, Cylindrical Roller Thrust Bearings are acting uni-directionally and are offered in single row and double row design.

Cylindrical Roller Thrust Bearings have a shaft washer, a housing washer, and an axial roller cage with cylindrical rollers. These parts can also be supplied separately. This is useful in cases where the raceways are integrated in the shaft and/or the housing and therefore the shaft washer and/or housing washer can be dispensed with.

General Technical Bearing Information

Dimensions

The main dimensions of Cylindrical Roller Thrust Bearings are in compliance with DIN 722 (in case of the single row design - series 811 and 812) and DIN 616 and ISO 104 (in case of the double row design - series 893 and 894).

Operation Temperature

Cylindrical Roller Thrust Bearings are suitable for operating temperatures from -30°C to +150°C.

Restricted by the cage made from synthetic material Cylindrical Roller Thrust Bearings with the suffix TV are suitable for operating temperatures from -30°C to +120°C.

Heat Treatment Process

Rings and rollers are fully hardened by standard.

Limiting Rotational Speed

The limiting rotational speed value shown in the data sheets applies to oil lubrication. In case of grease lubrication the limiting rotational speed equals to 25 % of this value.



Cylindrical Roller Thrust Bearings

Misalignment

Cylindrical Roller Thrust Bearings cannot tolerate any misalignments between shaft and housing or any angular deviations between the support surfaces on the shaft and in the housing.

Tolerances

By default Cylindrical Roller Thrust Bearings are produced to tolerance class PN according to DIN 620-2 and ISO 199 respectively. On request the bearing parts can be produced to tolerance class P5 as well.

The tolerances of the bearing parts are listed in the table below:

		tolerances					
		bore		outer diameter		height	
axial roller cage	K	d	E11 ^{*1}	D	a13 ^{*1}	D _W	DIN 5402-1
shaft washer	WS	d	DIN 620-3	d ₁	-	B	h11
housing washer	GS	D ₁	-	D	DIN 620-3	B	h11

^{*1} deviation of the average diameter

Equivalent Bearing Load

dynamic: $P = F_a$
static: $P_0 = F_a$



Cylindrical Roller Thrust Bearings

Minimum Axial Load

Cylindrical Roller Thrust Bearings need a minimum axial load in order to ensure a failure-free operation, particularly if the bearings are to operate at high rotational speeds or are subjected to high accelerations.

The minimum axial load can be calculated with sufficient accuracy on basis of the following equation:

$$F_{a \min} = 0,0005 * C_{0a} + k_a * \left(\frac{C_{0a} * n}{10^3} \right)^2$$

Explanation:

$F_{a \min}$	minimum axial Load [N]
C_{0a}	static axial load rating [N]
n	operating rotational speed [r/min]
k_a	factor dependant on the bearing series
	series 811 1,4
	series 812 0,9
	series 893 0,7
	series 894 0,5

In cases where the calculated minimum axial load cannot be reached the bearings have to be preloaded by either inserting an appropriate spring or a shaft nut.

Design of Associated Components

The bearing washers should be fully supported as possible across the overall raceway. The abutting shoulders are rigid and the support surfaces must be at right angles to the shaft axis.

Cylindrical roller and cage thrust assemblies are generally guided radially on the shaft especially at high rotational speeds. The guiding areas must be provided with a fine ground and wear resistant surface.

In cases where the Cylindrical Roller Thrust Bearings are used without shaft washers or/and housing washers the contact area must be of appropriate bearing component surface and hardness quality. Moreover, appropriate roller bearing steel has to be used. Please contact us for further information.



Cylindrical Roller Thrust Bearings

The following table shows the tolerances for the shafts and housing bores.

		tolerances	
		shaft	housing bore
axial roller cages	K	h8	-
shaft washers	WS	h8	-
housing washers	GS	-	H9

Suffixes

This list shows suffixes for deliverable designs:

M solid brass cage, roller guided *1

P5 dimension and running tolerance less than P6 *2

TV polyamide 6.6 cage, roller guided *1

*1 cage design is dependant on bearings series and size

*2 on request



Baureihe / Series
811

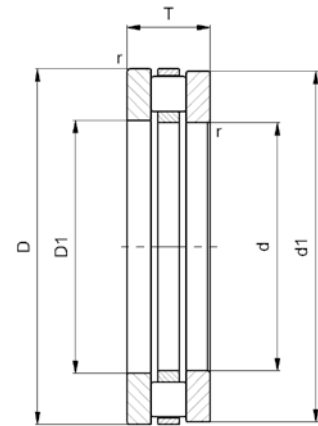
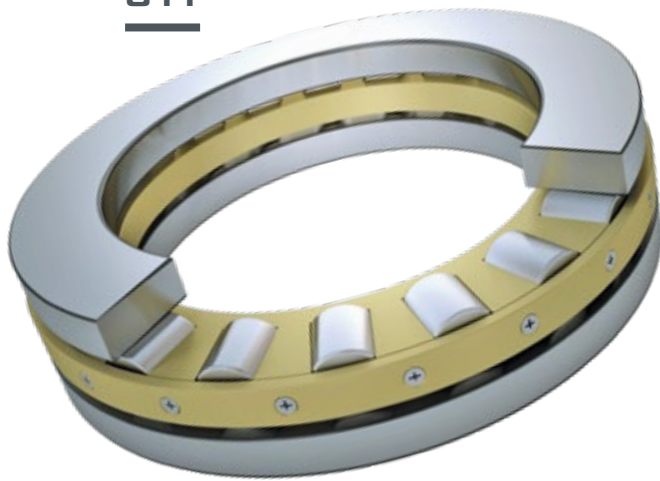

811

Bezeichnung description	Gewicht weight [kg]	Kurzzzeichen Lagerteile abbreviation bearing parts			Abmessungen measures [mm]				
		Axial-Rollenkranz axial roller and cage assembly	Gehäusescheibe housing washer	Wellenscheibe shaft washer	d	D	d ₁	D ₁	T
81120.TV	0,95	K 81120.TV	GS 81120	WS 81120	100	135	135	102	25
81122.TV	1,05	K 81122.TV	GS 81122	WS 81122	110	145	145	112	25
81124.TV	1,1	K 81124.TV	GS 81124	WS 81124	120	155	155	122	25
81126.TV	1,7	K 81126.TV	GS 81126	WS 81126	130	170	170	132	30
81128.TV	1,9	K 81128.TV	GS 81128	WS 81128	140	180	178	142	31
81130.TV	2	K 81130.TV	GS 81130	WS 81130	150	190	188	152	31
81132.TV	2,2	K 81132.TV	GS 81132	WS 81132	160	200	198	162	31
81134.M	2,7	K 81134.M	GS 81134	WS 81134	170	215	213	172	34
81136.M	3,2	K 81136.M	GS 81136	WS 81136	180	225	222	183	34
81138.M	4,3	K 81138.M	GS 81138	WS 81138	190	240	237	193	37
81140.M	4,5	K 81140.M	GS 81140	WS 81140	200	250	247	203	37
81144.M	4,9	K 81144.M	GS 81144	WS 81144	220	270	267	223	37
81148.M	7,9	K 81148.M	GS 81148	WS 81148	240	300	297	243	45
81152.M	8,5	K 81152.M	GS 81152	WS 81152	260	320	317	263	45
81156.M	11,6	K 81156.M	GS 81156	WS 81156	280	350	347	283	53
81160.M	18	K 81160.M	GS 81160	WS 81160	300	380	376	304	62
81164.M	19,7	K 81164.M	GS 81164	WS 81164	320	400	396	324	63
81168.M	20,4	K 81168.M	GS 81168	WS 81168	340	420	416	344	64
81172.M	21,5	K 81172.M	GS 81172	WS 81172	360	440	436	364	65
81176.M	22,5	K 81176.M	GS 81176	WS 81176	380	460	456	384	65
81180.M	24	K 81180.M	GS 81180	WS 81180	400	480	476	404	65
81184.M	25	K 81184.M	GS 81184	WS 81184	420	500	495	424	65
81188.M	40	K 81188.M	GS 81188	WS 81188	440	540	535	444	80
81192.M	43	K 81192.M	GS 81192	WS 81192	460	560	555	464	80
81196.M	44,5	K 81196.M	GS 81196	WS 81196	480	580	575	484	80



Baureihe / Series
811

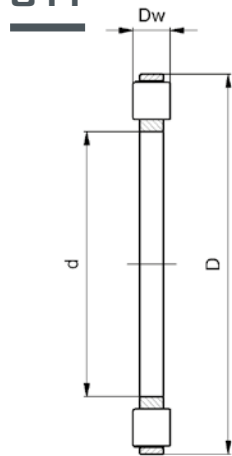

K 811

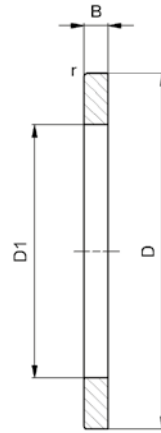

GS 811

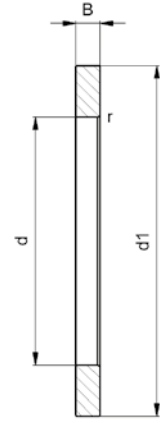

WS 811

Abmessungen measures [mm]			Tragzahlen load ratings		Ermüdungsgrenzbelastung fatigue limit load	Grenzdrehzahl limiting speed	Bezeichnung description
B	D _w	r _{min}	dyn. C _a [kN]	stat. C _{0a} [kN]	C _{ua} [kN]	n _G [min ⁻¹]	
7	11	1	148	580	60	2400	81120.TV
7	11	1	154	630	63	2200	81122.TV
7	11	1	160	680	65	2200	81124.TV
9	12	1	190	815	78	1900	81126.TV
9,5	12	1	197	870	80	1800	81128.TV
9,5	12	1	204	930	83	1700	81130.TV
9,5	12	1	211	990	86	1700	81132.TV
10	14	1,1	265	1220	111	1600	81134.M
10	14	1,1	275	1300	112	1500	81136.M
11	15	1,1	315	1500	129	1400	81138.M
11	15	1,1	325	1590	133	1400	81140.M
11	15	1,1	340	1730	139	1300	81144.M
13,5	18	1,5	470	2370	191	1100	81148.M
13,5	18	1,5	490	2560	200	1100	81152.M
15,5	22	1,5	675	3460	275	950	81156.M
18,5	25	2	850	4380	340	850	81160.M
19	25	2	875	4630	350	800	81164.M
19,5	25	2	900	4890	360	800	81168.M
20	25	2	910	5020	365	750	81172.M
20	25	2	935	5280	375	750	81176.M
20	25	2	960	5530	385	700	81180.M
20	25	2	980	5790	395	700	81184.M
24	32	2,1	1420	8030	570	600	81188.M
24	32	2,1	1470	8450	585	600	81192.M
24	32	2,1	1480	8660	590	560	81196.M



Baureihe / Series
812

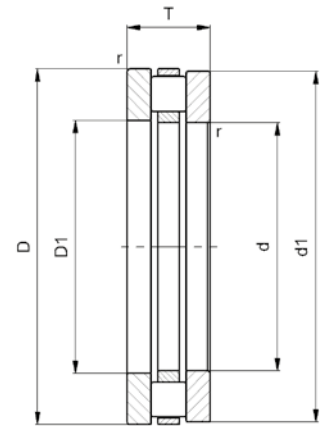
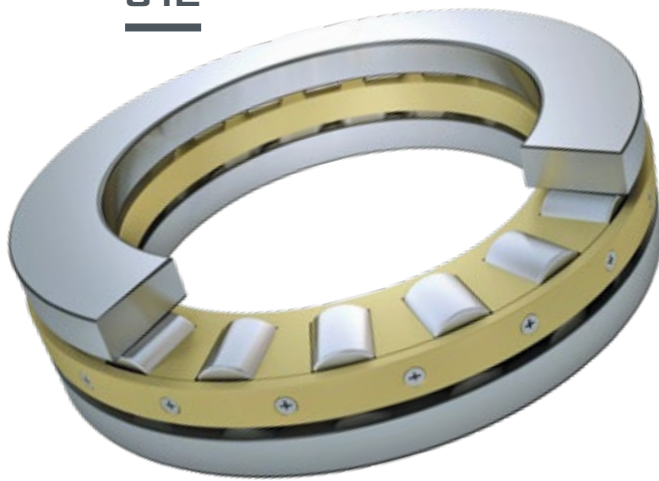

812

Bezeichnung description	Gewicht weight [kg]	Kurzzzeichen Lagerteile abbreviation bearing parts			Abmessungen measures [mm]				
		Axial-Rollenkranz axial roller and cage assembly	Gehäusescheibe housing washer	Wellenscheibe shaft washer	d	D	d ₁	D ₁	T
81218.M	1,8	K 81218.M	GS 81218	WS 81218	90	135	135	93	35
81220.M	2,3	K 81220.M	GS 81220	WS 81220	100	150	150	103	38
81222.M	2,4	K 81222.M	GS 81222	WS 81222	110	160	160	113	38
81224.M	2,7	K 81224.M	GS 81224	WS 81224	120	170	170	123	39
81226.M	4,3	K 81226.M	GS 81226	WS 81226	130	190	187	133	45
81228.M	4,8	K 81228.M	GS 81228	WS 81228	140	200	197	143	46
81230.M	6,6	K 81230.M	GS 81230	WS 81230	150	215	212	153	50
81232.M	7	K 81232.M	GS 81232	WS 81232	160	225	222	163	51
81234.M	8,5	K 81234.M	GS 81234	WS 81234	170	240	237	173	55
81236.M	9,1	K 81236.M	GS 81236	WS 81236	180	250	247	183	56
81238.M	11,7	K 81238.M	GS 81238	WS 81238	190	270	267	194	62
81240.M	13,1	K 81240.M	GS 81240	WS 81240	200	280	277	204	62
81244.M	14,2	K 81244.M	GS 81244	WS 81244	220	300	297	224	63
81248.M	24,5	K 81248.M	GS 81248	WS 81248	240	340	335	244	78
81252.M	26,5	K 81252.M	GS 81252	WS 81252	260	360	355	264	79
81256.M	29	K 81256.M	GS 81256	WS 81256	280	380	375	284	80
81260.M	43	K 81260.M	GS 81260	WS 81260	300	420	415	304	95
81264.M	45	K 81264.M	GS 81264	WS 81264	320	440	435	325	95
81268.M	48,5	K 81268.M	GS 81268	WS 81268	340	460	455	345	96
81272.M	68,5	K 81272.M	GS 81272	WS 81272	360	500	495	365	110
81276.M	74	K 81276.M	GS 81276	WS 81276	380	520	515	385	112
81280.M	77	K 81280.M	GS 81280	WS 81280	400	540	535	405	112
81284.M	104	K 81284.M	GS 81284	WS 81284	420	580	575	425	130
81288.M	114	K 81288.M	GS 81288	WS 81288	440	600	595	445	130
81292.M	119	K 81292.M	GS 81292	WS 81292	460	620	615	465	130
81296.M	134	K 81296.M	GS 81296	WS 81296	480	650	645	485	135



Baureihe / Series
812

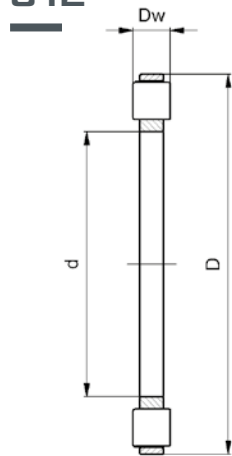

K 812

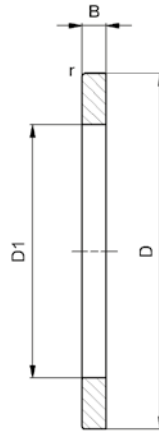

GS 812

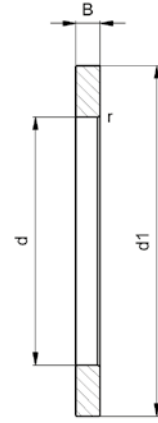

WS 812

Abmessungen measures [mm]			Tragzahlen load ratings		Ermüdungsgrenzbelastung fatigue limit load	Grenzdrehzahl limiting speed	Bezeichnung description
B	D _w	r _{min}	dyn. C _a [kN]	stat. C _{0a} [kN]	C _{ua} [kN]	n _G [min ⁻¹]	
10,5	14	1,1	220	790	83	2000	81218.M
11,5	15	1,1	255	960	98	1800	81220.M
11,5	15	1,1	250	960	96	1700	81222.M
12	15	1,1	255	1010	98	1600	81224.M
13	19	1,5	365	1400	136	1400	81226.M
13,5	19	1,5	375	1470	138	1400	81228.M
14,5	21	1,5	450	1800	167	1300	81230.M
15	21	1,5	465	1890	172	1200	81232.M
16,5	22	1,5	525	2180	194	1100	81234.M
17	22	1,5	535	2280	198	1100	81236.M
18	26	2	700	2930	260	1000	81238.M
18	26	2	720	3070	265	1000	81240.M
18,5	26	2	755	3350	280	950	81244.M
23	32	2,1	1060	4650	390	800	81248.M
23,5	32	2,1	1080	4860	400	750	81252.M
24	32	2,1	1140	5280	420	750	81256.M
28,5	38	3	1500	6850	530	630	81260.M
28,5	38	3	1560	7440	560	600	81264.M
29	38	3	1600	7740	570	600	81268.M
32,5	45	4	2090	9980	700	530	81272.M
33,5	45	4	2140	10400	735	530	81276.M
33,5	45	4	2200	11000	760	500	81280.M
39	52	5	2780	13600	925	430	81284.M
39	52	5	2810	14000	935	430	81288.M
39	52	5	2870	14600	955	430	81292.M
39,5	56	5	3230	16300	1080	400	81296.M



Baureihe / Series
893

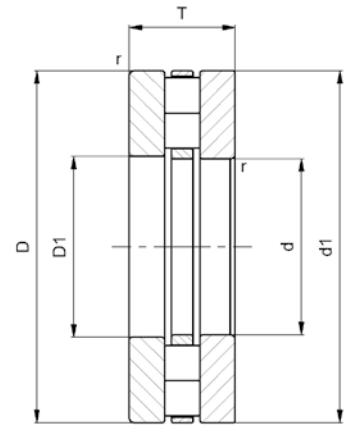
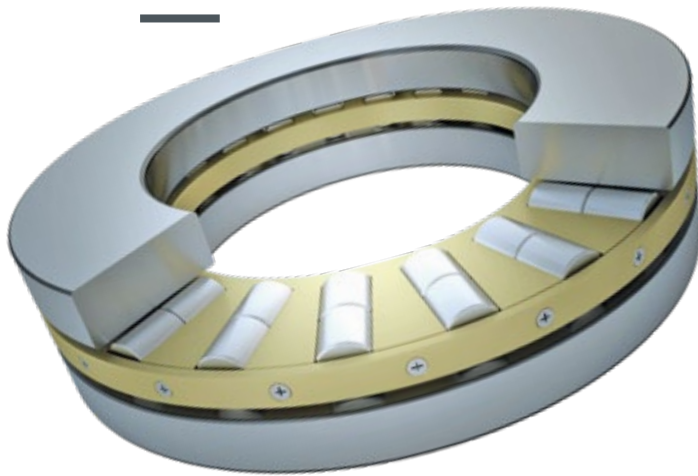

893

Bezeichnung description	Gewicht weight [kg]	Kurzzzeichen Lagerteile abbreviation bearing parts			Abmessungen measures [mm]				
		Axial-Rollenkranz axial roller and cage assembly	Gehäusescheibe housing washer	Wellenscheibe shaft washer	d	D	d ₁	D ₁	T
89317.M	3,2	K 89317.M	GS 89317	WS 89317	85	150	150	88	39
89318.M	3,5	K 89318.M	GS 89318	WS 89318	90	155	155	93	39
89320.M	4,5	K 89320.M	GS 89320	WS 89320	100	170	170	103	42
89322.M	6,6	K 89322.M	GS 89322	WS 89322	110	190	190	113	48
89324.M	9,2	K 89324.M	GS 89324	WS 89324	120	210	210	123	54
89326.M	10,8	K 89326.M	GS 89326	WS 89326	130	225	225	134	58
89328.M	12,6	K 89328.M	GS 89328	WS 89328	140	240	240	144	60
89330.M	13,2	K 89330.M	GS 89330	WS 89330	150	250	250	154	60
89332.M	17,5	K 89332.M	GS 89332	WS 89332	160	270	270	164	67
89334.M	18,6	K 89334.M	GS 89334	WS 89334	170	280	280	174	67
89336.M	23,2	K 89336.M	GS 89336	WS 89336	180	300	300	184	73



Baureihe / Series
893

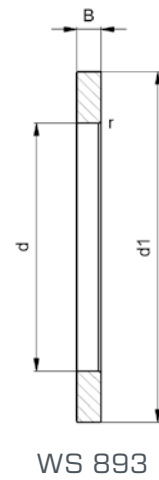
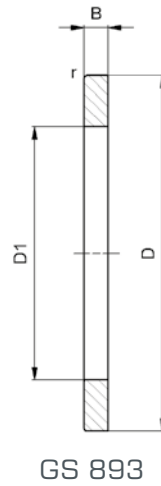
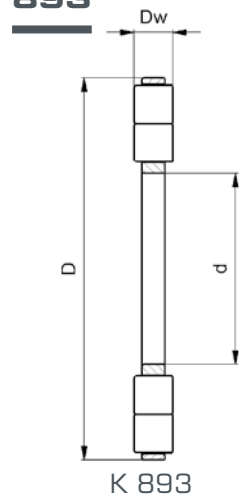

Abmessungen measures [mm]			Tragzahlen load ratings		Ermüdungsgrenzbelastung fatigue limit load	Grenzdrehzahl limiting speed	Bezeichnung description
B	D _w	r _{min}	dyn. C _a [kN]	stat. C _{0a} [kN]	C _{ua} [kN]	n _G [min ⁻¹]	
13,5	12	1,5	255	1100	107	2200	89317.M
13,5	12	1,5	265	1160	110	2000	89318.M
14,5	13	1,5	305	1350	126	1900	89320.M
16,5	15	2	400	1820	167	1700	89322.M
18,5	17	2,1	490	2220	204	1500	89324.M
20	18	2,1	565	2630	235	1400	89326.M
20,5	19	2,1	625	2950	260	1300	89328.M
20,5	19	2,1	640	3100	270	1300	89330.M
23	21	3	800	3940	335	1200	89332.M
23	21	3	820	4120	340	1100	89334.M
24,5	24	3	1010	4970	420	1100	89336.M



Baureihe / Series
894

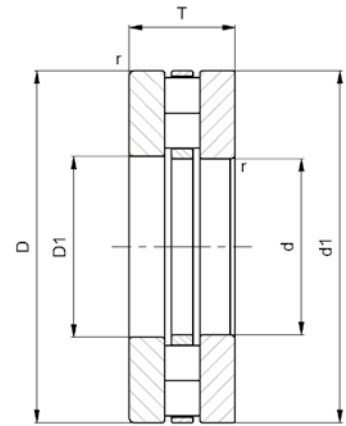
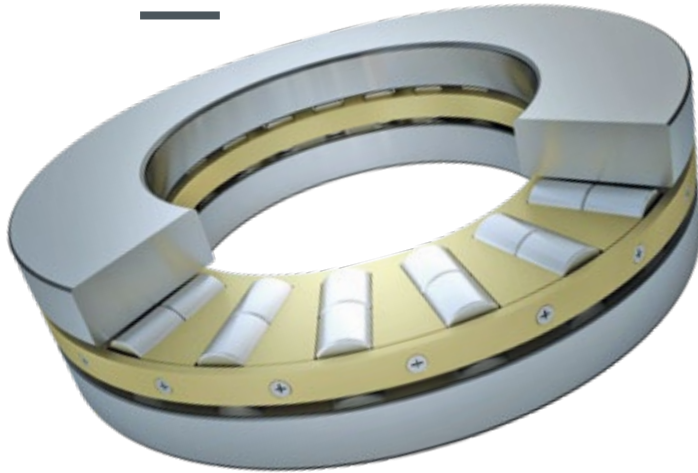

894

Bezeichnung description	Gewicht weight [kg]	Kurzzzeichen Lagerteile abbreviation bearing parts			Abmessungen measures [mm]				
		Axial-Rollenkranz axial roller and cage assembly	Gehäusescheibe housing washer	Wellenscheibe shaft washer	d	D	d ₁	D ₁	T
89416.M	7,7	K 89416.M	GS 89416	WS 89416	80	170	170	83	54
89417.M	8,2	K 89417.M	GS 89417	WS 89417	85	180	180	88	58
89418.M	9,5	K 89418.M	GS 89418	WS 89418	90	190	190	93	60
89420.M	12,7	K 89420.M	GS 89420	WS 89420	100	210	210	103	67
89422.M	16,5	K 89422.M	GS 89422	WS 89422	110	230	230	113	73
89424.M	20,7	K 89424.M	GS 89424	WS 89424	120	250	250	123	78
89426.M	25,5	K 89426.M	GS 89426	WS 89426	130	270	270	134	85
89428.M	28,5	K 89428.M	GS 89428	WS 89428	140	280	280	144	85
89430.M	34	K 89430.M	GS 89430	WS 89430	150	300	300	154	90
89432.M	40	K 89432.M	GS 89432	WS 89432	160	320	320	164	95
89434.M	49,5	K 89434.M	GS 89434	WS 89434	170	340	340	174	103
89436.M	57,5	K 89436.M	GS 89436	WS 89436	180	360	360	184	109
89438.M	69	K 89438.M	GS 89438	WS 89438	190	380	380	195	115
89440.M	79	K 89440.M	GS 89440	WS 89440	200	400	400	205	122
89444.M	86	K 89444.M	GS 89444	WS 89444	220	420	420	225	122
89448.M	92	K 89448.M	GS 89448	WS 89448	240	440	440	245	122
89452.M	120	K 89452.M	GS 89452	WS 89452	260	480	480	265	132
89456.M	151	K 89456.M	GS 89456	WS 89456	280	520	520	285	145
89460.M	162	K 89460.M	GS 89460	WS 89460	300	540	540	305	145
89464.M	200	K 89464.M	GS 89464	WS 89464	320	580	580	325	155



Baureihe / Series
894

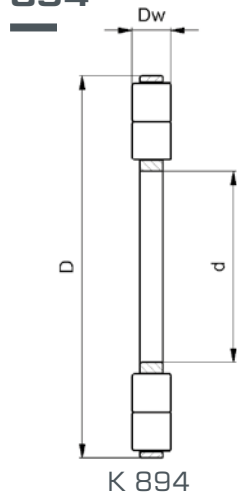

K 894

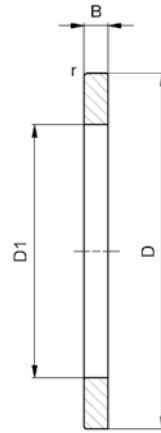

GS 894

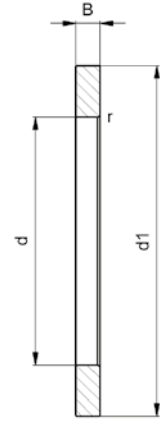

WS 894

Abmessungen measures [mm]			Tragzahlen load ratings		Ermüdungsgrenzbelastung fatigue limit load	Grenzdrehzahl limiting speed	Bezeichnung description
B	D _w	r _{min}	dyn. C _a [kN]	stat. C _{0a} [kN]	C _{ua} [kN]	n _G [min ⁻¹]	
18	18	2,1	440	1710	170	1800	89416.M
19	20	2,1	515	1960	198	1700	89417.M
20	20	2,1	540	2130	208	1600	89418.M
22,5	22	3	640	2570	250	1400	89420.M
24,5	24	3	800	3300	305	1300	89422.M
26	26	4	930	3900	355	1200	89424.M
28,5	28	4	1060	4500	405	1100	89426.M
28,5	28	4	1100	4800	420	1100	89428.M
30	30	4	1260	5500	480	1000	89430.M
31,5	32	5	1420	6300	545	950	89432.M
34,5	34	5	1590	7200	610	850	89434.M
36,5	36	5	1760	8000	670	800	89436.M
38,5	38	5	1950	8900	750	750	89438.M
41	40	5	2150	9900	820	700	89440.M
41	40	6	2330	11200	890	700	89444.M
41	40	6	2400	11900	920	670	89448.M
44	44	6	2850	14300	1090	630	89452.M
48,5	48	6	3370	17100	1290	560	89456.M
48,5	48	6	3470	18000	1330	530	89460.M
51,5	52	6	3830	19800	1470	500	89464.M

The IDC logo consists of the lowercase letters 'idc' in a bold, sans-serif font, followed by a small square icon containing a stylized 'd'.

Axial-Zylinderrollenlager

Cylindrical Roller Thrust Bearings

INTERPRECISE Donath GmbH
Ostring 2
90587 Obermichelbach
Germany

Telefon +49-911-76630-0
Telefax +49-911-76630-30

info@interprecise.de
www.idc-bearings.com