



Avaya 3725 DECT Telephone

User Guide

03/2010
Issue 1.0

© 2010 Avaya Inc.
All Rights Reserved.

Notice

While reasonable efforts were made to ensure that the information in this document was complete and accurate at the time of printing, Avaya Inc. can assume no liability for any errors. Changes and corrections to the information in this document may be incorporated in future releases.

For full legal page information, please see the complete document, Avaya Legal Page for Hardware Documentation, Document number 03-600759.

To locate this document on our Web site, simply go to <http://www.avaya.com/support> and search for the document number in the search box.

Documentation disclaimer

Avaya Inc. is not responsible for any modifications, additions, or deletions to the original published version of this documentation unless such modifications, additions, or deletions were performed by Avaya. Customer and/or End User agree to indemnify and hold harmless Avaya, Avaya's agents, servants and employees against all claims, lawsuits, demands and judgments arising out of, or in connection with, subsequent modifications, additions or deletions to this documentation to the extent made by the Customer or End User.

Link disclaimer

Avaya Inc. is not responsible for the contents or reliability of any linked Web sites referenced elsewhere within this documentation, and Avaya does not necessarily endorse the products, services, or information described or offered within them. We cannot guarantee that these links will work all of the time and we have no control over the availability of the linked pages.

Warranty

Avaya Inc. provides a limited warranty on this product. Refer to your sales agreement to establish the terms of the limited warranty. In addition, Avaya's standard warranty language, as well as information regarding support for this product, while under warranty, is available through the following Web site:

<http://www.avaya.com/support>

Copyright

Except where expressly stated otherwise, the Product is protected by copyright and other laws respecting proprietary rights. Unauthorized reproduction, transfer, and or use can be a criminal, as well as a civil, offense under the applicable law.

Avaya support

Avaya provides a telephone number for you to use to report problems or to ask questions about your product. The support telephone number is 1-800-242-2121 in the United States. For additional support telephone numbers, see the Avaya Web site:

<http://www.avaya.com/support>

Software License

USE OR INSTALLATION OF THE PRODUCT INDICATES THE END USER'S ACCEPTANCE OF THE TERMS SET FORTH HEREIN AND THE GENERAL LICENSE TERMS AVAILABLE ON THE AVAYA WEBSITE AT <http://support.avaya.com/LicenseInfo/> ("GENERAL LICENSE TERMS"). IF YOU DO NOT WISH TO BE BOUND BY THESE TERMS, YOU MUST RETURN THE PRODUCT(S) TO THE POINT OF PURCHASE WITHIN TEN (10) DAYS OF DELIVERY FOR A REFUND OR CREDIT.

Avaya grants End User a license within the scope of the license types described below. The applicable number of licenses and units of capacity for which the license is granted will be one (1), unless a different number of licenses or units of capacity is specified in the Documentation or other materials available to End User. "Designated Processor" means a single stand-alone computing device. "Server" means a Designated Processor that hosts a software application to be accessed by multiple users. "Software" means the computer programs in object code, originally licensed by Avaya and ultimately utilized by End User, whether as stand-alone Products or pre-installed on Hardware. "Hardware" means the standard hardware Products, originally sold by Avaya and ultimately utilized by End User.

License Type(s):

Designated System(s) License (DS). End User may install and use each copy of the Software on only one Designated Processor, unless a different number of Designated Processors is indicated in the Documentation or other materials available to End User. Avaya may require the Designated Processor(s) to be identified by type, serial number, feature key, location or other specific designation, or to be provided by End User to Avaya through electronic means established by Avaya specifically for this purpose.

Third-party Components

Certain software programs or portions thereof included in the Product may contain software distributed under third party agreements ("Third Party Components"), which may contain terms that expand or limit rights to use certain portions of the Product ("Third Party Terms"). Information identifying Third Party Components and the Third Party Terms that apply to them is available on Avaya's Web site at:

<http://support.avaya.com/ThirdPartyLicense/>

Interference

Using a cell, mobile, or GSM telephone, or a two-way radio in close proximity to an Avaya IP Telephone might cause interference.

Security

See <http://support.avaya.com/security> to locate and/or report known vulnerabilities in Avaya products. See <http://support.avaya.com> to locate the latest software patches and upgrades. For information about secure configuration of equipment and mitigation of toll fraud threats, see the Avaya Toll Fraud and Security Handbook at <http://support.avaya.com>.

Contents

Important Safety Information	9
Sensitive Electronic Environment (EU/EFTA only)	9
Regulatory Compliance Statements (EU/EFTA only)	10
Always dispose of old equipment correctly - keep our environment tidy (EU/EFTA only)	11
Regulatory Compliance Statements (USA and Canada only).	11
Frequency Range	13
Power Supply	13
Safety Precautions.	13
Usage	14
Bluetooth Qualified Design ID	14
Environmental Requirements.	15
Introduction	17
Functions and Accessories	18
Functions.	18
Accessories	18
Descriptions	20
The Avaya 3725 DECT Telephone	21
Chargers	22
Desktop Charger.	22
Charging the telephone in Desktop charger	22
Rackmount Charger	23
Multiple Battery Charger	23
Icons and Text in the Display	23
Keys and Buttons	28
Off-hook Key	28
On-hook, and On/Off Key	28
Navigation/Confirmation Key	28
Voice mail Key	28
Sound off Key	28
Key Lock, and Upper/Lower Case Key	29
Soft keys	29
Hot keys	29
Multifunction Button.	29
Volume Button	29
Sound off button	30
Alphanumeric Keys	30
Accessories	31
Belt Clips	31
Telephone lanyard	31
Leather Casing.	31

Contents

Headset	32
Menu Tree	33
Calls	33
Contacts	35
Profiles	36
Messaging	37
My favourites	38
Short cuts	38
Connections	39
Settings	40
In Call	41
Customizing the Menu Tree.	42
Basic Operation	43
Switch the Telephone On/Off	43
Turn the Audible Signal On/Off	43
Lock/Unlock the Keypad	43
Lock/Unlock the Telephone	44
Calling	45
Incoming Call	45
Answer a Call.	45
Decline a Call.	45
End a Call.	45
Outgoing Call	45
Dial a Number (Pre-Dial).	45
Dial a Number directly (Post-Dial)	46
Dial Using a Pre-programmed Hot key, Soft key or Multifunction button	46
Dial a Number from the Call list.	46
Dial the sender of a Message	46
Dial a Number from the Local Phonebook	47
Dial a Name from the Central Phonebook	47
During a Call	47
Adjust the Volume during a Call	47
Open Contacts during the Call	48
Turn the Microphone on/off during a Call	48
Audio Transfer	48
Start a New Call during Conversation	48
Switch between Calls	49
End a Call.	49
Transfer a Call	49
Transfer to new Call	49

Starting a Conference Call	50
Call Back	50
Call Waiting.	50
DTMF	50
Loudspeaking Function	51
Call Diversion	51
General Purpose	51
Messaging	52
Message List	52
Receive a Message	52
Send a Message	52
Write and Send a Message	53
Voice Mail	53
Receive a Voice Mail.	53
Check the Voice Mail inbox	53
One Key Voice Mail Access	53
Menu Operation	54
Connections	54
Bluetooth	54
Headset.	54
System	55
In Charger	56
Calls	57
Call List.	57
Missed Calls	58
Call Time	59
Call Services	59
Short Cuts	60
Define Soft Keys	61
Define Hot Keys	61
Define Navigation Key	61
Define Multi-function Button	62
My favourites.	62
Add favourites	62
Delete favourites.	63
Messaging	63
Inbox	63
Write New Messages.	65
Unsent Messages	65
Sent Messages.	65

Contents

Profiles	66
Contacts	67
Call Contact	68
Add Contact	68
Edit Contact	69
Delete Contact	69
Central Phonebook	69
Settings.	70
Sound and Alert Settings	70
Phone Lock settings.	71
Display Settings	72
Time & Date Settings	73
Answering	73
Change Text size for Messages.	74
Change the Menu Language	74
Change Owner ID	74
Device info	75
Advanced Functions.	76
Admin Menu	76
Clear Lists in Charger	76
System Handling.	77
Software Upgrade	77
Troubleshooting	78
Operation Notice.	80
Accessibility and Voice Quality.	80
Maintenance	81
Charge the Battery.	81
Charge Spare Batteries	81
Replace the Battery	81
Attach the Hinge-type Clip	82
Attach the Swivel-type Clip	83
Attach Cover for No Clip	83
Bluetooth Headset.	85
Introduction	85
Wear	85
Headsets	86
Operation.	86
Enable Bluetooth.	86
Pair and Connect a Bluetooth Headset.	87
Add another Bluetooth Headset	87

Select a Bluetooth Headset	87
Remove a Headset	88
Change the name of Bluetooth headset.	88
Calling	88
Make a Call	88
Answer a Call.	88
End a Call.	89
Volume/Mute Control	89
Adjust the Volume During a Call	89
Turn the Microphone On/Off During a Call.	89
Messaging	89
Transfer a call	89
Transfer a Call to the Telephone	89
Transfer a Call to the Bluetooth Headset.	89
Switch to a Headset with Cord	90
Menu Tree	90
Operation Notice.	90
Accessibility and Voice quality	90
Operation Area.	90
Out of Range	90
Environmental Requirements.	91
Bluetooth Headset Battery	91
Troubleshooting	91
Quick Reference Guide	93
Index	103

Contents

Important Safety Information

Read this chapter before using the Avaya 3720 DECT Telephone or Avaya 3725 DECT Telephone.

For safe and efficient operation of the telephone, observe the guidelines given in this manual and all necessary safety precautions when using the telephone. Follow the operating instructions and adhere to all warnings and safety precautions located on the product, the Quick Reference Guide and this User Manual.

This product shall only be used with the following batteries:

Avaya 3725 DECT Telephone:

No. 700466691: DECT 3725 HANDS. BATTERY PACK

Avaya 3720 DECT Telephone:

No. 700466683: DECT 3720 HANDS. BATTERY PACK

Chargers shall only be connected with power adapters included in the following charger kits:

Basic Charger:

No. 700466253: DECT HS. BASIC CHARGER KIT EU

No. 700466261: DECT HANDSET BASIC CHARGER KIT UK/NAR/AU

Advanced Charger:

No. 700466279: DECT HS. ADV CHARGER KIT EU

No. 700466287: DECT HS. ADV CHARGER KIT UK

No. 700466295: DECT HS. ADV CHARGER KIT NAR

No. 700466303: DECT HS. ADV CHARGER KIT AU

Sensitive Electronic Environment (EU/EFTA only)

Only use this product in countries where the appropriate authorities have given their authorisation.

The CE symbol on the product certifies its conformity with the technical guidelines concerning user safety and electro-magnetic compatibility valid at the time of approval; in accordance with European directive No. 1999/05/EC.



The product Avaya 3725 DECT Telephone complies with IP44; the product Avaya 3720 DECT Telephone complies with IP42 - both according to IEC 529 / EN 60 529.

Any radio-based equipment can potentially cause interference with other equipment and can be interfered from other equipment. This also applies for DECT equipment. However due to the very low transmission power level the changes for interference are very small. Research proves that operational DECT phones normally don't influence electronic equipment however some precautions must be taken into account for sensitive electronic equipment e.g. sensitive laboratory equipment. When DECT phones operate in straight nearness of sensitive electronic equipment incidental influence can appear. You are advised not to place the DECT phone on or close (less then 10 cm) to this kind of equipment, even in standby mode.

Regulatory Compliance Statements (EU/EFTA only)

Permission and Conformity

We, Avaya GmbH & Co. KG, declare that the product line DECT R4 concurs with the basic requirements and other relevant provisions of EU Directive 1999/5/EU concerning radio equipment and telecommunications terminal equipment and the mutual recognition of their conformity.

Intended use

This equipment is intended for connection to radio interfaces (DECT) of Avaya PABX systems.

It is compliant with the essential requirements of the EU-Directive 1999/5/EU (Radio and Telecommunication Terminal Equipment, R&TTE).

Due to the differences of the individual public networks and network operators this compliance does not by itself give an unconditional assurance of successful operation at every network termination point. For the time being we are not aware of any network on which the equipment will not work due to its design.

In the event of problems, you should contact your equipment supplier or your Avaya service.

The conformity declaration can be accessed at the following Internet address:

www.avaya.de/gcm/emea/de/includedcontent/conformity.htm

or search the index using the key term "Conformity".

Always dispose of old equipment correctly - keep our environment tidy (EU/EFTA only)



Old electrical and electronic equipment marked with this symbol can contain substances hazardous to human beings and the environment. Never dispose of these items together with unsorted municipal waste (household waste). In order to protect the environment, public collection points have been set up to ensure the correct disposal of old electrical and electronic equipment marked with this symbol.

To reduce the risk of these substances being released into the environment and to reduce the burden on natural resources, it is also possible to participate in Avaya's used equipment return system. This system ensures the correct recycling of old equipment as well as the re-utilisation of individual components.

Regulatory Compliance Statements (USA and Canada only)

Portables without Bluetooth	Portables with Bluetooth
FCC ID:BXZDH4	FCC ID:BXZDH4BL
IC: 3724B-DH4	IC: 3724B-DH4BL
US: 9FVW4NANDH4	US: 9FVW4NANDH4

FCC compliance statements

This equipment has been tested and found to comply with the limits for a Class B digital device, pursuant to part 15 of the FCC Rules. These limits are designed to provide reasonable protection against harmful interference in a residential installation. This equipment generates, uses and can radiate radio frequency energy and, if not installed and used in accordance with the instructions, may cause harmful interference to radio communications. However, there is no guarantee that interference will not occur in a particular installation. If this equipment does cause harmful interference to radio or television reception, which can be determined by turning the equipment off and on, the user is encouraged to try to correct the interference by one or more of the following measures:

- Reorient or relocate the receiving antenna.
- Increase the separation between the equipment and receiver.
- Connect the equipment into an outlet on a circuit different from that to which the receiver is connected.
- Consult the dealer or an experienced radio/TV technician for help.

Privacy of communications may not be ensured when using this cordless telephone.

Use of non-manufacture approved accessories may violate the FCC RF exposure guidelines and should be avoided.

Exposure to Radio Frequency Signals

This equipment complies with FCC radiation exposure limits set forth for an uncontrolled environment. This device complies with FCC SAR limit of 1.6 W/kg. The maximum SAR value measured when used at the ear, and when worn on the body using belt clip:

SAR values	With Bluetooth	Without Bluetooth
Head	0.104 W/Kg	0.072 W/Kg
Body worn	0.029 W/Kg	0.036 W/Kg

This device and its antenna must not be co-located or operating in conjunction with any other antenna or transmitter.

Information to User

This device complies with Part 15 of the FCC Rules. Operation is subject to the following two conditions:

- (1) this device may not cause harmful interference, and
- (2) this device must accept any interference received, including interference that may cause undesired operation.

Modifications

Changes or modifications to the equipment not expressly approved by the party responsible for compliance could void the user's authority to operate the equipment.

IC Requirements for Canada

This Class B digital apparatus complies with Canadian ICES-003.
Cet appareil numérique de la Classe B conforme à la norme NMB-003 du Canada.

Frequency Range

The telephone is a radio transmitter and receiver. When it is on, it receives and sends out radio frequency (RF) energy. The telephone operates on different frequency ranges depending on market and employs commonly used modulation techniques:

EU	1880-1900 MHz
USA	1920-1930 MHz
LA	1910-1930 MHz
BR	1910-1920 MHz

Power Supply

The mains voltage of the adapter should match the local mains voltage, this can be 110 V or 230 V. Check if both voltages do match before installing the charger and adapter.

Safety Precautions

- Do not open the cordless telephone or charger, this could expose you to high voltages. Have all repairs carried out by authorized service personnel.
- Do not allow the charger and the battery contacts to come into contact with conductive objects such as keys, paper clips, rings or bracelets.
- Do not allow the cordless telephone and charger to come into contact with water or chemicals.
- Only use the plug-in AC adapter and battery type supplied.
- Do not use AC adapters which are visibly damaged (cracked or broken housing) and keep the ventilation slits on the plug-in AC adapters free.
- Do not use the cordless telephones in vehicles or in hazardous locations.
- This product contains magnetic material. Be aware that small metallic objects may stick for example to the loudspeaker. This may deteriorate the audio quality and can be harmful.
- **Save this manual.** It includes important safety information and operating instructions. Save all instructions for future reference.
- Position the electrical cord to the AC power supply where it is least likely to be subjected to damage or stress.

- Remove the electrical cord from an outlet by pulling gently on the AC adapter, not by pulling the cord.
- Remove the battery before cleaning the telephone to reduce risk of electric shock.
- Unplug the battery charger from a power source before cleaning the telephone to reduce risk of electric shock.
- Do not use auxiliary equipment with the telephone which is not exclusively recommended by the manufacturer, see [Accessories](#) on page 18. The use of any auxiliary equipment not recommended by the manufacturer may result in fire, electric shock, or injury, and will void the warranty.
- Do not expose the telephone to open flame.
- Do not expose the telephone and the charger to direct sunlight for long periods. Keep the telephone and charger away from excessive heat and moisture.
- Do not allow heavy objects to fall on the telephone.
- Do not allow children to play with the product packaging material. Product packaging material is often small and may present a choking hazard.
- Do not allow children to play with the telephone. It is not a toy. Children could hurt themselves or others. Children could also damage the telephone.
- Do not expose to prolong light

Usage

Like all other cordless telephones, this cordless telephone uses radio signals which do not guarantee a connection set-up under all circumstances. Generally, you should therefore not rely exclusively on cordless telephones when making indispensable calls (e.g. medical emergencies).

Bluetooth Qualified Design ID

Bluetooth QD ID: B014317

Environmental Requirements

Cordless Telephone

- Only use the telephone in temperatures between 0 °C to +40 °C (32 °F to 104 °F).
- Avoid exposing the telephone for direct sunlight or close to other heat sources.
- Do not expose the telephone to open flame.
- Keep the telephone away from excessive heat and moisture.
- Avoid sudden temperature changes to prevent condensation in the telephone. It is recommended to put the telephone into an air tight plastic bag until the temperature is adjusted, for example, when entering or leaving a cold/heated building on a warm/cold day.
- Protect your telephone from aggressive liquids and vapours.
- If the telephone has been exposed for water or condense, remove the battery immediately and let it dry completely before re-inserting the battery.
- Keep the telephone away from strong electromagnetic fields.
- Do not place a cold telephone in a charger.

Battery

- Do not immerse the battery into water. This could short-circuit and damage the battery.
- Do not expose a battery to an open flame. This could cause the battery to explode.
- Do not allow the metal contacts on the battery to touch another metal object. This could short-circuit and damage the battery.
- Do not leave a battery where it could be subjected to extremely high temperatures, such as inside a car on a hot day.
- Use the Desktop Charger or the wall mounted Charging Rack for charging. Charge the battery for at least one hour the first time you use the battery. Note that the wall mounted charger with a battery pack adapter has to be used if the battery alone is to be charged.
- Do not charge a battery when the ambient room temperature is above 40 °C or below +5 °C (above 104 °F or below 41 °F).
- Do not attempt to take a battery apart.
- Do power the telephone off before removing the battery.

Chemical Resistance

The alpha and numeric characters printed on the exterior of the telephone have been tested and found resistant to chipping, fading or wearing off when the telephone is treated with common cleaners and disinfectants or perspiration. The following chemicals have shown no harmful effect:

- 3% Hydrochloric Acid
- M-alcohol (70% Methylated Ethanol)
- 60% Chlorhexidin 0.5 mg/ml

Acetone can be damaging to the plastic casing of the telephone and should not be used.

Introduction

This document describes features and settings available for the Avaya 3725 DECT Telephone. The cordless telephone is a feature-rich telephone with colour display, telephony, messaging, and bluetooth as optional. It is designed to be used in medium demanding environment such as hospital environment, but also office environment.

It is suitable for users dependent of being reachable and/or having a need for mobile voice and messaging features, which makes it ideal for applications where the user needs either one way messaging or to be able to interact with other users. The colour display enhances and simplifies the use of the cordless telephone.

Read the [Important Safety Information](#) on page 9 before using the telephone.

For software download and parameter set up, read the *Installation and Administration Manual, DECT R4*.

Quick Reference Guide

To get a quick overview on the basic functions of your telephone, see [Quick Reference Guide](#) on page 93. Because of its handy format you can place a print-out next to your telephone as a quick reference.

Functions and Accessories

Functions

- Local phonebook (250 contacts)
- Central phonebook
- Company phonebook
- Vibrator
- Headset connector
- Microphone on/off during call
- Loudspeaking function
- SMS (Short message service)
- Voice mail access
- Centralized Management
- Easy replaceable battery
- Bluetooth

Note:

Use of the functions Central phonebook, SMS (Short message service), Voice mail access and Centralized Management are system depending.

Accessories

- Basic Charger
- Advanced Charger
- Rackmount Charger
- Multiple Battery Charger
- Battery Pack
- Leather case
- Belt Clip
 - hinge-type
 - swivel-type
- Telephone lanyard
- Headset with microphone on boom

- Headset with microphone on cable
- Bluetooth headset

Descriptions

Figure 1: Description of the cordless telephone.



- | | |
|--|---|
| <p>1. Top/Multifunction button
This button can be used as a short cut to functions; long or double press modes</p> <p>2. Earpiece speaker</p> <p>3. Volume up
To increase the speaker volume</p> <p>4. Volume down
To decrease the speaker volume</p> <p>5. Sound off button
To turn on/off audible signals in idle mode, silencing the ring signal at incoming call and to mute in call.</p> <p>6. Soft keys
The 3 Soft keys can be pre-programmed or used with GUI</p> | <p>10. Microphone</p> <p>11. Space
To add space between text</p> <p>12. Sound off key
To turn on/off audible signals in idle mode, silencing the ring signal at incoming call and to mute in call.</p> <p>13. Five-way navigation key
Navigation key with Left, Right, Up, Down. The middle Centre select key is a select key. It is also possible to program these keys for short cuts, except the middle key.</p> <p>14. On-hook; On/Off key
Combined button; to end a call, to return to idle mode, and to switch the telephone on/off by long press.</p> <p>15. Colour display
The full graphic type display is 128 pixels wide and 160 pixels high. The display has multiple colours and backlighting.</p> |
|--|---|

- | | |
|---|---|
| <p>7. Off-hook key
To answer a call, to pre-dial a number, and to post-dial</p> <p>8. Voice mail access
A quick access to the telephone's Voice mail</p> <p>9. Key lock and Upper/Lower case
Combined key lock and Upper/Lower Case</p> | <p>16. Headset connector
The headset connector is for connecting a headset. The connector is protected against dust by using the headset connector cover.</p> <p>17. LED
Indicates incoming call, messaging, low battery, and charging.</p> |
|---|---|

The Avaya 3725 DECT Telephone



Important:

The telephone may retain small magnetic objects around the microphone or speaker region.

Case

The plastic cover parts are made of durable PC/ABS material.

Antenna

The antenna is integrated inside the cordless telephone.

Loudspeaker

The cordless telephone has a separate loudspeaker for the loudspeaking function. It is placed on the back side of the cordless telephone.

Microphone

The microphone is placed on the front bottom side of the cordless telephone.

Clip

There are three different belt clip options to the cordless telephone; a hinge-type clip (standard), a swivel-type clip, or no clip which makes it possible to use the cordless telephone without any clip on. See [Attach the Hinge-type Clip](#) on page 82, or [Attach the Swivel-type Clip](#) on page 83. Use the clip to attach the telephone to a belt or similar.

Battery

The battery is a rechargeable Li-Pol battery, placed under a battery cover. See [Replace the Battery](#) on page 81.

The battery is fully charged within four hours. See [Charge the Battery](#) on page 81.

The battery can be charged separately with a special Multiple Battery Charger. See [Charge Spare Batteries](#) on page 81

Chargers

Desktop Charger

Figure 2: Desktop chargers

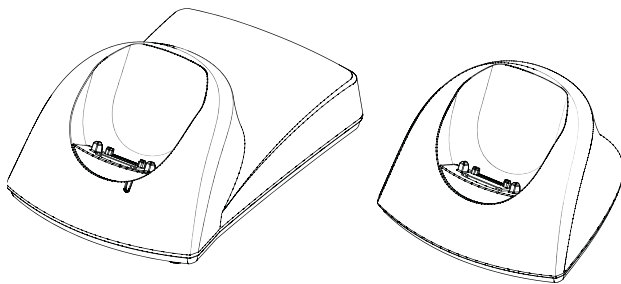

Advanced

Basic

There are two desktop chargers available, one Basic charger that will only charge the cordless telephone, and one Advanced Charger with advanced functionality to download new software and synchronize parameters. The cordless telephone is fully operational while placed in the charger.

The Basic Charger is delivered with a plug-in power supply and is connected into an ordinary wall socket. The Advanced Charger is delivered with a power supply adapter. The adapter is connected with a power cord to the wall socket and the Charger itself is supplied from the adapter.

For more information, see *Installation and Administration Manual, DECT R4*.

Note:

Only use the charger within the temperature range of +5° C – +40° C.



Important:

Only use the provided power supply, see *Installation and Administration Manual, DECT R4*.

Charging the telephone in Desktop charger

When the charger is connected to external power supply, normal operation is done as follows:

Telephone charging

1. Place a cordless telephone in the charging slot to start charging.

Telephone disconnection

1. First, tilt the telephone forwards.
2. Then, lift the telephone upwards.

Note:

Do not try to lift the telephone upwards before tilting it forwards.

Rackmount Charger

The Rackmount Charger is used for charging several telephones, to synchronize parameters, and for software download.

The built in power supply can charge up to six cordless telephones.

See *Installation and Administration Manual, DECT R4*.

Multiple Battery Charger

The Multiple Battery Charger is used for charging up to six spare batteries.

Icons and Text in the Display

All functions and settings available to the user are shown as icons and text in the display. The icons and text in the display indicate functions and settings to which you have access. The display normally displays date and time, the Owner ID and telephone number. The Owner ID can manually be set by the user.

Figure 3: Example of a display configuration in idle mode

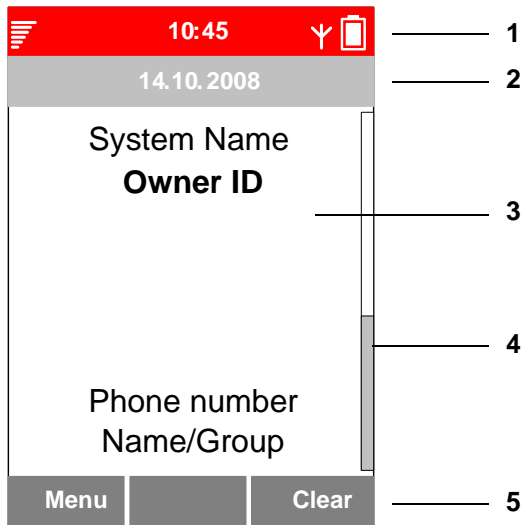

Figure notes:

- | | |
|----------------|-----------------|
| 1. Status bar | 4. Scroll bar |
| 2. Header bar | 5. Soft key bar |
| 3. Active area | |

The top row (**Status bar**) is used for icons which give the user information for signal strength, missed call, new message, phone lock, key lock, sound off, time and battery status. This row is always visible in all screens.

The next row (**Header bar**) displays the current date, headset connection, Bluetooth connection, and system connection.

The next rows (**Active area**) are used for information such as, profiles, the name of the system to which the cordless telephone is connected to. A user identity provided from the system and/or an Owner ID can also be displayed if configured in the Settings menu. This is also the area for pop up text for example, missed calls or to confirm an action.

The bottom row (**Soft key bar**) is used for Soft keys which can be used as short cuts for functions in the telephone. See [Soft keys](#) on page 29.

The (**Scroll bar**) is placed to the right side of the active area. It becomes visible when a menu screen has more than six menus, or if there are more than four rows of message text in a message.

Icons



Signal strength icon is visible in the upper left corner. The staples shown in display depends on the signal strength.



Full battery icon is displayed in upper right corner.



Low battery icon is shown when the battery only has 5% of its capacity left. The icon is flashing when the battery capacity is equal to, or lower, than 5%.



Sound off icon is displayed when the Sound off key is pressed.



Ring volume silent icon is displayed when the volume is set to silent.



Microphone off icon indicates a silenced microphone. It is displayed after a long press on the Sound off key during a call.



Loudspeaking icon is displayed in the Soft key bar during a call. Pressing this icon will activate the loudspeaking mode.



Loudspeaking off icon is displayed after the Soft key for Loudspeaking icon has been pressed. Pressing this icon will deactivate the loudspeaking mode.



New message icon indicates that a new text message (or messages) has arrived. The icon remains in the status bar until all new messages in the inbox are read.



Voice mail message icon is displayed in the inbox when there are voice mails. The icon remains until voice mail has been listened.



Read message icon in front of a message shows that this message once has been read.



Sent message icon



Unsent message icon



Key lock icon indicates a locked keypad.



Phone lock icon indicates a locked telephone.



Bluetooth icon indicates that Bluetooth is enabled.



Bluetooth headset icon indicates that a Bluetooth headset is connected to the telephone.



Headset icon indicates that a corded headset is connected to the telephone.



Outgoing call icon is added to all outgoing calls in the call list.



Incoming call icon is added to all answered calls in the call list.



Missed call icon is added to all missed calls in the call list, and in the status bar.



System connection icon is visible when connected to an administration system.



Profile active icon

Menu icons



The **Contacts** menu contains all names/numbers in the personal phonebook. It is also possible to access a central phonebook from this menu.



The **My favourites** menu contains menu short cuts used to customize an own menu.



The **Messaging** menu contains all message handling such as reading and writing messages.



The **Calls** menu contains call lists, call time, and call services¹. Call services is configured in the PDM or AIWS.



The **Connections** menu contains Bluetooth connection, headset selection, System selection, and In charger selection.



The **Settings** menu contains personal telephone settings such as changing the ringer volume, selecting language, etc.



The **Short cuts** menu contains short cuts for the Soft keys, Hot keys, Navigation keys, and the Multifunction button.



The **Profiles** menu contains possibility to add four different profiles. By default there is no profile.

1. System dependent

Keys and Buttons

Off-hook Key



This key is used for connecting calls. This key can be programmed in the PDM/AIWS, it is by default set as Post-dial.

On-hook, and On/Off Key



This key is used for disconnecting calls and returning to main screen.

A long press in idle mode will switch the telephone on/off.

Navigation/Confirmation Key



Use this key to step in the menu and when working in text mode.

◀, ▶, ▲, and ▼ are used for stepping left/right and up/down in the menu. The navigation key can be programmed, the ▲ is by default a short cut to the Inbox, and ▼ is a short cut to Call contact. During a call it is possible to increase/decrease the volume by pressing ▲ and ▼.

The middle key is for confirmation and in idle mode it is by default a short cut to the main menu.

Voice mail Key



A long press on this key gives a quick access to the telephone's Voice mail.

Sound off Key

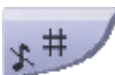

This key is to silence or mute the telephone. It works like the [Sound off button](#) on page 30.

Key Lock, and Upper/Lower Case Key



This key is to lock or unlock the keypad in combination with the Soft key **Lock**. It is also for switching between upper/lower case and digits.

Soft keys

Figure 4: Soft keys.

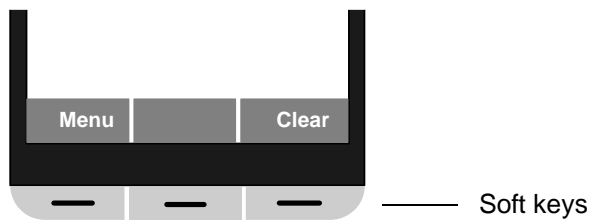

The three Soft keys are located just beneath the display and the functions of each Soft key is indicated by text in the display just above the keys.

In idle mode the Soft keys can be used for specific functions defined by the user of the telephone.

Hot keys

A Hot key can be programmed to give access to frequently used functions such as dialling a specific telephone number, a short cut on the menu, or sending an SMS. Any key **0, 2 - 9** can be set to a Hot Key. A long press on any of these digits in stand by mode are by default a short cut to the Call contact list.

Multifunction Button

The button is placed on the top side of the cordless telephone. This button can be used as a short cut to functions; long or double press modes. It is by default not used, but can be defined by the user of the telephone.

Volume Button

The two buttons placed on the upper left side of the cordless telephone are used for increasing/decreasing the earpiece, headset, and the loudspeaker volume.

Sound off button

The button is placed on the left side of the cordless telephone, next to the screen.

- While in a call a press on the button will mute the microphone.
- When the telephone is ringing a short press switches off the ringing tone temporarily.
- In idle mode a long press will silence the telephone.

Alphanumeric Keys

Key	Capital letter	Small letter
1	. , ? ! - ' " 1	. , ? ! - ' " 1
2	A B C À Â Æ Ç 2	a b c æ à â æ ç 2
3	D E F È É Ê Ë 3	d e f è é ê ë 3
4	G H I Î Ï 4	g h i î ï 4
5	J K L 5	j k l 5
6	M N O Ñ Ô Ö Ø 6	m n o ñ ô ö ø 6
7	P Q R S 7	p q r s 7
8	T U V Û 8	t u v û 8
9	W X Y Z 9	w x y z 9
0	Space + * 0	Space + * 0
*	*	*
#	#	#

Note:

Depending on the selected menu language, other characters can be available. This means that the character order can differ from the table above.

In idle mode, and number input mode

- A short press on a key enter the digits 0 - 9 and the characters * and #.
- Enter a pause in number input mode by a long press on the #-key. A pause is indicated by a **P** in the display.
- A long press on the *- key changes the tone sender on. Tone sender on is indicated by a **T** in the display.

In text input mode

- A short press on a key **0 - 9**, displays the first available character on that specific key. The marked character is selected after a timeout, or when another key is pressed.
- To change to upper/lower case, press the *****-key before entering the character. The *****-key can also be used to display only the digits.
- To add space in the text, make a short press on key **0**.
- The first character entered in a message, or when adding/editing a name in the Contacts menu, will be an upper level character followed by lower level characters, unless the *****-key is pressed before entering the character. To switch between **Abc**, **ABC**, **abc**, and **123** the *****-key is pressed.
- A long press on the key **#** displays special characters.
- To delete a character, position the prompt right from the character to delete and press Soft key **Clear**.

Accessories

Belt Clips

Three belt clip options are available:

- Hinge-type clip
To prevent the telephone from slipping out of for example pocket or belt
- Swivel-type clip
To be able to rotate without slipping out from the case
- No clip
To be able to use the telephone without a clip

Telephone lanyard

The Telephone lanyard is attached directly to an eyelet on top of the telephone. It is 800 mm long and can be worn around the neck.

Leather Casing

The leather casing is especially designed for the telephone. The casing comes with a swivel type belt clip and the telephone is fully operational while placed in the casing.

Headset

A headset is recommended if you frequently use the telephone and/or want to have both hands free. The headset comes in two versions; microphone integrated in the cable, and microphone on a boom.

Menu Tree

Note:

In order to continuously improve the comprehensibility of menu terms, some of them in your telephone may differ from those used in the following menu trees.

Calls

Call list	>	7891 01:30 7845 20-Oct-08 ...	>	● Call	
				● More	> Time of call
					Edit number
					Save number
					Send message
					Delete
					Delete all
				● Back	
Missed calls	>	7682 05:26 7845 23-Sep-08	>	● Call	
				● More	> Time of call
					Edit number
					Save number
					Send message
					Delete
					Delete all
				● Back	

Call time	>	Total time 03:47:06 Last call 00:00:07			
Call services	>	Absence ¹	>	Deactivate	
				Lunch	
				Meeting	
				Trip	
				Vacation	
				Out	
				Absence 1 - Absence 4	
		Divert calls ¹	>	Internal	
				External	
				No reply	
				When busy	
		General purpose 1 Name ¹ - General purpose 10 Name ¹			

1. Visible if defined in PDM or AIWS

Contacts

Call contact	>	Search			
		<From contact list>			
Add contact	>	New	>	Name	
				Work number	
				Mobile number	
				Other number	
				Ring signal	
		From call list			
Edit contact	>	Search		Back	
		<From contact list>		Name	
				Work number	>
				Mobile number	
				Other number	
				Ring signal	
Delete contact	>	Search			
		<From contact list>			
Central phonebook ¹	>	Search by name	>	● Call	
		Search by number	>	● More	> View contact
		Last result	>		Add to contacts
					Send message
				● Back	

1. System dependent

Profiles

Normal (example)	>	<Name>			
		Volume			
		Ring signals	>	Internal call	> <Ring signal>
				External call	> <Ring signal>
				Call back	> <Ring signal>
		Message alert	>	<Ring signal>	
		Vibrating alert	>	On	
				Off	
				On if silent	
		Key sound	>	Click	
				Tone	
				Silent	
		Answer behaviour	>	Automatically	
				Loudspeaking	
Add new					

Messaging

Inbox	>	Message List	>	● View	>	● Reply	>	Enter text
						● More	>	Delete
								Forward
								Call sender
								Call no. in text
								Save number
						● Close		
				● More	>	Delete		
						Delete all		
				● Back				
Write new message	>	Enter Text						
Unsent	>	Message List	>	● Edit	>	● Send	>	Enter number
						● Clear		
						● Back		
				● More	>	Delete		
						Delete all		
				● Back				
Sent	>	Message List	>	● View	>	● Forward	>	Enter text
						● More	>	Delete
								Call no. in text
								Save number
						● Close		
				● More	>	Delete		
						Delete all		
				● Back				

My favourites



Add new	>	Name	>	Phone call		
				Send message		
<Name>		● Select				
		● More		Edit		
				Delete		
		● Back				

Short cuts



Soft keys	>	Left	>	Name		
				Function	>	Not used
						Phone call
						Contact list
						Central phonebook
						Message inbox
						Send message
						Change profile
						Open a menu
						Call absence
				Value		
				Control question		
		Middle				
		Right				
Hot keys	>	0, 2 - 9	>	Function	>	(same as above)
				Value		

				Control question	
Navigation keys	>	Up	>	Function	> (same as above)
		Down		Value	
		Left		Control question	
		Right			
Multifunction button	>	Long press	>	Function	> (same as above)
		Multi press		Value	
				Control question	

Connections

Bluetooth	>	Enable / Disable			
		Headset	>	Add new	
Headset	>	Mic on boom			
		Mic on cable			
		Hearing protection			
		<headset profile>			
System	>	Change system			
		Subscribe			
		Unsubscribe			
		Rename system			
		Priority			
In charger	>	No action			
		Switch off			
		Redirect			

Settings

Sounds & Alerts	>	Volume			
		Ring signals			
		Message alert			
		Vibrator alert			
		Key sound			
Locks	>	Automatic key lock	>	On	
				Off	
		Phone lock	>	Auto phone lock	> On
					On in charger
					Off
				Change PIN code	
Display	>	Brightness	>	Normal	
				Screen saver	
		Screen saver	>	Information	
				Black	
Time & Date	>	Time format			
		Date format			
Answering	>	Answering key	>	Hook-off	
				Any key	
		Answering behaviour	>	Automatically	
				Loudspeaking	
Messages	>	Text size			
*Language	>	Dansk, Nederlands, English, ...			
Owner ID					
Device info	>	Software			

	Hardware			
	IPEI			
	User ID			

In Call

The In Call menu can be reached during an ongoing call by pressing the middle Soft Key marked **More**.

Contacts ²				
Microphone on/off				
Audio transfer ¹				
New call ²	>	Call		
		"Phonebook access"		
		Cancel		
Switch ²				
End call ²				
Transfer ²				
Transfer to new call ²	>	Call		
		"Phonebook access"		
		Cancel		
Conference ²				
Call back ²				
Call waiting ²				
DTMF				
General purpose 1 Name ² - General purpose 10 Name ²				

1. Only available when Bluetooth connection is active

2. Visible if defined in the PDM or AIWS

Customizing the Menu Tree

The menu tree can be customized by hiding some of the functions that are available but for example not in use. Which functions that should be hidden are defined in the PDM or AIWS. See *Installation and Administration Manual, DECT R4*.

Basic Operation

Switch the Telephone On/Off

The telephone is switched off:

1. Press and hold **On-hook** key.
The telephone will vibrate when it is on and the display lights up.

The telephone is in idle mode:

1. Press **On-hook** key long.
A control question will be displayed.
2. Confirm with Soft key **Yes**.

Note:

The telephone returns to idle mode when pressing the **On-hook** key while in a menu.

Turn the Audible Signal On/Off

Your telephone is in idle mode or rings.

1. Press the **Sound off** button long. The status of the telephone changes between ring signal on/off. To locate the button, see [Descriptions](#) on page 20.

The  icon indicates a silenced telephone.

Lock/Unlock the Keypad

To prevent accidentally pressing keys and making a call, the keys can be locked.

Lock keypad

1. Press * key.
2. Press Soft key **Lock**.

Unlock keypad

1. Press * key.
2. Press Soft key **Yes**.

Note:

It is possible to answer/close an incoming call while the keypad is locked.

Note:

You can activate an automatic key lock. Then the keypad will automatically locked a short time after the last keystroke. See [Activate the Automatic Key Lock](#) on page 71.

Note:

While placed in charger a telephone's keypad is always unlocked.

Lock/Unlock the Telephone

The telephone can be protected for unauthorized use. If this function is activated it locks automatically a short time after the last keystroke or when placed in the charger. A PIN code is required for unlocking the telephone. For more information see [Phone Lock settings](#) on page 71.

Unlocking the telephone

The phone shows the text "Turn off phone lock?"

1. Press Soft key **Yes**.
2. Enter PIN code
3. Press Soft key **OK**.

Calling

Incoming Call

The flashing LED, accompanied by a ring signal and/or a vibrating telephone, give you notice of a call. Ring signal and vibrator can be disabled. The calling party's telephone number or name is shown. The name will be shown if the calling party's telephone number is stored in the local phonebook. Press the Off-hook key to answer the call. When a headset is connected to the telephone, the answering button on the headset can be used to answer the call.

Other answering methods can also be set in the Settings menu, see [Settings](#) on page 40. The answering methods are **Automatically** and **Loudspeaking**.

Answer a Call

Your telephone rings.

1. Press **Off-hook** key or press the Soft key  to answer the call in loudspeaking mode.

Decline a Call

Your telephone rings.

1. Press **On-hook** key to decline the call.

Note:

A priority call cannot be declined.

End a Call

1. Press **On-hook** key to end the call.
The duration of the call is shown in the display.

Note:

The total time of the call can also be retrieved from the menu **Calls > Call time**.

Outgoing Call

Dial a Number (Pre-Dial)

1. Enter the number.

2. If needed, you can press the Soft key **Clear** to erase the last entered digit. By using the navigation key ◀▶ it is possible to step and add/delete a digit in the middle of a number.
3. Press **Off-hook** key to get the line. The number is shown on the display while dialling.

Note:

It is possible to turn on/off the tone sender in a post-dialled number by making a long press on the *-key.

Dial a Number directly (Post-Dial)

1. Press **Off-hook** key to get the line.
2. Enter the number. Each entered digit is dialled immediately. However, in this case you will not be able to correct an input error.

Note:

The number will not be added to the call list when pre-dial is used.

Dial Using a Pre-programmed Hot key, Soft key or Multifunction button

A Hot key, Soft key or Multifunction button can be programmed with a telephone number. Press the pre-programmed Hot key, Soft key or multifunction button to dial the number. The call will automatically be connected.

Dial a Number from the Call list

1. Open the menu by pressing the confirmation button, or the Soft key **Menu**.
2. Select **Calls**.
3. Select **Call list**,
4. Step with the ▲ and ▼ to scroll in the list. Select number to call.
5. Press Soft key **Call** to dial.

Dial the sender of a Message

You can call the sender of a message stored in the message list, from the Messaging menu.

1. Open the menu by pressing the confirmation button, or the Soft key **Menu**.
2. Select **Messaging**.
3. Select **Inbox**.
4. Select number from the list.
5. Select **View**.
6. Select **More**.

7. Select **Call sender**.

Dial a Number from the Local Phonebook

1. Open the menu by pressing the confirmation button, or the Soft key **Menu**.
2. Select **Contacts**.
3. Select **Call contact**.
4. Select contact from list, or search name by entering characters.
The best matching entry will be automatically selected.
5. Press Soft key **Call** or the **Off-hook** key to make the call.

Dial a Name from the Central Phonebook

1. Open the menu by pressing the confirmation button, or the Soft key **Menu**.
2. Select **Contacts**.
3. Select **Central phonebook**.
4. Select **Search by name**.
5. Enter the first name and/or last name, the whole name does not have to be entered.
6. Press **Search**.
7. Press Soft key **Call** or **Off-hook** key to make the call.

During a Call

Note:

Some of these functions are system dependent and are not shown in the menu. They are set up by your system administrator in the PDM or AIWS, see *Installation and Administration Manual, DECT R4*.
If applicable additional functions could be programmed by your system administrator.

Adjust the Volume during a Call

1. Press the **Volume up** button to increase the volume, and the **Volume down** button to decrease the volume.
The telephone will now store and keep the new volume level.

Note:

It is also possible to use the navigation key, ▲ and ▼ to adjust the volume.

Open Contacts during the Call

1. Press Soft key **More**.
2. Select **Contacts**.
3. Press Soft key **Select**.
4. See [Contacts](#) on page 67.

Turn the Microphone on/off during a Call

1. Press the Soft key **More**.
2. Select **Microphone off**.
3. Press Soft key **Select**.

The  indicate a silenced microphone. This means that the other part in an ongoing call cannot hear you.

Turn the microphone back on:

1. Press Soft key **More**.
2. Select **Microphone on**.
3. Press **Select**.

Note:

It also possible to turn the microphone off/on by a long press on the **Sound off** button, see [Descriptions](#) on page 20.

Audio Transfer

To transfer audio between the Bluetooth headset and the telephone's earpiece during the call.

1. Press Soft key **More**.
2. Select **Audio transfer**.
3. Press Soft key **Select**.

Note:

Audio transfer is visible if Bluetooth connection is active.

Start a New Call during Conversation

1. Press **Off-hook** key.
The first caller is put on hold.
2. Dial the number.

Note:

You can also start a new call via Soft key **More > New Call**. Dial the number and press Soft key **Call**.

Switch between Calls

A new call is started during conversation, the first call is on hold.

1. Press Soft key **R**.

This will switch between the calls.

Note:

You can also switch between the call via Soft key **More > Switch**.

End a Call

A new call is started during conversation, the first call is on hold.

1. Press the **On-Hook** key.

This will end the current call. The held call rings again as priority call.

Note:

You can also end the call via Soft key **More > End Call**.

Transfer a Call

A new call is started during conversation, the first call is on hold.

1. Press Soft key **More**.
2. Select **Transfer**.
3. Press Soft key **Select**.

This will connect the first caller with the person you want to transfer the call to.

Transfer to new Call

1. Press Soft key **More** during the call.
2. Select **Transfer to new call**.
3. Press Soft key **Select**.
4. Dial the number to the person you want to transfer the call to.
5. Press **Off-hook** key to transfer the call.

Starting a Conference Call

A new call is started during conversation, the first call is on hold.

1. Press Soft key **More**.
2. Select **Conference call**.
3. Press Soft key **Select**.

The person initiating the conference call is the conference leader, and the other are participant members of the conference call.

Call Back

To enable call back when a call is made to a busy telephone, and to be alerted when the telephone is free.

1. Press Soft key **More**.
2. Select **Call back**.
3. Press Soft key **Select**.
4. Press **On-hook** key.
5. Wait until the telephone alerts.
6. When the telephone alerts, press **Off-hook** key.
The call will automatically be started.

Call Waiting

During a call. A second call appears and the a short tone could be heard.

1. Press Soft key **More**.
2. Select **Call waiting**.
3. Press Soft key **Select**.
You are connected with the new caller. The other part is put on hold.

When the line is free it will automatically call the hold part again. This is system dependent.

Note:

You can also accept the second call by pressing the **Off-Hook** key.

DTMF

During a call.

1. Press Soft key **More**.
2. Select **DTMF**.

3. Press **Select**.

This will enable the use of Dual Tone Multi Frequency (DTMF) signals.

Loudspeaking Function

During a call the loudspeaking function can be activated.

1. Press left Soft key.

To turn loudspeaking function off again:

1. Press left Soft key again.

Call Diversion

All calls, internal calls, external calls, calls when busy, or calls at no answer can be diverted to another telephone number. The diversion is made via the **Calls menu > Call services > Divert calls**. See [Call Services](#) on page 59.

It is also possible to programme a Soft key, Hot key, or Multifunction button with a short cut to the **Call diversion** function. Refer to [Short Cuts](#) on page 60, and [Divert Internal/External Calls](#) on page 59.

General Purpose

Besides the default Call services functions, it is possible to define 10 extra system specific codes. This is programmed in the PDM or AIWS. See also [Call Services](#) on page 59.

Messaging

For getting information on all Messaging functions see [Messaging](#) on page 63.

Message List

The thirty last received messages are stored in a list. The message list is located in the Messaging menu **Inbox**. Time and date information is included in the message.

Receive a Message

When a text message is received, the LED starts flashing and the message alert signal sounds. The **New message** icon, and a text with information of received message are displayed. The icon will remain in the display until all new messages are opened. If the message is received during a call a beep notifies the user.

1. Press Soft key **Yes** to read the message or to read the message later press Soft key **No**.

The message will in both cases be stored in the Inbox.

It is possible to reply, forward the message, call the sender, and call number in text, irrespective of reading the message directly or later from the inbox, see [Inbox](#) on page 63.

Note:

Messages sent from a message server (AIWS) are shown as **Network** messages. You cannot reply to this sender.

Send a Message

- For text input keys 0-9, * or # can be used.
- Key 0 and 1 contains special characters, see [Alphanumeric Keys](#) on page 30 to see all characters.
- The maximum message length is 160 characters.

Note:

Some characters require 2 bytes in the final message, therefore the user will sometimes not be able to enter 160 characters.

- For basic rules of text input, see [Alphanumeric Keys](#) on page 30.

Write and Send a Message

1. Enter **Messaging** menu.
2. Select **Write new message**.
3. Enter the message text.
4. Press Soft key **Send**.
5. Enter the call number
6. Press Soft key **Send** to send the message.

Voice Mail

Receive a Voice Mail

A new voice mail is indicated by icon **New message** in the status bar. Information is stored in the **Messaging** inbox, see [Messaging](#) on page 37.

Check the Voice Mail inbox

1. Enter **Messaging** menu, see [Messaging](#) on page 37.
2. Select **Inbox**.
The voice mail will be displayed first in the inbox list.
3. Select icon **Voice Mail**.
4. Press Soft key **View**, and then **Call**.

Only one voice mail at the time will be displayed, even if there are more voice mail messages in the message list.

One Key Voice Mail Access

To enable one key Voice Mail Access, your mailbox extension number has to be downloaded to the telephone, see *Installation and Administration Manual, DECT R4*.

Your telephone is in Idle mode.

1. Press long on digit key **1**.
Your voice mail will be called. If the extension number is not available a pop-up **Voice mail number not defined** is displayed.
2. Follow the given instruction in the Voice Mail.

Menu Operation

Figure 5: The main menu.

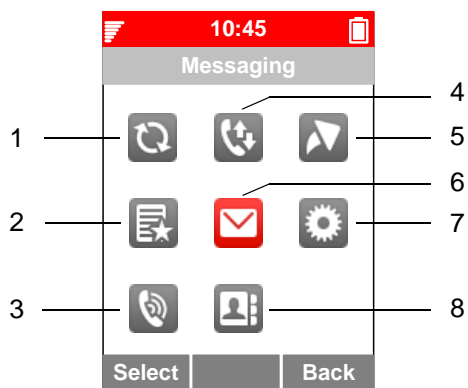

Figure notes:

- | | |
|------------------|---------------|
| 1. Connections | 5. Short cuts |
| 2. My favourites | 6. Messaging |
| 3. Profiles | 7. Settings |
| 4. Calls | 8. Contacts |

Connections

1. Enter the menu by pressing the **Menu** Soft key, or the confirmation button on the Navigation key.
2. Select **Connections** icon.
3. Press the confirmation button or the Soft key **Select**.

Bluetooth

In the Bluetooth menu you can connect a Bluetooth headset and enable the Bluetooth function. For all information on Bluetooth see [Bluetooth Headset](#) on page 85.

Headset

1. Select **Headset**.

2. Select headset. Choose between **Mic on boom**, **Mic on cable**, **Hearing protection**, or **Customized headset profile**.

Note:

Customized headset profile is only visible if the headset profile has been configured in the PDM or AIWS.

3. Press **Select**.

System

1. Select **System**.

Change System

1. Select **Change system**.
2. Select **Automatic** or a specific system. If the telephone is set to **Automatic** it selects a system according to the priority list, see [Priority](#) on page 56.

Note:

Automatic doesn't work if your system list comprises IP-DECT *and* Integral DECT systems.

Subscribe System

The cordless telephone can subscribe up to eight different systems. To subscribe a new system the "Park:" (Portable Access Right Key) and "Ac:" (Authentication code) related to the system you are going to log on to are needed. Contact your system administrator for more information.

The IPEI code is a unique code which has been assigned to the cordless telephone, see also [Admin Menu](#) on page 76.

1. Select **Subscribe**.
The IPEI of your telephone is displayed.
2. Press Soft key **Next**.
3. Enter System name.
4. Press Soft key **Next**.
5. Select your system.
6. Press Soft key **Next**.
7. Enter PARK code.

Note:

Do *not* enter a #-key at the end of the code.

8. Enter AC code. Press Soft key **Next**.
An information text "Protection on?" is displayed.

9. Select **Yes/No**, if the new system is to be protected. It is not possible to delete a protected subscription.
10. Press Soft key **OK**. A searching mode starts.

Unsubscribe System

1. Select **Unsubscribe** to delete a System subscription.
2. Select **Delete**.

Note:

It is not possible to delete a protected subscription.

Rename System

It is possible to change the name of the system in the telephone.

1. Select **Rename System**.
2. Select system to rename.
3. Enter new name.
4. Select **Save**.

Priority

The default order of priority is the order of entered subscriptions. This means that the first subscribed system has the highest priority. This list can be edited by the user. It is possible to set the systems in priority by moving them up or down in the list.

Note:

This is used in combination with system set to be **Automatic**, see [Change System](#) on page 55.

1. Select **Priority**.
2. Change the priority if needed by selecting **Up** or **Down**. The priority will be saved when **Back** is selected.

In Charger

Redirect Calls and Messages when Placed in Charger

Calls can be redirected to another extension when the cordless telephone is placed in a charger. Then it will not ring when receiving a call. The function is automatically cancelled when the telephone is removed from the charger.

1. Select **In charger**.
2. Select **Redirect**.

Note:

The function and the extension must be programmed in the PBX to be able to redirect calls.

Switch off While Charging

When the cordless telephone is placed in the charger it can be switched off while it is charging. When it is removed from the charger it will switch on again.

1. Select **In charger**.
2. Select **Switch off**.

Deactivate the Charging Mode

1. Select **In charger**.
2. Select **Only charging**.
3. Press **Select** to save the setting.

Calls

1. Enter the menu by pressing the **Menu** Soft key, or the confirmation button on the Navigation key.
2. Select **Calls** icon.
3. Press the confirmation button or the Soft key **Select**.

Call List

The 25 last received, dialled or missed calls are stored in a call list. If a number occurs more than once the last time stamp, together with the total number of occurrences, is shown.

1. Select **Call list**,
2. Step with the ▲ and ▼ to scroll in the list.

Dial number from Call list

1. Select number to call.
2. Press Soft key **Call** to dial.

View the Time of a Call

1. Press Soft key **More**.
2. Select **Time of call**. The time and date is displayed.

Edit Number from Call list

1. Press Soft key **More**.
2. Select **Edit number**.

Save Number

1. Press Soft key **More**.
2. Select **Save number**.

Send Message

1. Press Soft key **More**.
2. Select **Send message**.

Delete Entry from the Call list

1. Press Soft key **More**.
2. Select entry to delete.
3. Select **Delete**.
4. Select **Yes** to delete the entry from the list.

Delete all Entries from the Call list

1. Press Soft key **More**.
2. Select **Delete all**.
3. Select **Yes** to delete all the entries from the list.

Missed Calls

Note:

A call is defined by your telephone as missed if it is not accepted within a time period specified in PDM or AIWS. Accepting the call later an entry in the missed call list is set, though.

1. Select **Missed calls**
2. Step with the ▲ and ▼ to scroll in the list.
3. Press Soft key **Call** to call back.

As in menu **Call list** there is a Soft key **More** which can be used to view the time/date of the call, edit the received number, add to contacts, delete received numbers. See [Call List](#) on page 57 for information about the functionality in Soft key **More**.

Call Time

The total time of the previous call and last call is displayed.

1. Select **Call time**.

Call Services

Note:

These functions are system dependent. The parameters are set up in the PDM or AIWS, see *Installation and Administration Manual, DECT R4*.

Absence Handling

The reason for being absent and the return time can be specified here. When set it is reflected in the AIWS absence list for administrative purposes.

Note:

Redirect in charger must be set to use absence handling.

1. Select **Call services**.
2. Select **Absence**.

If the cordless telephone is preprogrammed a number of absence reasons can be displayed, for example **Lunch, Meeting, Trip** etc.

3. Press Soft key **Select**
4. Enter time or date.

Deactivate the Absence Setting

1. Enter **Call service** in the menu
2. Select **Deactivate**.
3. Press Soft key **Select**.

Divert Calls

The user can divert calls to another extension.

1. Select **Divert calls**.

Divert Internal/External Calls

1. Select **Internal** or **External**.
2. Select **Activate**.
3. Enter number to divert to.
4. Press Soft key **OK**

To stop diversion select **Deactivate** and press the confirmation button or the Soft key **OK**.

Divert Calls if No Reply

1. Select **No reply**.
2. Select **Activate** and press Soft key **OK**.
3. Enter number to divert to.
4. Press Soft key **OK**

To stop diversion select **Deactivate** and press the confirmation button or the Soft key **OK**.

Divert Calls When Busy

1. Select **When busy**.
2. Select **Activate** and press Soft key **OK**.
3. Enter number to divert to.
4. Press Soft key **OK**

To stop diversion select **Deactivate** and press the confirmation button or the Soft key **OK**.

Start a Priority Call

An incoming priority call is signalled with a specific tone and the displayed text **Priority call**. The call cannot be muted or declined.

1. Select **Call services** in the menu **Calls**.
2. Select **Priority Call**.
3. Enter number.

General Purpose

Besides the default Call services functions, it is possible to define 10 extra system specific codes in PDM or AIWS.

Short Cuts

Predefined functions can be set as short cuts for the Soft keys, Hot keys (alphanumeric keys 0, 2 to 9), Navigation keys, and the Multi-function button. It is for example possible to define the Soft key to make a call or as a short cut to send a message.

Note:

All procedures described in this guide are based on standard Short Cuts settings. This means that your telephone settings can differ from this and e. g. the Soft key **Menu** in idle mode is missing.

1. Enter the menu by pressing the **Menu** Soft key, or the confirmation button on the Navigation key.
2. Select **Short cuts** icon.
3. Press the confirmation button or the Soft key **Select**.

Define Soft Keys

1. Select **Soft keys**.
2. Select **Left, Middle, or Right**.
3. Press **Select** to enter a name for the Soft key.
4. Press Soft key **OK**. The default setting of the key is shown.
5. Select **Function**, and press **Select** to select function for the Soft key.
6. Select function from list, and press **Back**.
7. Select **Value** (only for some of the functions), and press **Select**. Enter a value for example a telephone number. Press **Back**.
8. Select **Control question**, and press **Select**. It is off by default. Press **Back**.
9. Press Soft key **Save**.

Define Hot Keys

1. Select **Hot keys**.
2. Select **0, 2 to 9**.
3. Select **Function**, and press **Select** to select function for the Soft key.
4. Select function from list, and press **Back**.
5. Select **Value** (only for some of the functions), and press **Select**. Enter a value for example a telephone number. Press **Back**.
6. Select **Control question**, and press **Select**. It is off by default.
7. Press Soft key **Save**.

Define Navigation Key

1. Select **Navigation keys**.
2. Select **Up, Down, Left, or Right**.
3. Select **Function**, and press **Select** to select function for the Soft key.
4. Select function from list, and press Soft key **Back**.

5. Select **Value** (only for some of the functions), and press **Select**. Enter a value for example a telephone number. Press Soft key **Back**.
6. Select **Control question**, and press **Select**. It is off by default.
7. Press Soft key **Save**.

Define Multi-function Button

The Multi-function button can be defined with two different functions, a long press activates one function, and a double press activates another function.

1. Select **Multi-function button**.
2. Select **Long press**, or **Multi press**.
3. Select **Function**, and press Soft key **Select** to select function.
4. Select function from list, and press Soft key **Select** and then press Soft key **Back**.
5. Select **Value** (only for some of the functions), and press Soft key **Select**. Enter a value for example a telephone number. Press Soft key **Back**.
6. Select **Control question**, and press **Select**. It is off by default.
7. Press Soft key **Save**.

My favourites

In this menu you can store often used numbers. This can be phone call numbers or numbers you want to send a message to.

1. Enter the menu by pressing the **Menu** Soft key, or the confirmation button on the Navigation key.
2. Select **My favourites** icon.
3. Press the confirmation button or the Soft key **Select**.

Add favourites

1. Select **Add new**.
2. Enter name of the new favourite.
3. Press Soft key **OK**.
4. Select **Phone call**, or **Send message**.
5. Enter call number.
This can be a simple call number but even a complex combination of feature access code and call number, e. g. to realize a specific feature.

6. Press **Save**.

Delete favourites

1. Select favourite you want or delete.
2. Select **More**.
3. Select **Delete**.
4. Select **Yes** to delete the favourite.

Messaging

1. Enter the menu by pressing the **Menu** Soft key, or the confirmation button on the Navigation key.
2. Select **Messaging** icon.
3. Press the confirmation button or the Soft key **Select**.

Inbox

1. Select **Inbox** to view the message list.
2. Select a message by using the ▲ and ▼ on the navigation key.

Read a Stored Message

1. Press Soft key **View** to read the message.

Reply to Sender

1. Select **View**.
2. Select **Reply**.
3. Enter text.
4. Select **Send**.

Delete Message

1. Select **More**.
2. Select **Delete**.
3. Select **Yes** to delete the message.

Forward Message

1. Select **View**.
2. Select **More**.
3. Select **Forward**.
4. Enter additional text if needed.
5. Select **Send**
6. Enter number.
7. Select **Send** to forward the message.

Call Sender

1. Select **View**.
2. Select **More**.
3. Select **Call Sender**.

Call number in text

If the sender has written a telephone number in the message it is possible to call the number without dialling it.

1. Select **View**.
2. Select **More**.
3. Select **Call (No. in text)**.
4. Select number from the list.
5. Select **Call**.

Save Number

1. Select **View**.
2. Select **More**.
3. Select **Save number**.
4. Select **Work Number/Mobile number/Other number**.
5. Press Soft key **Add**.
6. Enter name for the contact.
7. Press Soft key **OK**.
8. Press Soft key **Save**. The number will be saved in the contact list.

Write New Messages

1. Select **Write new message**.
2. Enter text.
3. Press **Send**. See also [Messaging](#) on page 52.
It is possible to save the message and send it later by pressing the Soft key **Back** and select **Yes**. The message will be stored under **Unsent messages**. See [Unsent Messages](#) on page 65.
4. Enter number, or press middle Soft key to get number from contact list.
5. Press **Send**.

Unsent Messages

1. Select **Unsent** to view the list.
2. Select message to edit/send.
3. Select **Edit**, edit text and/or just select **Send**.

Delete/Delete All

1. Select **More**.
2. Select **Delete** or **Delete all**.
3. Select **Yes** if the unsent message shall be deleted.

Sent Messages

1. Select **Sent** to view the list.
2. Select a message by using the ▲ and ▼ on the navigation key.

Delete/Delete all

1. Select **More**.
2. Select **Delete** or **Delete all**.
3. Select **Yes** if the unsent message shall be deleted.

Read a sent Message

1. Select **View** to read the message.

Forward message to another Destination

1. Select **View**.
2. Select **Forw.**

3. Enter additional text if needed.
4. Select **Send**.
5. Enter number.
6. Select **Send**.

Call number in text

If the sender has written a telephone number in the message it is possible to call the number without dialling it.

1. Select **View**.
2. Select **More**.
3. Select **Call (No. in text)**.
4. Select number from the list.
5. Select **Call**

Save Number

1. Select **View**.
2. Select **More**.
3. Select **Save number**.
4. Select **Work Number/Mobile number/Other number**.
5. Press Soft key **Add**.
6. Enter name for the contact.
7. Press Soft key **OK**.
8. Press Soft key **Save**. The number will be saved in the contact list.

Profiles

It is possible to set up an own profile for incoming calls, message alerts, vibrating alerts, key sound etc. This can be useful when there are many users on the same telephone, and they want different sound profiles. It can also be used for temporarily settings, for example while in a meeting incoming calls should be silent. It is easy to switch between the different profiles.

Note:

Changing settings is not possible on a telephone which is set to a profile. You have to leave the profile before.

1. Enter the menu by pressing the **Menu** Soft key, or the confirmation button on the Navigation key.

2. Select **Profiles** icon.
3. Press the confirmation button or the Soft key **Select**.

Add new Profile

1. Press Soft key **Add new**.
2. Enter name of the profile and select **Save**.
3. Select profile from list and change profile as wanted.

Delete Profile

1. Select profile from list.
2. Press Soft key **More**.
3. Select **Delete** from menu.
4. Press Soft key **Delete**.
5. Press Soft key **Yes** to confirm.

Edit Profile

1. Select profile from list.
2. Press Soft key **More**.
3. Select **Edit** from menu.
4. Select what to edit and press Soft key **Edit**.
5. Make changes and press Soft key **Save** to confirm.

Contacts

The telephone has a personal phonebook with 250 entries, where names and numbers freely can be added, deleted, and edited by the user. The phonebook lists all names in alphabetical order, where three numbers can be added for each contact; work number, mobile number, and other number.

It is also possible to access a central phonebook. The user then sends a request to a messaging server with the first characters entered, and the messaging server will return a list of names and numbers that matches the search.

A company phonebook can be downloaded via the PDM. Contacts from the Company phonebook appears in the contacts list menu with a lock symbol next to the name/number, which means that it is not editable. The contact will only include work number.

1. Enter the menu by pressing the **Menu** Soft key, or the confirmation button on the Navigation key.

2. Select **Contacts** icon.
3. Press the confirmation button or the Soft key **Select**.

Call Contact

1. Select **Call contact**.
2. Select contact from the list, or enter name in the search field.
3. Press Soft key **Call**.

It is also possible to edit the contact and to send a message by selecting **View > More**.

Add Contact

1. Select **Add contact**.

Add New Contact

1. Select **New**.
2. Select **Add**, and enter the name of the contact.
3. Press Soft key **OK**.
4. Select **Work Number/Mobile number/Other number**.
5. Press Soft key **Add**.
6. Enter telephone numbers.
7. Press Soft key **OK**.
8. Press Soft key **Save** and then **Back**.

Different ring signals can be set to distinguish this contact from another contact.

Add from Call List

1. Select **From call list**.
2. Select number.
3. Press Soft key **Add**.
4. Select number type.
5. Press Soft key **Select**.
6. Press Soft key **Add**, and enter name for the contact.
7. Press Soft key **OK**.
8. Press Soft key **Save**.

Edit Contact

1. Select **Edit contact**.
2. Select contact, and press Soft key **Edit** twice.
3. Enter new name/number, and press **OK**.
4. Press Soft key **Save**.

Delete Contact

1. Select **Delete contact**.
2. Select contact, and press **Delete**.
3. Press Soft key **Yes** to confirm.

Central Phonebook

In the Central phonebook it is possible to search by name or number. The last search result can be displayed.

When the search result is ready it is possible to view contact information, add the number to new contact, and to send a message by selecting the Soft key **More**. You can also call the number by selecting the Soft key **Call**.

1. Select **Central phonebook**.

Search by Name

1. Select **Search by name**.
2. Enter First name and/or Last name.
3. Select **Search**.
The search result will be displayed.

Search by Number

1. Select **Search by number**.
2. Enter telephone number.
3. Select **Search**.
The search result is displayed.

View Last Search Result

1. Select **Last result**.
Only the last result will be displayed.

Settings

1. Enter the menu by pressing the **Menu** Soft key, or the confirmation button on the Navigation key.
2. Select **Settings** icon.
3. Press the confirmation button or the Soft key **Select**.

Sound and Alert Settings

Adjust the Ringer Volume

1. Select **Sound & Alerts**.
2. Select **Volume**.
3. Step with **▶** to increase the volume and with **◀** to decrease it.
4. Press Soft key **OK** to save the setting.

Note:

When the volume is set to silent the  icon is shown in the display.

Set different Ring Signals for Internal Call, External Call and Priority Call

Different signals for internal calls, external calls and priority calls can be set. The cordless telephone has 14 different ring signals.

1. Select **Sound & Alerts**.
2. Select **Ring signals**.
3. Select **Internal call**, **External call** or **Priority call**.
4. Select sound. By pressing **Play** it is possible to listen to the different sounds.
5. Press Soft key **Back**.

Set different Message Alerts for Mail

Different message alerts can be selected. The cordless telephone has 8 different message alerts (default), see [Settings](#) on page 40.

1. Select **Sound & Alerts**.
2. Select **Message alert**.
3. Select message alert from list. By pressing **Play** it is possible to listen to the different sounds.
4. Press Soft key **Back**.

Turn the Vibrator on/off

1. Select **Sound & Alerts**.
2. Select **Vibrating alert**. Choose between **On**, **On if silent** (i.e. the vibrator is on when the telephone is muted), or **Off**.
3. Select vibrating alert.
4. Press Soft key **Back**.

Set the Key Sound

This means that every time a key is pressed, the telephone gives a small sound. You can choose between **Silent**, **Click**, or **Tone**.

1. Select **Sound & Alerts**.
2. Select **Key sound**.
3. Select key sound.
4. Press Soft key **Back**.

It is possible to listen to the key sound by pressing the Soft key **Play**.

Phone Lock settings

Activate the Automatic Key Lock

1. Select **Locks**.
2. Select **Automatic key lock**.
3. Select **On** for activation of automatic key lock.

Activate the Phone Lock

The telephone can be protected for unauthorized use. If this function is set to **On** it locks automatically a short time after the last keystroke and a PIN code has to be entered at power on. When it is set to **On in charger** it locks when switched off or placed in a charger. The default phone lock code (0000) can be changed to any 4 -8 digit personalized code.

Note:

If the PIN code is forgotten it can be removed by your administrator.

1. Select **Locks**.
2. Select **Phone lock**.
3. Select **Auto phone lock**.
4. Select **On**, or **On in charger**.
5. Enter PIN code
6. Press Soft key **OK**.

Deactivate the Phone Lock

1. Select **Locks**.
2. Select **Phone lock**.
3. Select **Auto phone lock**.
4. Select **Off**.
5. Enter PIN code
6. Press Soft key **OK**.

Change PIN Code

1. Select **Locks**.
2. Select **Phone lock**.
3. Select **Change PIN code**.
4. Enter the old PIN code.
5. Press Soft key **OK**.
6. Enter the new PIN code.
7. Scroll down with ▼ to **Confirm PIN code**.
8. Enter the new PIN code again.
9. Press Soft key **Save**.

Display Settings

Brightness

1. Select **Display**.
2. Select **Brightness**.
3. Select **Normal** or **Power save**.
4. Press Soft key **Back**.

Screen Saver

Time and status information will be displayed when **Information** is selected, and the display will turn off when the telephone is not used.

1. Select **Display**.
2. Select **Screen saver**.
3. Select **Information**, or **Black**.
4. Press Soft key **Back**.

Time & Date Settings

Time and date is set in your PBX. Changes appear in the telephone after a maximum of 24 hours after the change or by turning the telephone off and on again.

Set Time Format

1. Select **Time & Date** and press **Select**.
2. Select **Time format**. The actual time format will be displayed. Selectable time format:
 - 11:00pm
 - 23:00
3. Press **Select** to save the setting.

Set Date Format

1. Select **Time & Date** and press **Select**.
2. Select **Date format**, press **Select**. Selectable date format:
 - DD/MM/YYYY, e.g. 17/09/2008 (also called Europe)
 - MM/DD/YYYY, e.g.. 9/17/2008 (also called US)
 - YYYY-MM-DD, e.g. 2008-09-17 (ISO 8601)
 - MMM DD YYYY, e.g. Sept 17 2008
 - DD MMM YY, e.g. 17 Sept 08
 - DD.MM.YYYY, e.g. 17.09.2008
 - DD-MM-YYYY, e.g. 17-09-2008
3. Press **Select** to save the setting.

Answering

The default setting for the telephone is to use the Off-hook key when answering a call. The answering behaviour can be configured to answer the call automatically, i.e. without pressing a key, or/and in loudspeaking mode. It is also possible to set the answering behaviour to any key or hook-off.

Note:

The automatically answer mode is only relevant when a headset is connected.

1. Select **Answering**.

Answering Key

The answering key is by default set to **Hook-off**. It can also be set to **Any key**.

1. Select **Answering key**.

2. Mark **Any key** or **Hook-off**.
3. Press Soft key **Back** to save the setting.

Answering Behaviour

1. Select **Answering behavior**.
2. Select **Automatically / Loudspeaking**.
3. Press Soft key **Change** to change the setting. The check box will be marked. To remove the setting, press Soft key **Change** again.
4. Press Soft key **Back** to save the setting.

Change Text size for Messages

1. Select **Messages**.
2. Select **Text size Normal**. The default text size is **Normal**.
3. Select **Normal** or **Large**.

Change the Menu Language

You can choose between; Brazilian, Brazilian Português (Brazilian Portuguese), Čeština (Czech), Dansk (Danish), Deutsch (German), English, Español (Spanish), Français (French), Ελληνικά(Greek), Magyar (Hungarian), Italiano (Italian), Nederlands (Dutch), Norsk (Norwegian), Polski (Polish), Русский (Russian), Slovenčina (Slovakian), Soumi (Finnish), Svenska (Swedish) and Türkçe (Turkish).

Note:

In every language the menu item ***language** is shown with a prefixed Asterisk "*". This might help you to change the language of a telephone set to a language you do not understand.

1. Select ***Language**.
2. Select language.
3. Press Soft key **Select** to save the setting.

Change Owner ID

The Owner ID is set to identify the telephone and it's shown in the idle display.

1. Select **Owner ID**.
2. Enter identity.
3. Press Soft key **Save**.

Device info

This is where software and hardware information of the cordless telephone is found.

1. Select **Device info**.
2. Depending on the info your are looking for select **Software**, **Hardware**, **IPEI/IPDI**, or **USER ID**.

Advanced Functions

Admin Menu

The telephone has a hidden menu for system administrators. See also *Installation and Administration Manual, DECT R4*.

The Admin menu contains:

- Software and hardware information, IPEI/IPDI and user ID
- DECT information
- Centralized Management showing online information
- Fault logging
- Factory reset option
- System menu with ability to alter protection
- Site Survey Tool for indication of radio signal and base station listing.

For activating the admin menu see *Installation and Administration Manual, DECT R4*.

For quick access to device information short codes are available in the idle menu.

Information	Code
Software version	*#34#
Hardware version	*#34#
IPEI	*#06#
IPDI	*#06#

Clear Lists in Charger

Via PDM or AIWS it is possible to set a parameter that will clear messaging lists and call lists that has been stored in the cordless telephone. When the parameter is activated and the function has been downloaded to the cordless telephone, the lists will be deleted when placed in a charger. This can be useful during administration of cordless telephones for new users. See also *Installation and Administration Manual, DECT R4*.

System Handling

Software Upgrade

Software and parameters in the Avaya 3725 DECT Telephone can be upgraded by using the PDM or the AIWS. See *Installation and Administration Manual, DECT R4*.

To view the telephone's software version, enter `*#34#` in idle mode.

Troubleshooting

This section contains information on how to solve common operational problems, and warnings you may receive.

Go through the following lists if you encounter any problems. If this checklist does not solve the problem, contact your system administrator.

If others have similar problems, there may be a system error.

Operational Problems

Fault	Probable cause	Action or comment
No display	The battery level is low or the telephone is defective.	Charge the battery or contact system administrator.
No ringing	The sound off icon is on, or ringer volume set to silent, or the telephone is defective.	Long press the Sound off key, or increase volume, or contact system administrator.
No change in time & date setting	PBX dependent.	Changes in the telephone appear after a maximum of 24 hours after a change in the system or by tuning the telephone off and on again.

Error or Warning Messages

Display shows	Probable cause	Action or comment
No access	The network is in range, but no access rights.	Switch telephone off and then switch it on again or contact system administrator.
No System. The telephone beeps once a minute (during max 30 minutes) with a low tone followed by a high tone (if enabled, the vibrator also follows the beeps).	The telephone is out of coverage or telephone is defective.	Stop the beep with the Sound off key and go into range. Note: When re-entering the coverage area it can take a couple of minutes before the telephone automatically has registered into the system. or contact system administrator.

Display shows	Probable cause	Action or comment
SERVICE NEEDED Parameters corrupt	The telephone is defective.	Select reset option on the middle Soft key if available or if no reset option is available or fault does not resolve the telephone needs repair. Note: Display message only shown in English.
Enter PIN code	The telephone's lock is activated.	Enter the required PIN code. If PIN code lost enter new via PDM or do a factory reset via PDM.
Battery low, charge now	The battery level is low.	Charge or replace the battery.
Phonebook is not available at the moment.	The phonebook does not respond, not available at the moment.	Try again later or if fault persists do a factory reset via admin menu or PDM.
Voice mail number not defined	There is no Voice mail number defined in the telephone.	Define a Voice mail number via PDM.

Operation Notice

Accessibility and Voice Quality

The base network is not always available. If you do not get in contact with your system, contact your system administrator. For best voice quality, avoid positioning near computer, radio or similar equipment.

Operating Area

You can only use your cordless telephone in the area that is covered by your system. Outside this area you will lose contact with the system. The signal strength icon will be low and **Searching** will be displayed.

Out of Range

When you leave the system's coverage area a short beep will sound and the text **Searching** will appear in the display.

The out of range beep will be repeated every minute for 30 minutes. It is possible to turn the sound off by pressing the Sound off button, see [Descriptions](#) on page 20.

When re-entering the coverage area it can take a couple of minutes before the telephone automatically has registered into the system.

Maintenance

Charge the Battery

Place the telephone in the desktop charger or in the rack charger. The battery is being charged when the LED on the telephone is steady orange. When the battery is fully charged the LED will be green.

 An animated battery icon is also shown in the display indicating charging by starting with its current charge and ending with the full charge. A filled Battery icon indicates a fully charged battery.

Note:

Only use the prescribed chargers for charging.

Charge Spare Batteries

Spare batteries can be charged with a separate Multiple Battery Charger. It can charge six batteries at the same time.

Replace the Battery

If the standby time for the cordless telephone becomes too low, the battery should be replaced by a new one. Please contact your system administrator or your supplier, for information about new batteries. Attach the battery as described in the illustration below. The battery is easy to replace. It is attached inside the battery lid and is connected to the cordless telephone in such a way that no miss-contact is possible.

Figure 6: Easy replaceable battery, unlock the lid and remove the battery

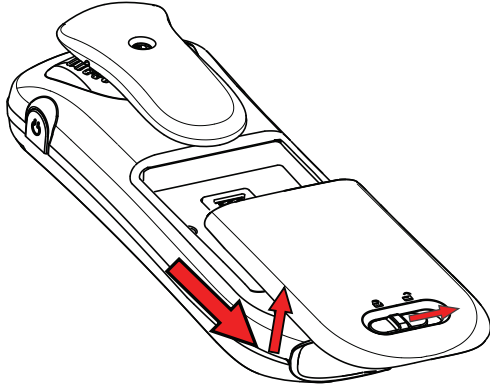

Attach the Hinge-type Clip

Attach the hinge-type belt clip as described in the illustration below.

Figure 7: Screw the hinge-type clip into position

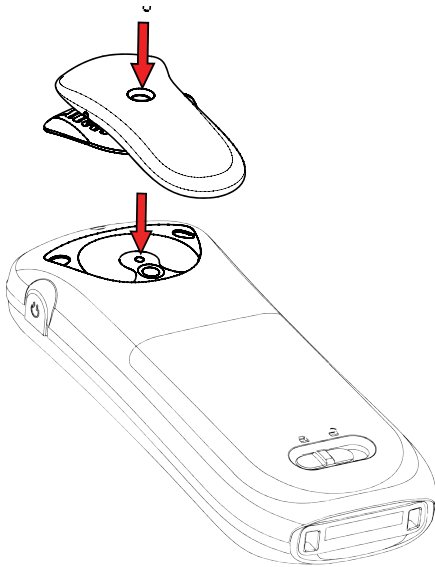

Attach the Swivel-type Clip

Attach the swivel-type belt clip as described in the illustration below.

Figure 8: Screw the swivel-type clip into position

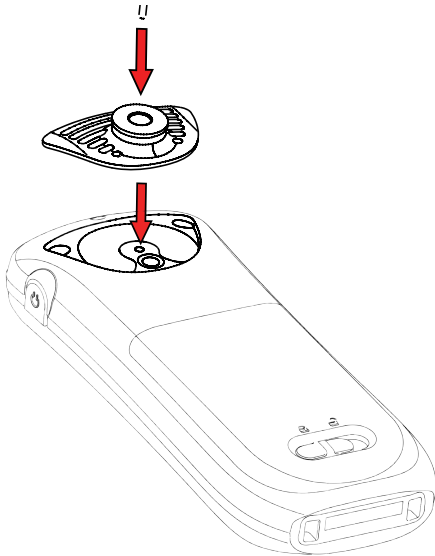

Attach Cover for No Clip

Attach the enclosed cover as described in the illustration below when no clip is to be used.

Figure 9: Screw the cover into position

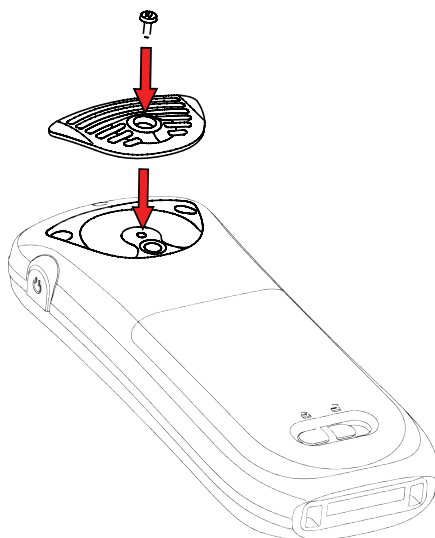

Bluetooth Headset

Introduction

Bluetooth technology replaces the cord between the cordless telephone and the headset. This allows the user to move more freely and eliminates the risk of a headset cord getting stuck.

The Bluetooth is factory mounted on the cordless telephone's circuit board.

Bluetooth supported functions:

- Pair the cordless telephone with its headset
- Choose which device to use when making a call
- Play ring signal in the Bluetooth Headset
- Answer and connect sound to the Bluetooth Headset when answering with the headset's button.
- End call with the Bluetooth headset's button
- Transfer audio to/from Bluetooth headset during call, using the menu in the cordless telephone.
- Increase/decrease the volume in the Bluetooth headset with the volume buttons on the cordless telephone.

Wear

For optimal performance wear the Bluetooth headset and the telephone on the same side of your body. The best audio quality in the headset is achieved when no obstructions, including your body, are between the headset and the cordless telephone.

Figure 1: Wear the headset and the telephone on the same side of your body.

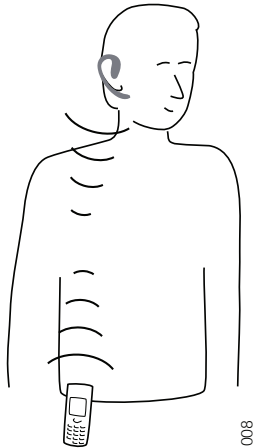

Headsets

A number of Bluetooth headsets for different work situations have been tested together with the telephone. Refer to the *Installation and Administration Manual, DECT R4* for a list of verified Bluetooth headsets.

Since the Bluetooth supports the Bluetooth 2.0 standard, other headsets may also work although not verified by Avaya.

Note:

Your Bluetooth headset may have more or less functions than described here, refer to the Manual for the Bluetooth headset.

Operation

Step between the menus with the navigation key. Confirm each menu selection by pressing the Soft key **Select**.

Enable Bluetooth

1. Enter the menu by pressing the **Menu** Soft key, or the confirmation button on the navigation key.
2. Select **Connections** icon.
3. Select **Bluetooth**.
4. Select **Enable**. A Bluetooth connection icon  will be displayed in the header bar.

Note:

To disable Bluetooth again select **Disable**.

Pair and Connect a Bluetooth Headset

Before a headset can be used a connection (pairing) between the headset and the telephone must be established.

1. Place the Bluetooth headset and the telephone next to each other.
2. Select **Connections** icon in the telephone menu.
3. Select **Bluetooth > Headset > Add new**.
4. Put the headset in pairing mode and press the Soft key **OK**. The telephone starts to search for the headset.

Note:

For instruction, see headset manual.

5. The headset is displayed in the telephone menu **Headset found**. Press the Soft key **Select** on the telephone to select the headset. The pairing starts.
6. A PIN-code is requested for the Bluetooth headset. Enter the PIN-code and press **Select** on the telephone. **Pairing successful** is displayed.

Note:

For instruction, see headset manual.

7. The paired headset is displayed in the telephone menu **Headset**. When pairing a new headset it is automatically connected and will be used for calls.

Add another Bluetooth Headset

Up to four headsets can be paired to the telephone, but only one at a time can be selected. To pair another headset repeat section "Pair and Connect a headset" steps 1-6.

The paired headsets are displayed by a default name in the telephone menu **Headset**. See 6. *Confirm with the Soft key Select.*

Select a Bluetooth Headset

1. Select **Connections** icon in the telephone menu.
2. Select **Bluetooth > Headset**.
3. Step with the navigation key, ▲ or ▼ to the headset to be selected.
4. Press the Soft key **Select**, **Connection successful** is displayed. The headset is now selected.

When a new headset has been selected any previous headset will automatically become disconnected.

Remove a Headset

1. Select **Connections** icon in the telephone menu.
2. Select **Bluetooth > Headset**.
3. Step with the navigation key, ▲ or ▼ to the headset to be removed.
4. Press the Soft key **More**.
5. Select **Delete**.
6. Confirm with the Soft key **Select**.

Change the name of Bluetooth headset.

The name, in the headset list, of the headset is the default name for the headset.

1. Select **Connections** icon in the telephone menu.
2. Select **Bluetooth > Headset**.
3. Step with the navigation key, ▲ or ▼, select the headset.
4. Select **More > Edit name**.
5. See [Alphanumeric Keys](#) on page 30.

Calling

Make a Call

1. Enter the number on the telephone.
2. Press the Soft key **Call** or the **Off-hook** key.
3. When **Transfer call to phone?** is displayed press **No** or ignore the message to use the Bluetooth Headset.
4. Press **Yes** to use the telephone.

Answer a Call

A ring signal sounds in both the selected Bluetooth headset and the telephone to signal an incoming call.

To answer the call in the Bluetooth headset, press the button* on the headset.

To answer the call in the telephone press the **Off-hook** key on the telephone.

End a Call

Press the button* on the headset or the **On-hook** key on the telephone.

Volume/Mute Control

Adjust the Volume During a Call

Press the upper **Volume up** button on the upper left side of the telephone to increase the volume and the **Volume down** button to decrease the volume in the headset.

Depending on the Bluetooth headset it might be possible to adjust the volume directly on the headset*.

Turn the Microphone On/Off During a Call

Mute the headset and the telephone with the **Sound off** key on the telephone. See [Switch the Telephone On/Off](#) on page 43.

Messaging

When a text message is received a beep sounds in the Bluetooth headset.

Transfer a call

Transfer a Call to the Telephone

You are on a call with the Bluetooth Headset.

1. Press the Soft key **More** on the telephone.
2. Select **Audio transfer**.

Transfer a Call to the Bluetooth Headset

You are on a call with the telephone.

1. Press the Soft key **More** on the telephone

2. Select **Audio transfer**.

It is also possible to transfer a call to the Bluetooth headset by pressing the button* on the Bluetooth headset.

Switch to a Headset with Cord

If a headset with a cord is connected during a call, the call is transferred to this headset automatically.

Menu Tree

See [Settings](#) on page 40.

Operation Notice

Accessibility and Voice quality

Bluetooth uses the frequency of 2.45 GHz. WLAN, microwave oven, and other devices that use the same frequency can disturb the use of a Bluetooth headset.

Operation Area

Maximum distance between the headset and the telephone is 10 metres. The communication distance between the telephone and headset may vary considerably due to the environment and disturbances from other 2.45 GHz equipment. Different headsets can also give different communication distances.

Out of Range

If a connection cannot be made with the selected Bluetooth headset the call is transferred automatically to the telephone.

If the Bluetooth headset and the telephone get out of range from each other the connection is temporarily lost. Since the last connected headset is always considered **selected**, the connection is automatically established again when a call is made or received.

Environmental Requirements

Bluetooth Headset Battery

See the manual for the Bluetooth headset.

Troubleshooting

Problem	Reason	Solution
No headset found	Headset is turned off	Turn on headset
	Headset is out of battery	Charge headset
	Headset is out of range	Move headset closer to telephone < 10 meter.
	Headset is not in pairing mode	Turn headset into pairing mode (see headset manual for details)
Pairing fails	Headset is not in pairing mode	Turn headset into pairing/discoverable mode (see headset manual for details)
	Incorrect PIN entered	Try again and enter correct PIN (see headset manual for details)
Connecting fails/Failed to connect headset	Headset is not turned on	Turn on headset
	Headset is out of range	Move headset closer to telephone
	Link key in headset has been deleted	Repeat pairing procedure
	Headset is already connected to another telephone	Disconnect headset from the other telephone
	Too close to disturbing devices.	Disturbing devices can be WLAN equipment, microwave etc.
Headset can not connect to telephone (see headset manual for details on how to connect)	Telephone is not turned on	Turn on telephone

Problem	Reason	Solution
	Telephone is out of range	Move telephone closer to headset
	Bluetooth module is disabled	Enable Bluetooth in Bluetooth menu
	Another headset is already connected to the telephone	Disconnect the connected headset
	Link key is missing in either headset or telephone.	Repeat pairing procedure
	Too close to disturbing devices.	Disturbing devices can be WLAN equipment, microwave etc.





















Avaya 3725 DECT Telephone

Quick Reference Guide



Display Icons

-  Signal strength
-  Battery status
-  Voice mail
-  Microphone off
-  Ring volume set to silent
-  Loudspeaker on
-  Loudspeaker off
-  Sound off
-  Headset connected
-  Bluetooth headset connected
-  Bluetooth
-  New message
-  Read message
-  Missed call
-  Incoming call
-  Outgoing call
-  System connection
-  Key lock
-  Phone lock

Product presentation

The cordless telephone is a feature-rich handset with colour display, telephony, messaging, and bluetooth. It is designed to be used in office environment and medium demanding environment such as hospital environment.

It is suitable for users dependent of being reachable and/or having a need for mobile voice and messaging features, which makes it ideal for applications where the user needs either one way messaging or to be able to interact with other users. The colour display enhances and simplifies the use of the cordless telephone.

Read the safety instructions before use.

For software download and parameter set up, read the *Installation and Administration Manual, IP DECT*

Functions	3725
<i>Local phonebook (250 contacts)</i>	X
<i>Central phonebook</i>	X*
<i>Company phonebook</i>	X
<i>Vibrator</i>	X
<i>Headset connector</i>	X
<i>Microphone on/off during call</i>	X
<i>Loudspeaking function</i>	X
<i>SMS (Short Message Service)</i>	X*
<i>Voice mail access</i>	X*
<i>Centralized management</i>	X*
<i>Easy replaceable battery</i>	X
<i>Bluetooth</i>	X

* System dependent

Note: Your unit may have more functions than described here; see *User Guide, Avaya 3725 DECT Telephone*.

Basic functions

Switch the telephone on/off

Press and hold the **On-Hook** key  until pop-up question is displayed.

Make a call

Dialling can be made in the following ways:

- In idle screen, dial the number and press the **Off-hook**

key .

- Press the **Off-hook** key  and enter the number.
- Press a pre-programmed Hot key* or Soft key.
- Dial a number from the local phonebook. Enter the

Contacts menu, select **Call contact** and select the name

- from the list, press **Call** or the **Off-hook** key .
- Dial a number from the Central phonebook. Enter the

Contacts menu, select **Central phonebook > search by name/number/last result**, and press **Search**. Press **Off-**

hook key .

* *The alpha-numeric keys can be programmed with a telephone number.*

Answer/End a call

When the ring signal sounds; press the **Off-hook** key  to answer.

To end the call, press the **On-hook** key .

Turn loudspeaking function on/off



During a call, press the left Soft key to turn the loudspeaking function on/off.

Turn audio signals on/off

In idle mode a long press on the **Sound off** key changes between audio signals on/off. The **Sound off** icon  indicates a completely silenced telephone.

- A short press on the **Sound off** key before answering a call, silences the ring signal.

Lock/Unlock the keypad manually

Press the -key to lock/unlock and then Soft key **Lock/Yes**. The **Locked keypad** icon  indicates a locked keypad.

Change the volume during a call

Press the Volume button upwards to increase the volume, downwards to decrease the volume. Or, use the Navigation key to adjust the volume.

Charge the battery

Charging is done in a desktop charger or in a charging rack. Charging is indicated by orange LED. When the battery is fully charged the LED is green and a fully charged **Battery** icon  is displayed.

While in a desktop charger the telephone is fully operational. The telephone does not vibrate in charger.

The battery can also be charged in a separate battery pack charger.

Note: Charging below 5°C will harm the battery and shorten the lifetime.

Remove the battery

It is recommended to switch off the telephone before removing the battery.

Messaging



Receive a text message

When a text message is received, the LED starts flashing and a message tone sounds. A pop-up **New message(s):1 View now?** is displayed and the Soft keys **Yes/No** to read

the message now or later. The message is then stored in the message list. The **New message** icon  is shown in the display.

If the message is received during a call, the user is notified by a beep.

Read a stored message

Open the Message list, either from the messaging menu or by pressing the Navigation key  in Idle screen. Use the Navigation key  to navigate in the Message list. Select message and press the soft key **View** to read the message.

Send message

Open the Messaging menu , and select **Write new message**. Enter text, press the soft key **Send**, and then enter a number, or press the middle soft key for phonebook look-up. Press **Send**.

Delete a stored message

To delete a message, select message and press the soft key **More**, select **Delete**, and press the soft key **Yes**.

Check voice mail

A new voice mail is indicated by a pop-up and the  icon. Only one voice mail at the time will be displayed in the message list.

Open the **Messaging** menu, select **Inbox**, select , press the soft key **View**, and press **Call**.

or

A long press on digit key **1** will call your voice mail. If the extension number is not available a pop-up **Voice mail number not defined** is displayed. See *User Guide, Avaya 3725 DECT Telephone*.

Menu

For descriptions of all functions; see *User Manual, Cordless Telephone 3725*.

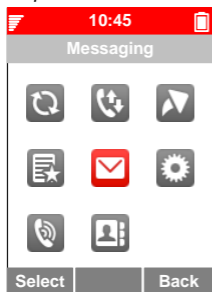

Navigate the menu

Use the Navigation key to move around in the menu structure.

The menus are; **Connections, Calls, Short cuts, My favourites, Messaging, Settings, Profiles, and Contacts.**

The three Soft keys below the display are used for choices in the menu. The function of each Soft key is explained by text in the soft key field in the display.

Use the local phonebook

To find and call a name: Enter **Contacts** , step to **Call contact** and press **Select**. Enter the first letter in the name or the whole name (will be displayed in Search field while entering text), or step in the contact list. Select the name and press **Call**.

To edit the contact: Select **Edit contact**, select the name and press **Edit**. Make your changes, press **OK** and then press **Save**.

To add a contact, select **Add contact**, select **New** or **From call list**. Press **Add**, enter the name and press **OK**. Select **Number**, enter the number, press **OK** and press **Save**.

To delete a contact: select **Delete contact**, select the name, press **Delete**, and then press **Yes**.

Use the central phonebook

Enter **Contacts** , and select **Central phonebook**. Select **Search by name**, **Search by number**, or **Last result**. Enter the first letter(s) in the first name, and/or the first letter(s) in the family name. Press **Search**. The Central phonebook will be searched and a list of matching names will be displayed. You can step to the next entry in alphabetic order by pressing the Navigation key. Press

More to add contact, or press **Call** or the Call key  to make the call.

Use the company phonebook

The company phonebook has to be imported via the PDM before it will be visible in the handset. See *User Manual, Cordless Telephone 3725*.



Enter **Call list**. A contact from the company phonebook is marked with the  symbol. Select name/number and press **Call**, only work number is available for the contact and it is not editable.

Soft keys, Hot keys and Multifunction button

The three Soft keys below the display can be defined for specific functions such as dialling a specific number. A long press on a Hot key can have the same function as a Soft key and any key **0**, **2** - **9** can be programmed as a Hot key. The Multifunction button can also be programmed for different functions with the use of long press and double press.

For more information about Soft keys, Hot keys and Multifunction button, see *User Guide, Avaya 3725 DECT Telephone*.

Turn the automatic keypad lock on/off

Enter **Settings** , and step to **Locks**. Select **Automatic key lock Off/On**, select **On/Off**, and press **Back**. A locked keypad is indicated by the **Key lock** icon .

To unlock,press the key , and then the Soft key **Yes**.

Accessories

The following accessories for the Avaya 3725 DECT Telephone are available:



Leather casing incl. belt clip



Belt clip, swivel type



Standard clip

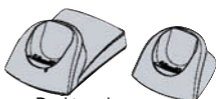

Desktop chargers



Headset with microphone
on boom

Also available:

- Telephone lanyard
- Rackmount Charger
- Multiple Battery Charger

Index

A

Accessories	18, 31
Admin Menu	76
Alphanumeric keys	30
Antenna	21

B

Battery	21, 81
charge	81
full battery icon	25
low battery	81
low battery icon	25
Belt Clips	31
Bluetooth headset	54, 85
calling	88
enable	86
pairing	87
verified types	86

C

Call answering	45
Call back	50
Call declining	45
Call diversion	59
Call info	33
Call list	57
Call Services	59
Call Waiting	50
Calling	
call a number from the call list	45
dial a number	45
quick call by a name in the phonebook	47
Calls	
menu tree	33
Case	21
Central phonebook	67
Charger	22
disconnect telephone	23
telephone behaviour	56
Chemical resistance	16

Clip	21
Company phonebook	67
Conference Call	50
Connections	
menu tree	39
Contacts	67
menu tree	35

D

Dispose of old equipment	11
Divert Calls	59
DTMF	50

E

Earpiece	21
----------	----

F

Favourites	62
menu tree	38
Frequency range	13

H

Handsfree key	20
Headset connector	20
Hot keys	29

I

Icons	25
Idle mode	
date	24
time	24
user identity	24
In Call	
menu tree	41

K

Key sound	71
Keypad lock key	29

L

Language	74
Lanyard	31
Lock/unlock	
keypad	43
telephone	44
Loudspeaker	21
Loudspeaking	25, 45
icon	25

M

Menu icons	26
Message	
new message	25, 52
old message icon	25
receive	52
send	52
voice message icon	25
Messaging	63
menu tree	37
Microphone	21
on/off	48
Missed calls list	58
Multifunction Button	29
Mute button	30

N

Navigation/Confirmation key	28
Number input mode	30

O

Off-hook key	28
On/Off key	28
On-hook key	28
Operating area	80
Out of coverage	80

P

Personal phonebook	67
Phone lock	71
PIN code	71
Profiles	66

menu tree	36
-----------------	----

Q

Quick Reference Guide	93
-----------------------------	----

R

Ring signals	70
Ring volume	70

S

Safety Information	9
Settings	70
menu tree	40
Short cuts	60
menu tree	38
Signal strength icon	25
Sound off button	30
Special characters	52
Switch between Calls	49
Switch telephone on/off	43
System	
change	55
subscribe	55
unsubscribe	56

T

Text input mode	31
Transfer Call	49
Troubleshooting	78
Bluetooth	91

V

Vibrator	71
Voice mail	53
key	28
Voice quality	80
Volume	
adjust during a call	47
button	29
ringer	70
speaker	20

W

Writing Text/Numbers

add space in text	31
pause	30
upper/lower case	31

