



Avaya 3740 and 3749 DECT Telephones

connected to
Avaya Aura[®] Communication Manager
and IP Office

User Guide

21-603690
11/2010
Issue 2.0

© 2010 Avaya Inc.
All Rights Reserved.

Notice

While reasonable efforts were made to ensure that the information in this document was complete and accurate at the time of printing, Avaya Inc. can assume no liability for any errors. Changes and corrections to the information in this document may be incorporated in future releases.

For full legal page information, please see the complete document, Avaya Legal Page for Hardware Documentation, Document number 03-600759.

To locate this document on our Web site, simply go to <http://www.avaya.com/support> and search for the document number in the search box.

Documentation disclaimer

Avaya Inc. is not responsible for any modifications, additions, or deletions to the original published version of this documentation unless such modifications, additions, or deletions were performed by Avaya. Customer and/or End User agree to indemnify and hold harmless Avaya, Avaya's agents, servants and employees against all claims, lawsuits, demands and judgments arising out of, or in connection with, subsequent modifications, additions or deletions to this documentation to the extent made by the Customer or End User.

Link disclaimer

Avaya Inc. is not responsible for the contents or reliability of any linked Web sites referenced elsewhere within this documentation, and Avaya does not necessarily endorse the products, services, or information described or offered within them. We cannot guarantee that these links will work all of the time and we have no control over the availability of the linked pages.

Warranty

Avaya Inc. provides a limited warranty on this product. Refer to your sales agreement to establish the terms of the limited warranty. In addition, Avaya's standard warranty language, as well as information regarding support for this product, while under warranty, is available through the following Web site:

<http://www.avaya.com/support>

Copyright

Except where expressly stated otherwise, the Product is protected by copyright and other laws respecting proprietary rights. Unauthorized reproduction, transfer, and or use can be a criminal, as well as a civil, offense under the applicable law.

Avaya support

Avaya provides a telephone number for you to use to report problems or to ask questions about your product. The support telephone number is 1-800-242-2121 in the United States. For additional support telephone numbers, see the Avaya Web site:

<http://www.avaya.com/support>

Software License

USE OR INSTALLATION OF THE PRODUCT INDICATES THE END USER'S ACCEPTANCE OF THE TERMS SET FORTH HEREIN AND THE GENERAL LICENSE TERMS AVAILABLE ON THE AVAYA WEBSITE AT <http://support.avaya.com/LicenseInfo/> ("GENERAL LICENSE TERMS"). IF YOU DO NOT WISH TO BE BOUND BY THESE TERMS, YOU MUST RETURN THE PRODUCT(S) TO THE POINT OF PURCHASE WITHIN TEN (10) DAYS OF DELIVERY FOR A REFUND OR CREDIT.

Avaya grants End User a license within the scope of the license types described below. The applicable number of licenses and units of capacity for which the license is granted will be one (1), unless a different number of licenses or units of capacity is specified in the Documentation or other materials available to End User. "Designated Processor" means a single stand-alone computing device. "Server" means a Designated Processor that hosts a software application to be accessed by multiple users. "Software" means the computer programs in object code, originally licensed by Avaya and ultimately utilized by End User, whether as stand-alone Products or pre-installed on Hardware. "Hardware" means the standard hardware Products, originally sold by Avaya and ultimately utilized by End User.

License Type(s):

Designated System(s) License (DS). End User may install and use each copy of the Software on only one Designated Processor, unless a different number of Designated Processors is indicated in the Documentation or other materials available to End User. Avaya may require the Designated Processor(s) to be identified by type, serial number, feature key, location or other specific designation, or to be provided by End User to Avaya through electronic means established by Avaya specifically for this purpose.

Third-party Components

Certain software programs or portions thereof included in the Product may contain software distributed under third party agreements ("Third Party Components"), which may contain terms that expand or limit rights to use certain portions of the Product ("Third Party Terms"). Information identifying Third Party Components and the Third Party Terms that apply to them is available on Avaya's Web site at:

<http://support.avaya.com/ThirdPartyLicense/>

Interference

Using a cell, mobile, or GSM telephone, or a two-way radio in close proximity to an Avaya IP Telephone might cause interference.

Security

See <http://support.avaya.com/security> to locate and/or report known vulnerabilities in Avaya products. See <http://support.avaya.com> to locate the latest software patches and upgrades. For information about secure configuration of equipment and mitigation of toll fraud threats, see the Avaya Toll Fraud and Security Handbook at <http://support.avaya.com>.

Contents

| | |
|---|-----------|
| Important Safety Information | 9 |
| ATEX/IECEx Safety Instructions for 3749 Cordless Telephone | 10 |
| Sensitive Electronic Environment (EU/EFTA only) | 12 |
| Regulatory Compliance Statements (EU/EFTA only) | 12 |
| Always dispose of old equipment correctly - keep our environment tidy (EU/EFTA only) | 14 |
| Regulatory Compliance Statements (USA and Canada only). | 14 |
| Frequency Range | 16 |
| Power Supply | 16 |
| Safety Precautions. | 16 |
| Usage | 17 |
| Environmental Requirements. | 18 |
| Introduction | 21 |
| Functions and Accessories | 22 |
| Functions. | 22 |
| Accessories | 22 |
| Descriptions | 24 |
| The Avaya 3740/3749 Dect Telephone | 25 |
| Chargers | 26 |
| Desktop Charger. | 26 |
| Charging the telephone in Desktop charger | 27 |
| Rackmount Charger | 27 |
| Multiple Battery Charger | 27 |
| Icons and Text in the Display | 28 |
| Keys and Buttons | 32 |
| Off-hook Key | 32 |
| On-hook, and On/Off Key | 32 |
| Four-way Navigation Key | 32 |
| Voice mail Key | 32 |
| Sound off Key | 32 |
| Key Lock, and Upper/Lower Case Key | 33 |
| Soft keys | 33 |
| Hot keys | 33 |
| Multifunction/Alarm Button | 33 |
| Volume Button | 33 |
| Sound off button | 34 |
| Alphanumeric Keys | 34 |
| Accessories | 35 |
| Belt Clips | 35 |
| Leather Casing. | 35 |
| Headset. | 36 |

Contents

| | |
|---|-----------|
| Menu Tree | 37 |
| Calls | 37 |
| Contacts | 39 |
| Profiles | 40 |
| Messaging | 41 |
| My favourites | 42 |
| Short cuts | 42 |
| Connections | 43 |
| Settings | 44 |
| In Call | 45 |
| Customizing the Menu Tree | 46 |
| Basic Operation | 47 |
| Switch the Telephone On/Off | 47 |
| Turn the Audible Signal On/Off | 47 |
| Lock/Unlock the Keypad | 47 |
| Lock/Unlock the Keypad in Idle mode | 47 |
| Lock/Unlock the Keypad during a call | 48 |
| Lock/Unlock the Telephone | 48 |
| Calling | 49 |
| Incoming Call | 49 |
| Answer a Call | 49 |
| Decline a Call | 49 |
| End a Call | 49 |
| Outgoing Call | 50 |
| Dial a Number (Pre-Dial) | 50 |
| Dial a Number directly (Post-Dial) | 50 |
| Dial Using a Pre-programmed Hot key, Soft key or Multifunction button for 3740 phones | 50 |
| Dial using the Alarm button for 3749 telephones | 50 |
| Dial a Number from the Call list | 50 |
| Dial the sender of a Message | 51 |
| Dial a Number from the Local Phonebook | 51 |
| Dial a Name from the Central Phonebook | 51 |
| During a Call | 52 |
| Adjust the Volume during a Call | 52 |
| Open Contacts during the Call | 52 |
| Turn the Microphone on/off during a Call | 52 |
| Audio Transfer | 53 |
| Start a New Call during Conversation | 53 |
| Switch between Calls | 53 |
| End a Call | 53 |

| | |
|---|----|
| Transfer a Call | 54 |
| Transfer to new Call | 54 |
| Starting a Conference Call | 54 |
| Call Back | 54 |
| Call Waiting. | 55 |
| DTMF | 55 |
| Loudspeaking Function | 55 |
| Call Diversion | 56 |
| General Purpose | 56 |
| Messaging | 57 |
| Message List | 57 |
| Receive a Message | 57 |
| Send a Message | 57 |
| Write and Send a Message | 58 |
| Voice Mail | 58 |
| Receive a Voice Mail. | 58 |
| Check the Voice Mail inbox | 58 |
| One Key Voice Mail Access | 58 |
| Menu Operation | 59 |
| Connections | 59 |
| Bluetooth (3749 only) | 59 |
| Headset. | 59 |
| System | 60 |
| In Charger | 61 |
| Calls | 63 |
| Call List. | 63 |
| Missed Calls | 64 |
| Call Time | 64 |
| Call Services | 65 |
| Short Cuts | 66 |
| Define Soft Keys | 66 |
| Define Hot Keys | 66 |
| Define Navigation Key | 67 |
| Define Multi-function Button for 3740 telephones. | 67 |
| My favourites. | 67 |
| Add favourites | 68 |
| Edit favourites | 68 |
| Delete favourites. | 68 |
| Messaging | 68 |
| Inbox | 69 |

Contents

| | |
|---|----|
| Write New Messages | 70 |
| Unsent Messages | 70 |
| Sent Messages | 71 |
| Profiles | 72 |
| Contacts | 73 |
| Open personal phonebook | 73 |
| Call Contact | 73 |
| Add Contact | 73 |
| Edit Contact | 74 |
| Delete Contact | 74 |
| Central Phonebook | 75 |
| Settings. | 75 |
| Sound and Alert Settings | 75 |
| Phone Lock settings. | 77 |
| Display Settings | 78 |
| Time & Date Settings | 78 |
| Answering | 79 |
| Change Text size for Messages. | 80 |
| Change the Menu Language | 80 |
| Change Owner ID | 80 |
| Alarm Settings (for 3749 telephones). | 81 |
| Device info | 81 |
| Alarm Operations for 3749 telephones. | 82 |
| Push-Button Alarm | 82 |
| Test Alarm | 82 |
| Personal Alarm. | 82 |
| Man-Down and No-Movement Alarm | 83 |
| Acoustic Location Signal | 83 |
| Automatic Call after Alarm | 84 |
| Advanced Functions. | 85 |
| Procedure Call | 85 |
| Admin Menu | 86 |
| Clear Lists in Charger | 87 |
| System Handling. | 87 |
| Software Upgrade | 87 |
| Troubleshooting | 88 |
| Operation Notice. | 90 |
| Accessibility and Voice Quality. | 90 |
| Maintenance | 91 |
| Charge the Battery. | 91 |

| | |
|--|------------|
| Charge Spare Batteries | 91 |
| Replace the Battery | 91 |
| Attach the Hinge-type Clip | 92 |
| Attach the Swivel-type Clip | 93 |
| Attach Cover for No Clip | 93 |
| Bluetooth Headset for 3749 phones | 95 |
| Introduction | 95 |
| Wear | 95 |
| Headsets | 96 |
| Operation | 96 |
| Enable Bluetooth. | 96 |
| Pair and Connect a Bluetooth Headset. | 97 |
| Add another Bluetooth Headset | 97 |
| Select a Bluetooth Headset | 97 |
| Remove a Headset | 98 |
| Change the name of Bluetooth headset. | 98 |
| Calling | 98 |
| Make a Call | 98 |
| Answer a Call. | 98 |
| End a Call. | 99 |
| Volume/Mute Control | 99 |
| Adjust the Volume During a Call | 99 |
| Turn the Microphone On/Off During a Call. | 99 |
| Messaging | 99 |
| Transfer a call | 99 |
| Transfer a Call to the Telephone | 99 |
| Transfer a Call to the Bluetooth Headset. | 99 |
| Switch to a Headset with Cord | 100 |
| Menu Tree | 100 |
| Operation Notice. | 100 |
| Accessibility and Voice quality | 100 |
| Operation Area. | 100 |
| Out of Range | 100 |
| Environmental Requirements | 101 |
| Bluetooth Headset Battery | 101 |
| Troubleshooting | 101 |
| Quick Reference Guide | 103 |
| Index | 114 |

Contents

Important Safety Information

Read this chapter before using the Avaya 3740 DECT Telephone or Avaya 3749 DECT Telephone.

For safe and efficient operation of the telephone, observe the guidelines given in this manual and all necessary safety precautions when using the telephone. Follow the operating instructions and adhere to all warnings and safety precautions located on the product, the Quick Reference Guide and this User Manual.

This product shall only be used with the following batteries:

Avaya 3740 DECT Telephone:

No. 700500841: DECT 3740 HANDSET BATTERY PACK

Avaya 3749 DECT Telephone:

No. 700500842: DECT 3749 HANDSET BATTERY PACK

Chargers shall only be connected with power adapters included in the following charger kits:

Basic Charger:

No. 700479470: DECT 374x HANDSET BASIC CHARGER KIT EU

No. 700500871: DECT 374x HANDSET BASIC CHARGER KIT UK/NAR/AU

No. 700500872: DECT 374x HANDSET BASIC CHARGER KIT MEXICO

No. 700500873: DECT 374x HANDSET BASIC CHARGER KIT ARGENTINA

Advanced Charger:

No. 700479488: DECT 374x HANDSET ADV CHARGER KIT EU

No. 700500874: DECT 374x HANDSET ADV CHARGER KIT UK

No. 700500875: DECT 374x HANDSET ADV CHARGER KIT NAR

No. 700500876: DECT 374x HANDSET ADV CHARGER KIT AU

No. 700500877: DECT 374x HANDSET ADV CHARGER KIT BRASIL, MEXICO

No. 700500878: DECT 374x HANDSET ADV CHARGER KIT ARGENTINA

ATEX/IECEX Safety Instructions for 3749 Cordless Telephone

Intrinsically safe use

CE 0470



SIRA 10ATEX2072 IECEx SIR 10.0038
II 2G, II 2D Ex ib IIC T4 Gb Ex ib IIIC T55°C Db IP65
Tamb= -10° C to +40° C

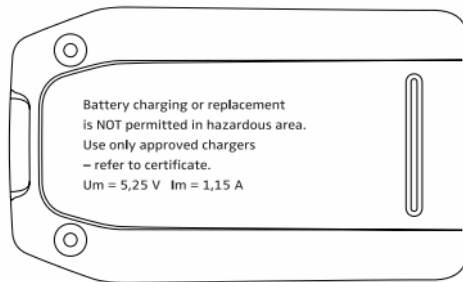

P/N: 660274/xx
Type: Li-ion Battery 3.7 V 920 mAh 3.4 Wh
Caution yyWww
DO NOT disassemble
DO NOT short external contacts
DO NOT expose to temperatures above 50°C or 122 °F
Only to be used with specified chargers
Dispose of Properly
S/N: xxxxxxx
Ascom (Sweden) AB,
Göteborg, SE-402 76, Sweden
Only to be used in DH5-xBxxxx

Charging the battery

When using in hazardous or classified areas, use an approved battery pack only. The battery pack must be marked with art. no 660274 on the label.

Charging parameters: $U_m = 5.25V$, $I_m = 1.15A$

For approved battery types, see certificate IECEx SIR 10.0038, or Sira 10ATEX2072 and following supplements.

The documents above and the EC Declaration of Conformity can be found at <http://www.avaya.com/gcm/emea/de/includedcontent/conformity.htm>.

Important:

Battery charging or replacement is NOT permitted in a hazardous area. When charging the EX classified handset, it is only permitted to use a charger marked with DC3-CAAB/1A (or greater), DC4-CAAB/3A (or greater) or CR3-CAAB/2A (or greater) on the label. It is not permitted to charge the EX battery pack alone.

Removal of the battery

The battery pack is fastened by two screws that require a special tool, Battery pack opener for the ATEX/IECEx/CSA battery. The opener is delivered together with the handset and can also be ordered as a spare part.

To remove the battery pack, use the opener and untighten the screws. Remove the battery pack by pulling the screws. To fasten the battery pack use the opener and tighten the screws. See also [Replace the Battery](#) on page 91.

Important:

Removing the battery pack is NOT permitted in a hazardous area.

Attention

- The product is housed in an enclosure that meets IP65. However, the ATEX/IECEx classified telephone is not intended to be immersed in dust or water.
- In the case of suspected damage, do not use the ATEX/IECEx classified telephone in a hazardous area.
- Make sure that the product marking corresponds to the site requirements.
- Before installation consult the product documentation.
- National safety rules and regulations have to be observed.
- Do not use accessories to the product without ensuring that they are suitable for use in a hazardous area.
- Modification of the product is not permitted.
- Product repair has to be done at authorised repair shops only.

Headset in ATEX/IECEx classified areas

In hazardous areas, it is only permitted to use the headset adapter for Peltor headset (art. no.: 660281) in combination with an ATEX/IECEx classified Peltor headset. The headset must be compatible with the output parameters of the headset connector as follows:

$U_o = 4.2 \text{ V}$
 $I_o = 169 \text{ mA}$
 $P_o = 583 \text{ mW}$
 $C_o = 2.2 \text{ }\mu\text{F}$
 $L_o = 2.2 \text{ }\mu\text{H}$

Sensitive Electronic Environment (EU/EFTA only)

Only use this product in countries where the appropriate authorities have given their authorisation.

The CE symbol on the product certifies its conformity with the technical guidelines concerning user safety and electro-magnetic compatibility valid at the time of approval; in accordance with European directive No. 1999/05/EC.



The products Avaya 374x DECT Telephones comply with IP65 according to IEC 529 / EN 60 529.

Any radio-based equipment can potentially cause interference with other equipment and can be interfered from other equipment. This also applies for DECT equipment. However due to the very low transmission power level the changes for interference are very small. Research proves that operational DECT telephones normally don't influence electronic equipment however some precautions must be taken into account for sensitive electronic equipment e.g. sensitive laboratory equipment. When DECT telephones operate in straight nearness of sensitive electronic equipment incidental influence can appear. You are advised not to place the DECT telephone on or close (less then 10 cm) to this kind of equipment, even in standby mode.

Regulatory Compliance Statements (EU/EFTA only)

Permission and Conformity

We, Avaya Inc., declare that the product line DECT R4 concurs with the basic requirements and other relevant provisions of EU Directive 1999/5/EU concerning radio equipment and telecommunications terminal equipment and the mutual recognition of their conformity.

Intended use

This equipment is intended for connection to radio interfaces (DECT) of Avaya PABX systems.

It is compliant with the essential requirements of the EU-Directive 1999/5/EU (Radio and Telecommunication Terminal Equipment, R&TTE).

Due to the differences of the individual public networks and network operators this compliance does not by itself give an unconditional assurance of successful operation at every network termination point. For the time being we are not aware of any network on which the equipment will not work due to its design.

In the event of problems, you should contact your equipment supplier or your Avaya service.

The conformity declaration can be accessed at the following Internet address:

<http://www.avaya.com/gcm/emea/de/includedcontent/conformity.htm>

or search the index using the key term "Conformity".

Always dispose of old equipment correctly - keep our environment tidy (EU/EFTA only)



Old electrical and electronic equipment marked with this symbol can contain substances hazardous to human beings and the environment. Never dispose of these items together with unsorted municipal waste (household waste). In order to protect the environment, public collection points have been set up to ensure the correct disposal of old electrical and electronic equipment marked with this symbol.

To reduce the risk of these substances being released into the environment and to reduce the burden on natural resources, it is also possible to participate in Avaya's used equipment return system. This system ensures the correct recycling of old equipment as well as the re-utilisation of individual components.

Regulatory Compliance Statements (USA and Canada only)

| Portables without Bluetooth | Portables with Bluetooth |
|-----------------------------|--------------------------|
| FCC ID:BXZDH5 | FCC ID:BXZDH5BL |
| IC: 3724B-DH5 | IC: 3724B-DH5BL |
| US: 9FVW4NANDH5 HAC | US: 9FVW4NANDH5 HAC |

FCC compliance statements

This equipment has been tested and found to comply with the limits for a Class B digital device, pursuant to part 15 of the FCC Rules. These limits are designed to provide reasonable protection against harmful interference in a residential installation. This equipment generates, uses and can radiate radio frequency energy and, if not installed and used in accordance with the instructions, may cause harmful interference to radio communications. However, there is no guarantee that interference will not occur in a particular installation. If this equipment does cause harmful interference to radio or television reception, which can be determined by turning the equipment off and on, the user is encouraged to try to correct the interference by one or more of the following measures:

- Reorient or relocate the receiving antenna.
- Increase the separation between the equipment and receiver.
- Connect the equipment into an outlet on a circuit different from that to which the receiver is connected.
- Consult the dealer or an experienced radio/TV technician for help.

Privacy of communications may not be ensured when using this cordless telephone.

Use of non-manufacture approved accessories may violate the FCC RF exposure guidelines and should be avoided.

Exposure to Radio Frequency Signals

This equipment complies with FCC radiation exposure limits set forth for an uncontrolled environment. This device complies with FCC SAR limit of 1.6 W/kg. The maximum SAR value measured when used at the ear, and when worn on the body using belt clip:

| SAR values | With Bluetooth | Without Bluetooth |
|-------------------|-----------------------|--------------------------|
| Head | 0.013 W/Kg | 0.008 W/Kg |
| Body worn | 0.016 W/Kg | 0.011 W/Kg |

This device and its antenna must not be co-located or operating in conjunction with any other antenna or transmitter.

Information to User

This device complies with Part 15 of the FCC Rules. Operation is subject to the following two conditions:

- (1) this device may not cause harmful interference, and
- (2) this device must accept any interference received, including interference that may cause undesired operation.

Modifications

Changes or modifications to the equipment not expressly approved by the party responsible for compliance could void the user's authority to operate the equipment.

Hearing Aid Compatibility

This equipment is hearing aid compatible (HAC).

IC Requirements for Canada

This Class B digital apparatus complies with Canadian ICES-003.
Cet appareil numérique de la Classe B conforme à la norme NMB-003 du Canada.

Frequency Range

The telephone is a radio transmitter and receiver. When it is on, it receives and sends out radio frequency (RF) energy. The telephone operates on different frequency ranges depending on market and employs commonly used modulation techniques:

| | |
|-----|---------------|
| EU | 1880-1900 MHz |
| USA | 1920-1930 MHz |
| LA | 1910-1930 MHz |
| BR | 1910-1920 MHz |

Power Supply

The mains voltage of the adapter should match the local mains voltage, this can be 110 V or 230 V. Check if both voltages do match before installing the charger and adapter.

Safety Precautions

- Do not open the cordless telephone or charger, this could expose you to high voltages. Have all repairs carried out by authorized service personnel.
- Avoid volume levels that may be harmful to your hearing. Exposure to excessive sound pressure from a telephone's earpiece or headset may cause permanent hearing loss.
- Do not allow the charger and the battery contacts to come into contact with conductive objects such as keys, paper clips, rings or bracelets.
- Do not allow the cordless telephone and charger to come into contact with water or chemicals.
- Only use the plug-in AC adapter and battery type supplied.
- Do not use AC adapters which are visibly damaged (cracked or broken housing) and keep the ventilation slits on the plug-in AC adapters free.
- Do not use the cordless telephones in vehicles or in hazardous locations.
- This product contains magnetic material. Be aware that small metallic objects may stick for example to the loudspeaker. This may deteriorate the audio quality and can be harmful.
- **Save this manual.** It includes important safety information and operating instructions. Save all instructions for future reference.

- Position the electrical cord to the AC power supply where it is least likely to be subjected to damage or stress.
- Remove the electrical cord from an outlet by pulling gently on the AC adapter, not by pulling the cord.
- Unplug the battery charger from a power source before cleaning the telephone to reduce risk of electric shock.
- Do not use auxiliary equipment with the telephone which is not exclusively recommended by the manufacturer, see [Accessories](#) on page 22. The use of any auxiliary equipment not recommended by the manufacturer may result in fire, electric shock, or injury, and will void the warranty.
- Do not expose the telephone to open flame.
- Do not expose the telephone and the charger to direct sunlight for long periods. Keep the telephone and charger away from excessive heat and moisture.
- Do not allow heavy objects to fall on the telephone.
- Do not allow children to play with the product packaging material. Product packaging material is often small and may present a choking hazard.
- Do not allow children to play with the telephone. It is not a toy. Children could hurt themselves or others. Children could also damage the telephone.
- Do not expose to prolong light.

Usage

Like all other cordless telephones, this cordless telephone uses radio signals which do not guarantee a connection set-up under all circumstances. Generally, you should therefore not rely exclusively on cordless telephones when making indispensable calls (for example, medical emergencies).

Environmental Requirements

Cordless Telephone

- Use the DECT cordless telephones within the following temperature ranges:
 - For 3740 telephone, from -10 °C to +55 °C (14 °F to 131 °F)
 - For 3749 telephone, from -10 °C to +40 °C (14 °F to 104 °F)
- Avoid exposing the telephone to direct sunlight or close to other heat sources.
- Do not expose the telephone to open flame.
- Keep the telephone away from excessive heat and moisture.
- Avoid sudden temperature changes to prevent condensation in the telephone. It is recommended to put the telephone into an air tight plastic bag until the temperature is adjusted, for example, when entering or leaving a cold/heated building on a warm/cold day.
- Protect your telephone from aggressive liquids and vapors.
- If the telephone has been exposed for water or condense, remove the battery immediately and let it dry completely before re-inserting the battery.
- Keep the telephone away from strong electromagnetic fields.
- Do not place a cold telephone in a charger.

Battery

- Do not immerse the battery into water. This could short-circuit and damage the battery.
- Do not expose a battery to an open flame. This could cause the battery to explode.
- Do not allow the metal contacts on the battery to touch another metal object. This could short-circuit and damage the battery.
- Do not leave a battery where it could be subjected to extremely high temperatures, such as inside a car on a hot day.
- Use the Desktop Charger or the wall mounted Charging Rack for charging. Charge the battery for at least one hour the first time you use the battery. Note that the wall mounted charger with a battery pack adapter has to be used if the battery alone is to be charged.
- Do not charge a battery when the ambient room temperature is above 40 °C or below +5 °C (above 104 °F or below 41 °F).
- Do not attempt to take a battery apart.
- Do not disconnect the battery unless it needs to be replaced.
- Do power the telephone off before removing the battery.

Chemical Resistance

The alpha and numeric characters printed on the exterior of the telephone have been tested and found resistant to chipping, fading or wearing off when the telephone is treated with common cleaners and disinfectants or perspiration. The following chemicals have shown no harmful effect:

- 3% Hydrochloric Acid
- M-alcohol (85% Methylated Ethanol)
- 60% Chlorhexidin 0.5 mg/ml

Acetone can be damaging to the plastic casing of the telephone and should not be used.

Introduction

This document describes features and settings available for the Avaya 3740 and 3749 DECT Telephone. The cordless telephone is a feature-rich telephone with colour display, telephony, messaging, illuminated monochrome or colour display, bluetooth (3749 only) and alarm functions for personal security (3749 only). The telephones are highly robust designed to be used in demanding environment, for example the industry.

It is suitable for users dependent of being reachable and/or having a need for mobile voice and messaging features, which makes it ideal for applications where the user needs either one way messaging or to be able to interact with other users. In addition, the alarm functionalities on the 3749 increase the safety for isolated-workers and the colour display enhances and simplifies the use of the cordless telephones.

Read the [Important Safety Information](#) on page 9 before using the telephone.

For software download and parameter set up, read the *Installation and Administration Manual, DECT R4*.

Quick Reference Guide

To get a quick overview on the basic functions of your telephone, see [Quick Reference Guide](#) on page 103. Because of its handy format you can place a print-out next to your telephone as a quick reference.

Functions and Accessories

Functions

- Local phonebook with 250 user editable entries
- Central phonebook
- Company phonebook with 1000 non-editable entries
- Vibrator
- Headset connector
- Microphone on/off during call
- Loudspeaking function
- Short message service (SMS)
- Voice mail access
- Centralized Management
- Easy Access to PBX functions
- Procedure call
- Telephone restrictions
- Call list
- Easy replaceable battery for 3740 telephones
- Keypad backlight for 3740 telephones
- Programmable multifunction key for 3740 telephones
- Bluetooth for 3749 telephones
- Alarming for 3749 telephones: alarming button, man down alarm, and no movement alarm

Note:

Use of the functions Central phonebook, SMS, Voice mail access, Call list, and Centralized Management are system dependent.

Accessories

- Basic Charger
- Advanced Charger
- Rackmount Charger
- Multiple Battery Charger for 3740 telephones

- Battery Pack
- Leather case
- Belt Clip
 - hinge-type
 - swivel-type
- Headset with microphone on boom
- Headset adapter for Mic on boom
- Peltor hearing protection headset
- Headset industry
- Headset adapter industry and atex
- Handset 3749 battery pack opener

Descriptions

Figure 1: Description of the cordless telephone.

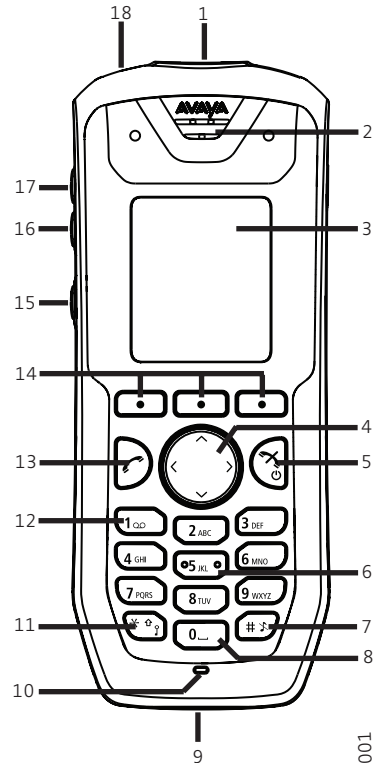

- | | |
|--|---|
| <p>1. Multifunction/Alarm button The button is placed on the top side of the cordless telephone. On 3740, this button can be used as a shortcut to functions. It supports long and double press modes. On 3749, it can be used as an alarm button.</p> <p>2. Earpiece speaker</p> <p>3. Display The full graphic type display is 128 pixels wide and 160 pixels high. For 3749, the display has multiple colors and backlighting. For 3740, the display is monochrome black and white, with backlighting.</p> | <p>10. Microphone The microphone is placed on the front bottom side of the cordless telephone.</p> <p>11. Key lock and Upper/Lower case This key is to lock the keypad in combination with the Soft key "Lock". This key is also for switching between upper/lower case and digits.</p> <p>12. Voice mail access A quick access to the telephone's Voice mail.</p> |
|--|---|

- | | |
|--|--|
| <p>4. Four-way navigation key Navigation key with Left, Right, Up, Down. Use this key to step in the menu and when working in text mode. It is also possible to program these keys for shortcuts.</p> <p>5. On-hook; On/Off key Combined button; to end a call, to return to idle mode, and to switch the telephone on/off by long press.</p> <p>6. Tactile indicators There are two tactile indicators to indicate the centre of the keypad.</p> <p>7. and 15. Sound off key/Mute button To turn on/off audible signals in idle mode, silencing the ring signal at incoming call and to mute in call.</p> <p>8. Space To add space between text.</p> <p>9. Multi-purpose connector The connector is used for battery charging, software download, configuration, and connection of headset.</p> | <p>13. Off-hook key To answer a call, to pre-dial a number, and to post-dial</p> <p>14. Soft keys The three Soft keys are located just beneath the display and the function of each Soft key is indicated by text in the display just above the keys. In idle mode, the middle and right Soft key can be used for specific functions defined by the user of the telephone.</p> <p>15. and 7. Sound off key/Mute button</p> <p>16. Volume down To decrease the speaker volume.</p> <p>17. Volume up To increase the speaker volume.</p> <p>18. LED Indicates incoming call, messaging, low battery, and charging.</p> |
|--|--|

The Avaya 3740/3749 Dect Telephone



Important:

The telephone may retain small magnetic objects around the microphone or the speaker region.

Case

The plastic cover parts are made of durable PC/ABS material.

Antenna

The antenna is integrated inside the cordless telephone.

Loudspeaker

The cordless telephone has a separate loudspeaker for the loudspeaking function. It is placed on the back side of the cordless telephone.

Microphone

The microphone is placed on the front bottom side of the cordless telephone.

Clip

There are three different belt clip options to the cordless telephone; a hinge-type clip (standard), a swivel-type clip, or no clip which makes it possible to use the cordless telephone without any clip on. See [Attach the Hinge-type Clip](#) on page 92, or [Attach the Swivel-type Clip](#) on page 93. Use the clip to attach the telephone to a belt or similar.

Battery

The battery is a rechargeable Li-ion battery, placed under a battery cover. See [Replace the Battery](#) on page 91.

The battery is fully charged within four hours. See [Charge the Battery](#) on page 91.

The battery of the 3740 telephone can be charged separately with a special Multiple Battery Charger. See [Charge Spare Batteries](#) on page 91

Chargers

Desktop Charger

Figure 2: Desktop chargers

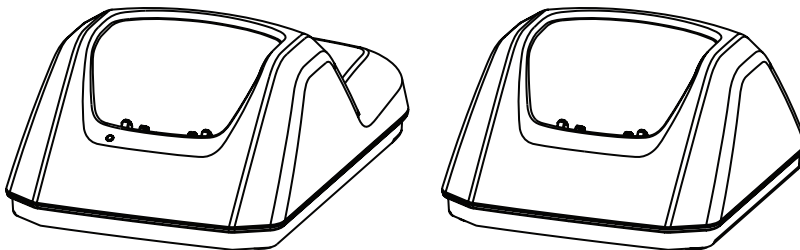

Advanced

Basic

There are two desktop chargers available, one Basic charger that will only charge the cordless telephone, and one Advanced Charger with advanced functionality to download new software and synchronize parameters. The cordless telephone is fully operational while placed in the charger.

The Basic Charger is delivered with a plug-in power supply and is connected into an ordinary wall socket. The Advanced Charger is delivered with a power supply adapter. The adapter is connected with a power cord to the wall socket and the Charger itself is supplied from the adapter.

⚠ Important:

For 3749 telephones, battery charging or replacement is NOT permitted in a hazardous area.

For more information, see *Installation and Administration Manual, DECT R4*.

Note:

Only use the charger within the temperature range of +5 °C – +40 °C (+41 °F – +104 °F).

⚠ Important:

Only use the provided power supply, see *Installation and Administration Manual, DECT R4*.

Charging the telephone in Desktop charger

When the charger is connected to external power supply, normal operation is done as follows:

Telephone charging

1. Place a cordless telephone in the charging slot to start charging.

Telephone disconnection

1. First, tilt the telephone forwards.
2. Then, lift the telephone upwards.

Note:

Do not try to lift the telephone upwards before tilting it forwards.

Rackmount Charger

The Rackmount Charger is used for charging several telephones, to synchronize parameters, and for software download.

The built in power supply can charge up to six cordless telephones.

See *Installation and Administration Manual, DECT R4*.

Multiple Battery Charger

The Multiple Battery Charger is used for charging up to six spare batteries.

Icons and Text in the Display

All functions and settings available to the user are shown as icons and text in the display. The icons and text in the display indicate functions and settings to which you have access. The display normally displays date and time, the Owner ID and telephone number. The Owner ID can manually be set by the user.

Figure 3: Example of a display configuration in idle mode

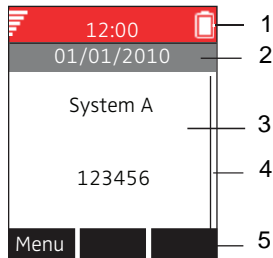

Figure notes:

- | | |
|----------------|-----------------|
| 1. Status bar | 4. Scroll bar |
| 2. Header bar | 5. Soft key bar |
| 3. Active area | |

The top row (**Status bar**) is used for icons which give the user information for signal strength, missed call, new message, phone lock, key lock, sound off, time and battery status. This row is always visible in all screens.

The next row (**Header bar**) displays the current date, headset connection, Bluetooth connection, and system connection.

The next rows (**Active area**) are used for information such as, profiles, the name of the system to which the cordless telephone is connected to. A user identity provided from the system and/or an Owner ID can also be displayed if configured in the Settings menu. This is also the area for pop up text for example, missed calls or to confirm an action.

The bottom row (**Soft key bar**) is used for Soft keys which can be used as short cuts for functions in the telephone. See [Soft keys](#) on page 33.

The (**Scroll bar**) is placed to the right side of the active area. It becomes visible when a menu screen has more than six menus, or if there are more than four rows of message text in a message.

Note:

For 3740 DECT telephones, the display is monochrome black and white, with backlighting.

Icons



Signal strength icon is visible in the upper left corner. The bars shown in display depends on the signal strength.



Full battery icon is displayed in upper right corner.



Low battery icon is shown when the battery only has 5% of its capacity left. The icon is flashing when the battery capacity is equal to, or lower, than 5%.



Sound off icon is displayed when the Sound off key is pressed or if the telephone has the In charger > Sound off option enabled.



Ring volume silent icon is displayed when the volume is set to silent.



Microphone off icon indicates a silenced microphone. It is displayed after a long press on the Sound off key during a call.



Loudspeaking icon is displayed in the Soft key bar during a call. Pressing this icon will activate the loudspeaking mode.



Loudspeaking off icon is displayed after the Soft key for Loudspeaking icon has been pressed. Pressing this icon will deactivate the loudspeaking mode.



New message icon indicates that a new text message (or messages) has arrived. The icon remains in the status bar until all new messages in the inbox are read.



Voice mail message icon is displayed in the inbox when there are voice mails. The icon remains until voice mail has been listened.



Read message icon in front of a message shows that this message once has been read.



Sent message icon



Unsent message icon



Key lock icon indicates a locked keypad.



Phone lock icon indicates a locked telephone.



Bluetooth icon indicates that Bluetooth is enabled (only for 3749 phones).



Bluetooth headset icon indicates that a Bluetooth headset is connected to the telephone (only for 3749 phones).



Headset icon indicates that a corded headset is connected to the telephone.



Outgoing call icon is added to all outgoing calls in the call list.



Incoming call icon is added to all answered calls in the call list.



Missed call icon is added to all missed calls in the call list, and in the status bar.



System connection icon is visible when connected to an administration system.



Profile active icon



Man-down icon (only for 3749 telephones)



No-movement icon (only for 3749 telephones)

Menu icons



The **Contacts** menu contains all names/numbers in the personal phonebook. It is also possible to access a central phonebook from this menu.



The **My favourites** menu contains menu short cuts used to customize an own menu.



The **Messaging** menu contains all message handling such as reading and writing messages.



The **Calls** menu contains call lists, call time, and call services¹. Call services is configured in the PDM or AIWS.



The **Connections** menu contains Bluetooth connection, headset selection, System selection, and In charger selection.



The **Settings** menu contains personal telephone settings such as changing the ringer volume, selecting language, etc.



The **Short cuts** menu contains short cuts for the Soft keys, Hot keys, Navigation keys, and the Multifunction button.



The **Profiles** menu contains possibility to add four different profiles. By default there is no profile.

1. System dependent

Note:

For 3740 DECT telephones, the icons are in monochrome black and white.

Keys and Buttons

Off-hook Key



This key is used for connecting calls. This key can be programmed in the PDM/AIWS, it is by default set as Post-dial.

On-hook, and On/Off Key



This key is used for disconnecting calls and returning to main screen.

A long press in idle mode will switch the telephone on/off.

Four-way Navigation Key



Use this four-way navigation key to step in the menu and when working in text mode.

←, →, ▲, and ▼ are used for stepping left/right and up/down in the menu. The navigation key can be programmed. The ▲ is by default a shortcut to the Inbox, and ▼ is a shortcut to Call contact. During a call, it is possible to increase/decrease the volume by pressing ▲ and ▼.

Voice mail Key



A long press on this key gives a quick access to the telephone's Voice mail.

Sound off Key



This key is to silence or mute the telephone. It works like the [Sound off button](#) on page 34.

Key Lock, and Upper/Lower Case Key



This key is to lock or unlock the keypad in combination with the Soft key **Lock**. It is also for switching between upper/lower case and digits.

Soft keys

Figure 4: Soft keys.

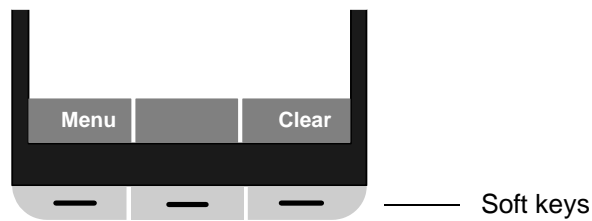

The three Soft keys are located just beneath the display and the functions of each Soft key is indicated by text in the display just above the keys.

In idle mode the Soft keys can be used for specific functions defined by the user of the telephone.

Hot keys

A Hot key can be programmed to give access to frequently used functions such as dialling a specific telephone number, a shortcut on the menu, or sending an SMS. Any key **0, 2 - 9** can be set to a Hot Key. A long press on any of these digits in stand by mode are by default a shortcut to the Call contact list.

Multifunction/Alarm Button

The button is placed on the top side of the cordless telephone. On 3740, this button can be used as a shortcut to functions. It supports long and double press modes. It is by default not used, but can be defined by the user of the telephone. On 3749, it is used as an alarm button.

Volume Button

The two buttons placed on the upper left side of the cordless telephone are used for increasing/decreasing the earpiece, headset, and the loudspeaker volume.

Sound off button

The button is placed on the left side of the cordless telephone, next to the screen.

- While in a call a press on the button will mute the microphone.
- When the telephone is ringing a short press switches off the ringing tone temporarily.
- In idle mode a long press will silence the telephone.

Alphanumeric Keys

| Key | Capital letter | Small letter |
|-----|-----------------|-------------------|
| 1 | . , ? ! - ' " 1 | . , ? ! - ' " 1 |
| 2 | A B C À Â Æ Ç 2 | a b c æ à â æ ç 2 |
| 3 | D E F È É Ê Ë 3 | d e f è é ê ë 3 |
| 4 | G H I Î Ï 4 | g h i î ï 4 |
| 5 | J K L 5 | j k l 5 |
| 6 | M N O Ñ Ô Ö Æ 6 | m n o ñ ô ö æ 6 |
| 7 | P Q R S 7 | p q r s 7 |
| 8 | T U V Û 8 | t u v û 8 |
| 9 | W X Y Z 9 | w x y z 9 |
| 0 | Space + * 0 | Space + * 0 |
| * | * | * |
| # | # | # |

Note:

Depending on the selected menu language and input language, other characters can be available. This means that the character order can differ from the table above.

In idle mode, and number input mode

- A short press on a key enter the digits 0 - 9 and the characters * and #.
- Enter a pause in number input mode by a long press on the #-key. A pause is indicated by a **P** in the display.

- A long press on the *- key changes the tone sender on. Tone sender on is indicated by a **T** in the display.

In text input mode

- A short press on a key **0 - 9**, displays the first available character on that specific key. The marked character is selected after a timeout, or when another key is pressed.
- To change to upper/lower case, press the *-key before entering the character. The *-key can also be used to display only the digits.
- To add space in the text, make a short press on key **0**.
- The first character entered in a message, or when adding/editing a name in the Contacts menu, will be an upper level character followed by lower level characters, unless the *-key is pressed before entering the character. To switch between Abc, ABC, abc, and 123 the *-key is pressed.
- A long press on the key **#** displays special characters.
- To delete a character, position the prompt right from the character to delete and press Soft key **Clear**.

Accessories

Belt Clips

Three belt clip options are available:

- Hinge-type clip
To prevent the telephone from slipping out of for example pocket or belt
- Swivel-type clip
To be able to rotate without slipping out from the case
- No clip
To be able to use the telephone without a clip
To be able to use the telephone without a clip, a cover plate without a clip is also available.

Leather Casing

The leather casing is especially designed for the telephone. The casing comes with a swivel type belt clip and the telephone is fully operational while placed in the casing.

Headset

Headsets are available with specific connectors if you frequently use the telephone and/or want to have both hands free.

You can order a headset adapter for Peltor headset with the telephone.



Important:

In hazardous areas, you are permitted to use only the headset adapter for Peltor headset in combination with an ATEX/IECEX classified Peltor headset.

In order to achieve optimal audio quality with different headset types, Avaya recommends selecting the corresponding headset profile.

The default setting is microphone on a boom, that is, the audio is optimized for using a headset with microphone on a boom. The headset profile can be changed in the **Connections** menu.

If the preconfigured headset profiles do not match the headset in use, or the audio performance needs to be optimized for a certain environment or user, it is possible to configure your own headset profile. This is done in the PDM. See *Installation and Administration Manual, DECT R4*. If a customized headset profile is configured in the PDM, it is selectable in the telephone menu.

Menu Tree

Note:

In order to continuously improve the comprehensibility of menu terms, some of them in your telephone may differ from those used in the following menu trees.

Calls

| | | | | | |
|--------------|---|--|---|--------|----------------|
| Call list | > | 7891 01:30 7845 20-Oct-08 ... | > | ● Call | |
| | | | | ● More | > Time of call |
| | | | | | Edit number |
| | | | | | Save number |
| | | | | | Send message |
| | | | | | Delete |
| | | | | | Delete all |
| | | | | ● Back | |
| Missed calls | > | 7682 05:26 7845 23-Sep-08 | > | ● Call | |
| | | | | ● More | > Time of call |
| | | | | | Edit number |
| | | | | | Save number |
| | | | | | Send message |
| | | | | | Delete |
| | | | | | Delete all |
| | | | | ● Back | |

| | | | | | | |
|---------------|---|---|---|-----------|--|--|
| Call time | > | Total time 03:47:06 Last call 00:00:07 | | | | |
| Call services | > | Divert calls ¹ | > | Internal | | |
| | | | | External | | |
| | | | | No reply | | |
| | | | | When busy | | |
| | | General purpose 1 Name ¹ - General purpose 16 Name ¹ | | | | |

1. Visible if defined in PDM or AIWS.

Contacts

| | | | | | |
|--------------------------------|---|---------------------|---|---------------|-----------------|
| Call contact | > | Search | | | |
| | | <From contact list> | | | |
| Add contact | > | New | > | Name | |
| | | | | Work number | |
| | | | | Mobile number | |
| | | | | Other number | |
| | | | | Ring signal | |
| | | From call list | | | |
| Edit contact | > | Search | | Back | |
| | | <From contact list> | | Name | |
| | | | | Work number | > |
| | | | | Mobile number | |
| | | | | Other number | |
| | | | | Ring signal | |
| Delete contact | > | Search | | | |
| | | <From contact list> | | | |
| Central phonebook ¹ | > | Search by name | > | ● Call | |
| | | Search by number | > | ● More | > View contact |
| | | Last result | > | | Add to contacts |
| | | | | | Send message |
| | | | | ● Back | |

1. System dependent

Profiles

| | | | | | |
|------------------|---|------------------|---|---------------|-----------------|
| Normal (example) | > | <Name> | | | |
| | | Volume | | | |
| | | Ring signals | > | Internal call | > <Ring signal> |
| | | | | External call | > <Ring signal> |
| | | | | Call back | > <Ring signal> |
| | | Message alert | > | <Ring signal> | |
| | | Vibrating alert | > | On | |
| | | | | Off | |
| | | | | On if silent | |
| | | Key sound | > | Click | |
| | | | | Tone | |
| | | | | Silent | |
| | | Answer behaviour | > | Automatically | |
| | | | | Loudspeaking | |
| Add new | | | | | |

Messaging

| | | | | | | | | |
|-------------------|---|--------------|---|--------|---|------------|---|------------------|
| Inbox | > | Message List | > | ● View | > | ● Reply | > | Enter text |
| | | | | | | ● More | > | Delete |
| | | | | | | | | Forward |
| | | | | | | | | Call sender |
| | | | | | | | | Call no. in text |
| | | | | | | | | Save number |
| | | | | | | ● Close | | |
| | | | | ● More | > | Delete | | |
| | | | | | | Delete all | | |
| | | | | ● Back | | | | |
| Write new message | > | Enter Text | | | | | | |
| Unsent | > | Message List | > | ● Edit | > | ● Send | > | Enter number |
| | | | | | | ● Clear | | |
| | | | | | | ● Back | | |
| | | | | ● More | > | Delete | | |
| | | | | | | Delete all | | |
| | | | | ● Back | | | | |
| Sent | > | Message List | > | ● View | > | ● Forward | > | Enter text |
| | | | | | | ● More | > | Delete |
| | | | | | | | | Call no. in text |
| | | | | | | | | Save number |
| | | | | | | ● Close | | |
| | | | | ● More | > | Delete | | |
| | | | | | | Delete all | | |
| | | | | ● Back | | | | |

My favourites



| | | | | | | |
|---------|---|----------|---|--------------|--|--|
| Add new | > | Name | > | Phone call | | |
| | | | | Send message | | |
| <Name> | | ● Select | | | | |
| | | ● More | | Edit | | |
| | | | | Delete | | |
| | | ● Back | | | | |

Short cuts



| | | | | | | |
|-----------|---|----------|---|------------------|---|-------------------|
| Soft keys | > | Left | > | Name | | |
| | | | | Function | > | Not used |
| | | | | | | Phone call |
| | | | | | | Contact list |
| | | | | | | Central phonebook |
| | | | | | | Message inbox |
| | | | | | | Send message |
| | | | | | | Change profile |
| | | | | | | Open a menu |
| | | | | | | Call absence |
| | | | | Value | | |
| | | | | Control question | | |
| | | Middle | | | | |
| | | Right | | | | |
| Hot keys | > | 0, 2 - 9 | > | Function | > | (same as above) |
| | | | | Value | | |

| | | | | | |
|--|---|-------------|---|------------------|-------------------|
| | | | | Control question | |
| Navigation keys | > | Up | > | Function | > (same as above) |
| | | Down | | Value | |
| | | Left | | Control question | |
| | | Right | | | |
| Multifunction button (for 3740 telephones) | > | Long press | > | Function | > (same as above) |
| | | Multi press | | Value | |
| | | | | Control question | |

Connections



| | | | | | |
|------------------------------------|---|---------------------------|---|--------------|--|
| Bluetooth (for 3749 telephones) | > | Enable / Disable | | | |
| | | Headset | > | Add new | |
| Headset | > | Mic on boom | | | |
| | | Hearing protection | | | |
| | | <user headset profile> | | | |
| System | > | Change system | | | |
| | | Subscribe | | | |
| | | Unsubscribe | | | |
| | | Rename system | | | |
| | | Priority | | | |
| In charger | > | Call behavior | > | No action | |
| | | | | Loudspeaking | |
| | | | | End call | |
| | | Other actions | > | No action | |
| | | | | Switch off | |

| | | | | | | |
|--|--|--|--|-----------|--|--|
| | | | | Redirect | | |
| | | | | Sound off | | |

Settings

| | | | | | |
|-----------------|---|--------------------|---|-----------------|---------------|
| Sounds & Alerts | > | Volume | | | |
| | | Ring signals | | | |
| | | Message alert | | | |
| | | Vibrator alert | | | |
| | | Key sound | | | |
| Locks | > | Automatic key lock | > | On | |
| | | | | Off | |
| | | Phone lock | > | Auto phone lock | > On |
| | | | | | On in charger |
| | | | | | Off |
| | | | | Change PIN code | |
| Display | > | Brightness | > | Normal | |
| | | | | Screen saver | |
| | | Screen saver | > | Information | |
| | | | | Black | |
| | | Contrast | | | |
| Time & Date | > | Time format | | | |
| | | Date format | | | |
| Answering | > | Answering key | > | Hook-off | |
| | | | | Any key | |
| | | Answering behavior | > | Automatically | |
| | | | | Loudspeaking | |
| Messages | > | Text size | | | |

| | | | | | |
|-----------------------------|---|---------------------------------|---|-------------|--|
| *Language | > | Dansk, Nederlands, English, ... | | | |
| Owner ID | | | | | |
| Alarm (for 3749 telephones) | > | Activate alarm | > | Man-down | |
| | | | | No-movement | |
| Device info | > | Software | | | |
| | | Hardware | | | |
| | | IPEI | | | |
| | | User ID | | | |

In Call

The In Call menu can be reached during an ongoing call by pressing the middle Soft Key marked **More**.

Note:

If configured in the PDM/WSM, it is possible to make an emergency call while the telephone or keypad is locked. During the ongoing emergency call, it is only possible to access the Microphone on/off function in the **In Call** menu.

| | | | | | |
|-----------------------------------|---|--------------------|--|--|--|
| Contacts ² | | | | | |
| Microphone on/off | | | | | |
| Audio transfer ¹ | | | | | |
| New call ² | > | Call | | | |
| | | "Phonebook access" | | | |
| | | Cancel | | | |
| Switch ² | | | | | |
| End call ² | | | | | |
| Transfer ² | | | | | |
| Transfer to new call ² | > | Call | | | |
| | | "Phonebook access" | | | |

| | | | | | | |
|---|---|-----------------|--|--|--|--|
| | | Cancel | | | | |
| Conference ² | | | | | | |
| Call back ² | | | | | | |
| Call waiting ² | | | | | | |
| DTMF | | | | | | |
| DECT info ³ | > | Link | | | | |
| | | System | | | | |
| | | Encryption mode | | | | |
| General purpose 1 Name ² - General purpose 10 Name ² | | | | | | |

1. Only available when the Bluetooth connection is active.
2. Visible if defined in the PDM or AIWS.
3. Visible if the Admin menu is activated.

Customizing the Menu Tree

The menu tree can be customized by hiding some of the functions that are available but for example not in use. Which functions that should be hidden are defined in the PDM or AIWS. See *Installation and Administration Manual, DECT R4*.

Basic Operation

Switch the Telephone On/Off

The telephone is switched off:

1. Press and hold **On-hook** key.
The telephone will vibrate when it is on and the display lights up.

The telephone is in idle mode:

1. Press **On-hook** key long.
A control question will be displayed.
2. Confirm with Soft key **Yes**.

Note:

The telephone returns to idle mode when pressing the **On-hook** key while in a menu.

Turn the Audible Signal On/Off

Note:

If the parameter **Disable permanent mute** is enabled, the user cannot turn off the audible signal. See *Installation and Administration Manual, DECT R4*.

Your telephone is in idle mode or rings.

1. Press the **Sound off** button long. The status of the telephone changes between ring signal on/off. To locate the button, see [Descriptions](#) on page 24.

The  icon indicates a silenced telephone.

Lock/Unlock the Keypad

Lock/Unlock the Keypad in Idle mode

To prevent accidentally pressing keys and making a call, the keys can be locked.

Lock keypad

1. Press the * key.
2. Press the Soft key **Lock**.

Unlock keypad

1. Press the * key.
2. Press the Soft key **Yes**.

Note:

It is possible to answer/close an incoming call while the keypad is locked.

Note:

You can activate an automatic key lock. The keypad will be locked automatically a short time after the last keystroke. See [Activate the Automatic Key Lock](#) on page 77.

Note:

While placed in charger, a telephone's keypad is always unlocked.

Lock/Unlock the Keypad during a call

To prevent accidentally pressing keys, the keys can be locked during a call. This can be useful when a headset is used and the handset is attached to a pocket or belt.

Lock Keypad

1. Longpress the * key.
2. Press the Soft key **Lock**.

Unlock Keypad

1. Press the * key.
2. Press the Soft key **Yes**.

Lock/Unlock the Telephone

The telephone can be protected for unauthorized use. If this function is activated it locks automatically a short time after the last keystroke or when placed in the charger. A PIN code is required for unlocking the telephone. For more information see [Phone Lock settings](#) on page 77.

Unlocking the telephone

The phone shows the text "Turn off phone lock?"

1. Press Soft key **Yes**.
2. Enter PIN code
3. Press Soft key **OK**.

Calling

Incoming Call

The flashing LED, accompanied by a ring signal and/or a vibrating telephone, give you notice of a call. Ring signal and vibrator can be disabled. The handset will ring in the connected headset even if the handset is set to silent or the ringer volume level is set to silent. The calling party's telephone number or name is shown. The name will be shown if the calling party's telephone number is stored in the local phonebook. Press the **Off-hook** key to answer the call. When a headset is connected to the telephone, the answering button on the headset can be used to answer the call.

Other answering methods can also be set in the **Settings** menu, see [Settings](#) on page 44. The answering methods are **Automatically** and **Loudspeaking**.

Answer a Call

Your telephone rings.

1. Press **Off-hook** key or press the Soft key  to answer the call in loudspeaking mode.

Decline a Call

Your telephone rings.

1. Press **On-hook** key to decline the call.

Note:

A priority call cannot be declined.

End a Call

1. Press **On-hook** key to end the call.
The duration of the call is shown in the display.

Note:

The total time of the call can also be retrieved from the menu **Calls > Call time**.

Outgoing Call

Dial a Number (Pre-Dial)

1. Enter the number.
2. If needed, you can press the Soft key **Clear** to erase the last entered digit. By using the navigation key ◀▶ it is possible to step and add/delete a digit in the middle of a number.
3. Press **Off-hook** key to get the line. The number is shown on the display while dialling.

Note:

It is possible to turn on/off the tone sender in a post-dialled number by making a long press on the *-key.

Dial a Number directly (Post-Dial)

1. Press **Off-hook** key to get the line.
2. Enter the number. Each entered digit is dialled immediately. However, in this case you will not be able to correct an input error.

Note:

The number will not be added to the call list when pre-dial is used.

Dial Using a Pre-programmed Hot key, Soft key or Multifunction button for 3740 phones

A Hot key, Soft key or Multifunction button can be programmed with a telephone number. Press the pre-programmed Hot key, Soft key or multifunction button to dial the number. The call will automatically be connected.

Dial using the Alarm button for 3749 telephones

A 3749 telephone can be configured to call a predefined number when an alarm has been sent. If configured, it is also possible to call the predefined number without sending an alarm by pressing the Alarm button. Depending on the settings, the call can be established in the following modes:

- Loudspeaking mode
- Normal mode

Dial a Number from the Call list

1. Open the menu by pressing the confirmation button, or the Soft key **Menu**.

2. Select **Calls**.
3. Select **Call list**,
4. Step with the ▲ and ▼ to scroll in the list. Select number to call.
5. Press Soft key **Call** to dial.

Dial the sender of a Message

You can call the sender of a message stored in the message list, from the Messaging menu.

1. Open the menu by pressing the confirmation button, or the Soft key **Menu**.
2. Select **Messaging**.
3. Select **Inbox**.
4. Select number from the list.
5. Select **View**.
6. Select **More**.
7. Select **Call sender**.

Dial a Number from the Local Phonebook

1. Open the menu by pressing the confirmation button, or the Soft key **Menu**.
2. Select **Contacts**.
3. Select **Call contact**.
4. Select contact from list, or search name by entering characters.
The best matching entry will be automatically selected.
5. Press Soft key **Call** or the **Off-hook** key to make the call.

Dial a Name from the Central Phonebook

1. Open the menu by pressing the confirmation button, or the Soft key **Menu**.
2. Select **Contacts**.
3. Select **Central phonebook**.
4. Select **Search by name**.
5. Enter the first name and/or last name, the whole name does not have to be entered.
6. Press **Search**.
7. Press Soft key **Call** or **Off-hook** key to make the call.

During a Call

Note:

Some of these functions are system dependent and are not shown in the menu. They are set up by your system administrator in the PDM or AIWS, see *Installation and Administration Manual, DECT R4*. If applicable, additional functions could be programmed by your system administrator.

If configured in the PDM/AIWS, it is possible to call an emergency number while the telephone is locked. During the ongoing emergency call, you can only turn the microphone on or off by pressing the soft key **More**. In addition, the right soft key is also disabled, unless it is not configured as the **Loudspeaker** soft key.

Adjust the Volume during a Call

1. Press the **Volume up** button to increase the volume, and the **Volume down** button to decrease the volume.
The telephone will now store and keep the new volume level.

Note:

It is also possible to use the navigation key, ▲ and ▼ to adjust the volume.

Open Contacts during the Call

1. Press Soft key **More**.
2. Select **Contacts**.
3. Press Soft key **Select**.
4. See [Contacts](#) on page 73.

Turn the Microphone on/off during a Call

1. Press the Soft key **More**.
2. Select **Microphone off**.
3. Press Soft key **Select**.

The  indicate a silenced microphone. This means that the other part in an ongoing call cannot hear you.

Turn the microphone back on:

1. Press Soft key **More**.
2. Select **Microphone on**.

3. Press **Select**.

Note:

It also possible to turn the microphone off/on by a long press on the **Sound off** button, see [Descriptions](#) on page 24.

Audio Transfer

To transfer audio between the Bluetooth headset and the telephone's earpiece during the call.

1. Press Soft key **More**.
2. Select **Audio transfer**.
3. Press Soft key **Select**.

Note:

Audio transfer is visible if Bluetooth connection is active.

Start a New Call during Conversation

1. Press **Off-hook** key.
The first caller is put on hold.
2. Dial the number.

Note:

You can also start a new call via the Soft key **More > New Call**. Dial the number and press the Soft key **Call**.

Note:

To use the handset contacts to start a new call, just select **More > Contacts** (See [Contacts](#) on page 73). If you start a new call by using the **Off-hook** key or the Soft key **More > New Call**, you cannot select a contact afterward.

Switch between Calls

A new call is started during conversation, the first call is on hold.

1. Press Soft key **R**.

This will switch between the calls.

Note:

You can also switch between the call via Soft key **More > Switch**.

End a Call

A new call is started during conversation, the first call is on hold.

1. Press the **On-Hook** key.

This will end the current call. The held call rings again as priority call.

Note:

You can also end the call via the Soft key **More > End Call**.

It is also possible to end a call by putting the telephone in a charger according to the **In Charger > Call behavior > End call** setting. Note that all ongoing calls will be disconnected. See *Installation and Administration Manual, DECT R4*.

Transfer a Call

A new call is started during conversation, the first call is on hold.

1. Press Soft key **More**.
2. Select **Transfer**.
3. Press Soft key **Select**.

This will connect the first caller with the person you want to transfer the call to.

Transfer to new Call

1. Press Soft key **More** during the call.
2. Select **Transfer to new call**.
3. Press Soft key **Select**.
4. Dial the number to the person you want to transfer the call to.
5. Press **Off-hook** key to transfer the call.

Starting a Conference Call

A new call is started during conversation, the first call is on hold.

1. Press Soft key **More**.
2. Select **Conference call**.
3. Press Soft key **Select**.

The person initiating the conference call is the conference leader, and the other are participant members of the conference call.

Call Back

To enable call back when a call is made to a busy telephone, and to be altered when the telephone is free.

1. Press Soft key **More**.

2. Select **Call back**.
3. Press Soft key **Select**.
4. Press **On-hook** key.
5. Wait until the telephone alerts.
6. When the telephone alerts, press **Off-hook** key.
The call will automatically be started.

Call Waiting

During a call. A second call appears and the a short tone could be heard.

1. Press Soft key **More**.
2. Select **Call waiting**.
3. Press Soft key **Select**.
Your are connected with the new caller. The other part is put on hold.

When the line is free it will automatically call the hold part again. This is system dependent.

Note:

You can also accept the second call by pressing the **Off-Hook** key.

DTMF

During a call.

1. Press Soft key **More**.
2. Select **DTMF**.
3. Press **Select**.
This will enable the use of Dual Tone Multi Frequency (DTMF) signals.

Loudspeaking Function

During a call, the loudspeaking function can be activated.

1. Press left Soft key.

Alternatively, the handset can be put into the charger if **In Charger > Call behavior > Loudspeaking** is set. See *Installation and Administration Manual, DECT R4*.

To turn loudspeaking function off again:

1. Press left Soft key again.

Alternatively, the handset can be put into the charger if **In Charger > Call behavior > Loudspeaking** is set. See *Installation and Administration Manual, DECT R4*.

Call Diversion

All calls, internal calls, external calls, calls when busy, or calls at no answer can be diverted to another telephone number. The diversion is made via the **Calls menu > Call services > Divert calls**. See [Call Services](#) on page 65.

It is also possible to programme a Soft key, Hot key, or Multifunction button with a shortcut to the **Call diversion** function. Refer to [Short Cuts](#) on page 66, and [Divert Internal/External Calls](#) on page 65.

General Purpose

Besides the default Call services functions, it is possible to define 10 extra system specific codes. This is programmed in the PDM or AIWS. See also [Call Services](#) on page 65.

Messaging

For getting information on all Messaging functions see [Messaging](#) on page 68.

Message List

The thirty last received messages are stored in a list. The message list is located in the Messaging menu **Inbox**. Time and date information is included in the message.

Receive a Message

When a text message is received, the LED starts flashing and the message alert signal sounds. The **New message** icon, and a text with information of received message are displayed. The icon will remain in the display until all new messages are opened. If the message is received during a call a beep notifies the user.

1. Press Soft key **Yes** to read the message or to read the message later press Soft key **No**.

The message will in both cases be stored in the Inbox.

It is possible to reply, forward the message, call the sender, and call number in text, irrespective of reading the message directly or later from the inbox, see [Inbox](#) on page 69.

Note:

Messages sent from a message server (AIWS) are shown as **Network** messages. You cannot reply to this sender.

Send a Message

- For text input keys 0-9, * or # can be used.
- Key 0 and 1 contains special characters, see [Alphanumeric Keys](#) on page 34 to see all characters.
- The maximum message length is 160 characters.

Note:

Some characters require 2 bytes in the final message, therefore the user will sometimes not be able to enter 160 characters.

- For basic rules of text input, see [Alphanumeric Keys](#) on page 34.

Write and Send a Message

1. Enter **Messaging** menu.
2. Select **Write new message**.
3. Enter the message text.
4. Press Soft key **Send**.
5. Enter the call number
6. Press Soft key **Send** to send the message.

Voice Mail

Receive a Voice Mail

A new voice mail is indicated by the icon **New message** in the status bar. Information is stored in the **Messaging** inbox, see [Messaging](#) on page 41.

Check the Voice Mail inbox

1. Open the **Messaging** menu, see [Messaging](#) on page 41.
2. Select **Inbox**.
The voice mail will be displayed first in the inbox list.
3. Select the icon **Voice Mail**.
4. Press the Soft key **View**, and then **Call**.

Only one voice mail at the time will be displayed, even if there are more voice mail messages in the message list.

One Key Voice Mail Access

To enable one key Voice Mail Access, your mailbox extension number has to be downloaded to the telephone, see *Installation and Administration Manual, DECT R4*.

Your telephone is in Idle mode.

1. Press long on digit key **1**.
Your voice mail will be called. If the extension number is not available a pop-up **Voice mail number not defined** is displayed.
2. Follow the given instruction in the Voice Mail.

Menu Operation

Figure 5: The main menu.

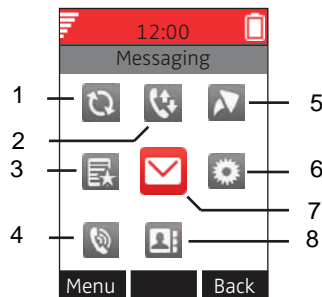

Figure notes:

- | | |
|------------------|---------------|
| 1. Connections | 5. Short cuts |
| 2. Calls | 6. Settings |
| 3. My favourites | 7. Messaging |
| 4. Profiles | 8. Contacts |

Note:

For 3740 DECT telephones, the menu is in monochrome black and white.

Connections

1. Enter the menu by pressing the **Menu** Soft key, or the confirmation button on the Navigation key.
2. Select the **Connections** icon.
3. Press the confirmation button or the Soft key **Select**.

Bluetooth (3749 only)

In the Bluetooth menu you can connect a Bluetooth headset and enable the Bluetooth function. For all information on Bluetooth see [Bluetooth Headset for 3749 phones](#) on page 95.

Headset

1. Select **Headset**.

2. Select headset. Choose between **Mic on boom**, **Hearing protection**, or **Customized headset profile**.

Note:

Customized headset profile is only visible if the headset profile has been configured in the PDM or AIWS.

3. Press **Select**.

System

1. Select **System**.

Change System

1. Select **Change system**.
2. Select **Automatic** or a specific system. If the telephone is set to **Automatic** it selects a system according to the priority list, see [Priority](#) on page 61.

Note:

Automatic doesn't work if your system list comprises IP-DECT *and* Integral DECT systems.

Subscribe System

The cordless telephone can subscribe up to eight different systems. To subscribe a new system the "Park:" (Portable Access Right Key) and "Ac:" (Authentication code) related to the system you are going to log on to are needed. Contact your system administrator for more information.

The IPEI code is a unique code which has been assigned to the cordless telephone, see also [Admin Menu](#) on page 86.

1. Select **Subscribe**.
The IPEI of your telephone is displayed.
2. Press Soft key **Next**.
3. Enter System name.
4. Press Soft key **Next**.
5. Select your system.
6. Press Soft key **Next**.
7. Enter PARK code.

Note:

Do *not* enter a #-key at the end of the code.

8. Enter AC code. Press Soft key **Next**.
An information text "Protection on?" is displayed.

Note:

The AC code's length must be between 4 to 8 digits.

9. Select **Yes/No**, if the new system is to be protected. It is not possible to delete a protected subscription.
10. Press Soft key **OK**. A searching mode starts.

Unsubscribe System

1. Select **Unsubscribe** to delete a System subscription.
2. Select **Delete**.

Note:

It is not possible to delete a protected subscription.

Rename System

It is possible to change the name of the system in the telephone.

1. Select **Rename System**.
2. Select system to rename.
3. Enter new name.
4. Select **Save**.

Priority

The default order of priority is the order of entered subscriptions. This means that the first subscribed system has the highest priority. This list can be edited by the user. It is possible to set the systems in priority by moving them up or down in the list.

Note:

This is used in combination with system set to be **Automatic**, see [Change System](#) on page 60.

1. Select **Priority**.
2. Change the priority if needed by selecting **Up** or **Down**. The priority will be saved when **Back** is selected.

In Charger**In Charger Actions when in Call**

It is possible to end a call, or turn on the loudspeaker by putting the telephone in a charger during a call.

1. Select **In charger**.
2. Select **Call behavior**.

3. Select one of the following:

- **No action** – No action will be performed when the telephone is placed in charger during a call.
- **Loudspeaking** – The loudspeaker will be turned on when the telephone is placed in charger during a call. The loudspeaker will be turned off when removing the telephone from charger.
- **End call** – The ongoing call will be disconnected when the telephone is placed in charger.

Redirect Calls and Messages when Placed in Charger

Calls can be redirected to another extension when the cordless telephone is placed in a charger. Then it will not ring when receiving a call. The function is automatically cancelled when the telephone is removed from the charger.

1. Select **In charger**.
2. Select **Other actions**.
3. Select **Redirect**.

Note:

The function and the extension must be programmed in the PBX to be able to redirect calls.

Switch off While Charging

When the cordless telephone is placed in the charger, it can be switched off while it is charging. When it is removed from the charger, it will switch on again.

1. Select **In charger**.
2. Select **Other actions**.
3. Select **Switch off**.

Sound off While Charging

When the cordless telephone is placed in the charger, the tones can be switched off while it is charging. When it is removed from the charger, the tones will be switched on again.

1. Select **In charger**.
2. Select **Other actions**.
3. Select **Sound off**.

Note:

If the parameter **Disable permanent mute** is enabled, the telephone will not be muted when placed in charger. See *Installation and Administration Manual, DECT R4*.

Deactivate the Charging Mode

1. Select **In charger**.
2. Select **Other actions**.
3. Select **No action**.
4. Press **Select** to save the setting.

Calls

1. Enter the menu by pressing the **Menu** Soft key, or the confirmation button on the Navigation key.
2. Select the **Calls** icon.
3. Press the confirmation button or the Soft key **Select**.

Call List

The 25 last received, dialled or missed calls are stored in a call list. If a number occurs more than once the last time stamp, together with the total number of occurrences, is shown.

1. Select **Call list**.
2. Step with the ▲ and ▼ to scroll in the list.

Dial number from Call list

1. Select number to call.
2. Press Soft key **Call** to dial.

View the Time of a Call

1. Press Soft key **More**.
2. Select **Time of call**. The time and date is displayed.

Edit Number from Call list

1. Press Soft key **More**.
2. Select **Edit number**.

Save Number

1. Press the Soft key **More**.
2. Select **Save number**.
3. Select between **Work number**, **Mobile number**, or **Other number**.

4. Press the Soft key **Add**.
5. Enter name and press **OK** to save the setting.

Send Message

1. Press Soft key **More**.
2. Select **Send message**.

Delete Entry from the Call list

1. Press Soft key **More**.
2. Select entry to delete.
3. Select **Delete**.
4. Select **Yes** to delete the entry from the list.

Delete all Entries from the Call list

1. Press Soft key **More**.
2. Select **Delete all**.
3. Select **Yes** to delete all the entries from the list.

Missed Calls

Note:

A call is defined by your telephone as missed if it is not accepted within a time period specified in PDM or AIWS. Accepting the call later an entry in the missed call list is set, though.

1. Select **Missed calls**
2. Step with the ▲ and ▼ to scroll in the list.
3. Press Soft key **Call** to call back.

As in the menu **Call list**, there is a Soft key **More**, which can be used to view the time/date of the call, edit the received number, add to contacts, and delete received numbers. See [Call List](#) on page 63 for information about the functionality in Soft key **More**.

Call Time

The total time of the previous call and last call is displayed.

1. Select **Call time**.

Call Services

Note:

These functions are system dependent. The parameters are set up in the PDM or AIWS, see *Installation and Administration Manual, DECT R4*.

Divert Calls

The user can divert calls to another extension.

1. Select **Divert calls**.

Divert Internal/External Calls

1. Select **Internal** or **External**.
2. Select **Activate**.
3. Enter number to divert to.
4. Press Soft key **OK**.

To stop diversion select **Deactivate** and press the confirmation button or the Soft key **OK**.

Divert Calls if No Reply

1. Select **No reply**.
2. Select **Activate** and press Soft key **OK**.
3. Enter number to divert to.
4. Press Soft key **OK**

To stop diversion select **Deactivate** and press the confirmation button or the Soft key **OK**.

Divert Calls When Busy

1. Select **When busy**.
2. Select **Activate** and press Soft key **OK**.
3. Enter the number to which calls are to be diverted.
4. Press Soft key **OK**.

To stop diversion select **Deactivate** and press the confirmation button or the Soft key **OK**.

General Purpose

Besides the default Call services functions, it is possible to define 16 extra system specific codes in PDM or AIWS.

Short Cuts

Predefined functions can be set as short cuts for the Soft keys, Hot keys (alphanumeric keys 0, 2 to 9), Navigation keys, and the Multi-function button. It is for example possible to define the Soft key to make a call or as a short cut to send a message.

Note:

On 3749 telephones, the top button is used as an Alarm button. See [Alarm Operations for 3749 telephones](#) on page 82.

Note:

All procedures described in this guide are based on standard Short Cuts settings. This means that your telephone settings can differ from this and e. g. the Soft key **Menu** in idle mode is missing.

1. Enter the menu by pressing the **Menu** Soft key, or the confirmation button on the Navigation key.
2. Select the **Short cuts** icon.
3. Press the confirmation button or the Soft key **Select**.

Define Soft Keys

1. Select **Soft keys**.
2. Select **Left**, **Middle**, or **Right**.
3. Press **Select** to enter a name for the Soft key.
4. Press Soft key **OK**. The default setting of the key is shown.
5. Select **Function**, and press **Select** to select function for the Soft key.
6. Select function from list, and press **Back**.
7. Select **Value** (only for some of the functions), and press **Select**. Enter a value for example a telephone number. Press **Back**.
8. Select **Control question**, and press **Select**. It is off by default. Press **Back**.
9. Press Soft key **Save**.

Define Hot Keys

1. Select **Hot keys**.
2. Select **0**, **2 to 9**.
3. Select **Function**, and press **Select** to select function for the Soft key.
4. Select function from list, and press **Back**.

5. Select **Value** (only for some of the functions), and press **Select**. Enter a value for example a telephone number. Press **Back**.
6. Select **Control question**, and press **Select**. It is off by default.
7. Press Soft key **Save**.

Define Navigation Key

1. Select **Navigation keys**.
2. Select **Up, Down, Left, or Right**.
3. Select **Function**, and press **Select** to select function for the Soft key.
4. Select function from list, and press Soft key **Back**.
5. Select **Value** (only for some of the functions), and press **Select**. Enter a value for example a telephone number. Press Soft key **Back**.
6. Select **Control question**, and press **Select**. It is off by default.
7. Press Soft key **Save**.

Define Multi-function Button for 3740 telephones

The Multi-function button can be defined with two different functions, a long press activates one function, and a double press activates another function.

1. Select **Multi-function button**.
2. Select **Long press**, or **Multi press**.
3. Select **Function**, and press Soft key **Select** to select function.
4. Select function from list, and press Soft key **Select** and then press Soft key **Back**.
5. Select **Value** (only for some of the functions), and press Soft key **Select**. Enter a value for example a telephone number. Press Soft key **Back**.
6. Select **Control question**, and press **Select**. It is off by default.
7. Press Soft key **Save**.

My favourites

In this menu you can store often used numbers. This can be phone call numbers or numbers you want to send a message to.

1. Enter the menu by pressing the **Menu** Soft key, or the confirmation button on the Navigation key.
2. Select **My favourites** icon.

3. Press the confirmation button or the Soft key **Select**.

Add favourites

1. Select **Add new**.
2. Enter name of the new favourite.
3. Press Soft key **OK**.
4. Select **Phone call**, or **Send message**.
5. Enter call number.
This can be a simple call number but even a complex combination of feature access code and call number, e. g. to realize a specific feature.
6. Press **Save**.

Edit favourites

1. Select an existing favourite you want to edit.
2. Press the Soft key **More**.
3. Select **Edit**.
4. Select Name, Function, or phone number you want to change.
5. Edit the existing value.
6. Press **Save**.
7. Press **Back**.

Delete favourites

1. Select favourite you want or delete.
2. Select **More**.
3. Select **Delete**.
4. Select **Yes** to delete the favourite.

Messaging

1. Enter the menu by pressing the **Menu** Soft key, or the confirmation button on the Navigation key.
2. Select the **Messaging** icon.
3. Press the confirmation button or the Soft key **Select**.

Inbox

1. Select **Inbox** to view the message list.
2. Select a message by using the ▲ and ▼ on the navigation key.

Read a Stored Message

1. Press Soft key **View** to read the message.

Reply to Sender

1. Select **View**.
2. Select **Reply**.
3. Enter text.
4. Select **Send**.

Delete Message

1. Select **More**.
2. Select **Delete**.
3. Select **Yes** to delete the message.

Forward Message

1. Select **View**.
2. Select **More**.
3. Select **Forward**.
4. Enter additional text if needed.
5. Select **Send**
6. Enter number.
7. Select **Send** to forward the message.

Call Sender

1. Select **View**.
2. Select **More**.
3. Select **Call Sender**.

Call number in text

If the sender has written a telephone number in the message it is possible to call the number without dialling it.

1. Select **View**.
2. Select **More**.
3. Select **Call (No. in text)**.
4. Select number from the list.
5. Select **Call**.

Save Number

1. Select **View**.
2. Select **More**.
3. Select **Save number**.
4. Select **Work Number**, **Mobile number**, or **Other number**.
5. Press the Soft key **Add**.
6. Enter the name for the contact.
7. Press the Soft key **OK**.
8. Press the Soft key **Save**. The number will be saved in the contact list.

Write New Messages

1. Select **Write new message**.
2. Enter text.
3. Press **Send**. See also [Messaging](#) on page 57.
It is possible to save the message and send it later by pressing the Soft key **Back** and select **Yes**. The message will be stored under **Unsent messages**. See [Unsent Messages](#) on page 70.
4. Enter number, or press middle Soft key to get number from contact list.
5. Press **Send**.

Unsent Messages

1. Select **Unsent** to view the list.
2. Select message to edit/send.
3. Select **Edit**, edit text and/or just select **Send**.

Delete/Delete All

1. Select **More**.
2. Select **Delete** or **Delete all**.

3. Select **Yes** if the unsent message shall be deleted.

Sent Messages

1. Select **Sent** to view the list.
2. Select a message by using the ▲ and ▼ on the navigation key.

Delete/Delete all

1. Select **More**.
2. Select **Delete** or **Delete all**.
3. Select **Yes** if the unsent message shall be deleted.

Read a sent Message

1. Select **View** to read the message.

Forward message to another Destination

1. Select **View**.
2. Select **Forw.**
3. Enter additional text if needed.
4. Select **Send**.
5. Enter number.
6. Select **Send**.

Call number in text

If the sender has written a telephone number in the message it is possible to call the number without dialling it.

1. Select **View**.
2. Select **More**.
3. Select **Call (No. in text)**.
4. Select number from the list.
5. Select **Call**

Save Number

1. Select **View**.
2. Select **More**.
3. Select **Save number**.

4. Select **Work Number/Mobile number/Other number**.
5. Press Soft key **Add**.
6. Enter name for the contact.
7. Press Soft key **OK**.
8. Press Soft key **Save**. The number will be saved in the contact list.

Profiles

It is possible to set up an own profile for incoming calls, message alerts, vibrating alerts, key sound etc. This can be useful when there are many users on the same telephone, and they want different sound profiles. It can also be used for temporarily settings, for example while in a meeting incoming calls should be silent. It is easy to switch between the different profiles.

Note:

Changing settings is not possible on a telephone which is set to a profile. You have to leave the profile before.

1. Enter the menu by pressing the **Menu** Soft key, or the confirmation button on the Navigation key.
2. Select **Profiles** icon.
3. Press the confirmation button or the Soft key **Select**.

Add new Profile

1. Press Soft key **Add new**.
2. Enter name of the profile and select **Save**.
3. Select profile from list and change profile as wanted.

Delete Profile

1. Select profile from list.
2. Press Soft key **More**.
3. Select **Delete** from menu.
4. Press Soft key **Delete**.
5. Press Soft key **Yes** to confirm.

Edit Profile

1. Select profile from list.
2. Press Soft key **More**.

3. Select **Edit** from menu.
4. Select what to edit and press Soft key **Edit**.
5. Make changes and press Soft key **Save** to confirm.

Contacts

The telephone has a personal phonebook with 250 entries, where names and numbers freely can be added, deleted, and edited by the user. The phonebook lists all names in alphabetical order, where three numbers can be added for each contact; work number, mobile number, and other number.

It is also possible to access a central phonebook. The user then sends a request to a messaging server with the first characters entered, and the messaging server will return a list of names and numbers that matches the search.

A company phonebook can be downloaded via the PDM. Contacts from the Company phonebook appears in the contacts list menu with a lock symbol next to the name/number, which means that it is not editable. The contact will only include work number.

Note:

You can import personal contacts or a local company phonebook by using WinPDM or DM. Refer the handset configuration manual in the *Installation and Administration Manual, DECT R4*.

Open personal phonebook

1. Enter the menu by pressing the **Menu** Soft key, or the confirmation button on the Navigation key.
2. Select **Contacts** icon.
3. Press the confirmation button or the Soft key **Select**.

Call Contact

1. Select **Call contact**.
2. Select contact from the list, or enter name in the search field.
3. Press Soft key **Call**.

It is also possible to edit the contact and to send a message by selecting **View > More**.

Add Contact

1. Select **Add contact**.

Add New Contact

1. Select **New**.
2. Select **Add**, and enter the name of the contact.
3. Press Soft key **OK**.
4. Select **Work Number/Mobile number/Other number**.
5. Press Soft key **Add**.
6. Enter telephone numbers.
7. Press Soft key **OK**.
8. Press Soft key **Save** and then **Back**.

Different ring signals can be set to distinguish this contact from another contact.

Add from Call List

1. Select **From call list**.
2. Select number.
3. Press Soft key **Add**.
4. Select number type.
5. Press Soft key **Select**.
6. Press Soft key **Add**, and enter name for the contact.
7. Press Soft key **OK**.
8. Press Soft key **Save**.

Edit Contact

1. Select **Edit contact**.
2. Select contact, and press Soft key **Edit** twice.
3. Enter new name/number, and press **OK**.
4. Press Soft key **Save**.

Delete Contact

1. Select **Delete contact**.
2. Select contact, and press **Delete**.
3. Press Soft key **Yes** to confirm.

Central Phonebook

In the Central phonebook it is possible to search by name or number. The last search result can be displayed.

When the search result is ready it is possible to view contact information, add the number to new contact, and to send a message by selecting the Soft key **More**. You can also call the number by selecting the Soft key **Call**.

1. Select **Central phonebook**.

Search by Name

1. Select **Search by name**.
2. Enter First name and/or Last name.
3. Select **Search**.
The search result will be displayed.

Search by Number

1. Select **Search by number**.
2. Enter telephone number.
3. Select **Search**.
The search result is displayed.

View Last Search Result

1. Select **Last result**.
Only the last result will be displayed.

Settings

1. Enter the menu by pressing the **Menu** Soft key, or the confirmation button on the Navigation key.
2. Select the **Settings** icon.
3. Press the confirmation button or the Soft key **Select**.

Sound and Alert Settings

Adjust the Ringer Volume

1. Select **Sound & Alerts**.
2. Select **Volume**.

3. Step with ► to increase the volume and with ◀ to decrease it.
4. Press Soft key **OK** to save the setting.

Note:

When the volume is set to silent, the  icon is shown in the display. If the parameter **Disable permanent mute** is enabled, it is not possible to set the ring volume to silent. See *Installation and Administration Manual, DECT R4*.

Set different Ring Signals for Internal Call, External Call and Priority Call

Different signals for internal calls, external calls and priority calls can be set. The cordless telephone has 14 different ring signals.

1. Select **Sound & Alerts**.
2. Select **Ring signals**.
3. Select **Internal call, External call or Priority call**.
4. Select sound. By pressing **Play**, it is possible to listen to the different sounds.
5. Press Soft key **Back**.

Set different Message Alerts for Mail

Different message alerts can be selected. The cordless telephone has 8 different message alerts (default), see [Settings](#) on page 44.

1. Select **Sound & Alerts**.
2. Select **Message alert**.
3. Select message alert from list. By pressing **Play**, it is possible to listen to the different sounds.
4. Press Soft key **Back**.

Turn the Vibrator on/off

1. Select **Sound & Alerts**.
2. Select **Vibrating alert**.
3. Choose between **On, On if silent** (that is, the vibrator is on when the telephone is muted), or **Off**.
4. Press the Soft key **Back**.

Set the Key Sound

This means that every time a key is pressed, the telephone gives a small sound. You can choose between **Silent, Click, or Tone**.

1. Select **Sound & Alerts**.
2. Select **Key sound**.

3. Select between **Silent**, **Click**, or **Tone**.
4. Press the Soft key **Back**.

It is possible to listen to the key sound by pressing the Soft key **Play**.

Phone Lock settings

Activate the Automatic Key Lock

1. Select **Locks**.
2. Select **Automatic key lock**.
3. Select **On** for activation of automatic key lock.

Activate the Phone Lock

The telephone can be protected for unauthorized use. If this function is set to **On** it locks automatically a short time after the last keystroke and a PIN code has to be entered at power on. When it is set to **On in charger** it locks when switched off or placed in a charger. The default phone lock code (0000) can be changed to any 4 -8 digit personalized code.

Note:

If the PIN code is forgotten it can be removed by your administrator.

1. Select **Locks**.
2. Select **Phone lock**.
3. Select **Auto phone lock**.
4. Select **On**, or **On in charger**.
5. Enter PIN code
6. Press Soft key **OK**.

Deactivate the Phone Lock

1. Select **Locks**.
2. Select **Phone lock**.
3. Select **Auto phone lock**.
4. Select **Off**.
5. Enter PIN code
6. Press Soft key **OK**.

Change PIN Code

1. Select **Locks**.
2. Select **Phone lock**.

3. Select **Change PIN code**.
4. Enter the old PIN code.
5. Press Soft key **OK**.
6. Enter the new PIN code.
7. Scroll down with ▼ to **Confirm PIN code**.
8. Enter the new PIN code again.
9. Press Soft key **Save**.

Display Settings

Brightness

1. Select **Display**.
2. Select **Brightness**.
3. Select **Normal** or **Power save**.
4. Press Soft key **Back**.

Screen Saver

Time and status information will be displayed when **Information** is selected, and the display will turn off when the telephone is not used.

1. Select **Display**.
2. Select **Screen saver**.
3. Select **Information**, or **Black**.
4. Press Soft key **Back**.

Contrast

1. Select **Display**.
2. Select **Contrast**.
3. Adjust the contrast by pressing ► to increase and ◀ to decrease the contrast.
4. Press the Soft key **Back**.

Time & Date Settings

Time and date is set in your PBX. Changes appear in the telephone after a maximum of 24 hours after the change or by turning the telephone off and on again.

Set Time Format

1. Select **Time & Date** and press **Select**.
2. Select **Time format**. The actual time format will be displayed. Selectable time format:
 - 11:00pm
 - 23:00
3. Press **Select** to save the setting.

Set Date Format

1. Select **Time & Date** and press **Select**.
2. Select **Date format**, press **Select**. Selectable date format:
 - DD/MM/YYYY, e.g. 17/09/2008 (also called Europe)
 - MM/DD/YYYY, e.g. 9/17/2008 (also called US)
 - YYYY-MM-DD, e.g. 2008-09-17 (ISO 8601)
 - MMM DD YYYY, e.g. Sept 17 2008
 - DD MMM YY, e.g. 17 Sept 08
 - DD.MM.YYYY, e.g. 17.09.2008
 - DD-MM-YYYY, e.g. 17-09-2008
3. Press **Select** to save the setting.

Answering

The default setting for the telephone is to use the Off-hook key when answering a call. The answering behavior can be configured to answer the call automatically, that is, without pressing a key, or/and in loudspeaking mode. It is also possible to set the answering behavior to any key or hook-off.

Note:

The automatically answer mode is only relevant when a headset is connected.

1. Select **Answering**.

Answering Key

The answering key is by default set to **Hook-off**. It can also be set to **Any key**.

1. Select **Answering key**.
2. Mark **Any key** or **Hook-off**.
3. Press Soft key **Back** to save the setting.

Answering Behavior

1. Select **Answering behavior**.
2. Select **Automatically / Loudspeaking**.
3. Press Soft key **Change** to change the setting. The check box will be marked. To remove the setting, press Soft key **Change** again.
4. Press Soft key **Back** to save the setting.

Change Text size for Messages

1. Select **Messages**.
2. Select **Text size Normal**. The default text size is **Normal**.
3. Select **Normal** or **Large**.

Change the Menu Language

You can choose between; Brazilian, Brazilian Português (Brazilia), Português (Portugues), Čeština (Czech), Dansk (Danish), Deutsch (German), English, Español (Spanish), Français (French), Ελληνικά (Greek), Magyar (Hungarian), Italiano (Italian), Nederlands (Dutch), Norsk (Norwegian), Polski (Polish), Русский (Russian), Slovenčina (Slovakian), Soumi (Finish), Svenska (Swedish) and Türkçe (Turkish).

You can import one user-defined language by using WinPDM or DM. See the handset configuration manual in the *Installation and Administration Manual, DECT R4*.

Note:

In every language the menu item ***language** is shown with a prefixed Asterisk "*". This might help you to change the language of a telephone set to a language you do not understand.

1. Select ***Language**.
2. Select language.
3. Press Soft key **Select** to save the setting.

Change Owner ID

The Owner ID is set to identify the telephone and it's shown in the idle display.

1. Select **Owner ID**.
2. Enter identity.
3. Press Soft key **Save**.

Alarm Settings (for 3749 telephones)

Activate alarm

1. Select **Alarm**.
2. Select **Activate alarm**.
3. Select **Man-down** and/or **No-movement**.
4. Press **Select** to change the setting. The check box is selected.
5. Press **Back** to save the setting. To remove the setting, press **Select**. The check box is cleared.

When an alarm is activated, the corresponding alarm icon is shown, as shown in the table below.

Table 1: Alarms icons



Man-down alarm



No-movement alarm

Note:

The Man-down alarm and No-movement alarm can be disabled manually during calls to avoid sending false alarms when the user tilts the telephone or does not move during the call. If the Man-down and No-movement alarms are disabled during calls, the corresponding icons are not displayed. A shortcut can be configured to open the alarm menu quickly.

See [Alarm Operations for 3749 telephones](#) on page 82 for additional information.

Device info

This is where software and hardware information of the cordless telephone is found.

1. Select **Device info**.
2. Depending on the info your are looking for select **Software**, **Hardware**, **IPEI/IPDI**, or **USER ID**.

Alarm Operations for 3749 telephones

Note:

The alarm settings described in this chapter can only be configured in PDM or AIWS.

Push-Button Alarm

The push-button  can be defined to send an alarm by a long press and by multiple press. By default, long press is defined for test alarm (see [Test Alarm](#) on page 82), and multiple press is defined for personal alarm (see [Personal Alarm](#) on page 82).

Test Alarm

Press and hold the push-button  until the dialog window Test Alarm (default) is displayed. Depending on set parameters, following occur:

- A beep is heard.
- The orange LED flashes twice.
- The vibrator stirs.
- The telephone receives a notification that the alarm has been received by the system. This is a system dependent feature.
- An acoustic location signal (ALS) is played. See [Acoustic Location Signal](#) on page 83.
- A call to a predefined number is established. See [Automatic Call after Alarm](#) on page 84.

Note:

When the vibrator is enabled, the telephone will alternate between vibration and sound. That is, vibration and sound are not activated simultaneously.
The ALS will no be played if the Automatic call after alarm option is enabled.

Personal Alarm

Press the push-button  twice or more, the dialog window Personal Alarm (default) is displayed. Depending on set parameters, following occur:

- A beep is heard.
- The orange LED flashes twice.
- The vibrator stirs.

- The telephone receives a notification that the alarm has been received by the system. This is a system dependent feature.
- An ALS is played. See [Acoustic Location Signal](#) on page 83.
- A call to a predefined number is established, see [Automatic Call after Alarm](#) on page 84.

Note:

When the vibrator is enabled, the telephone will alternate between vibration and sound. That is, vibration and sound are not activated simultaneously.
The ALS will no be played if the Automatic call after alarm option is enabled.

Man-Down and No-Movement Alarm

Man-down alarm: If the telephone is tilted 45° (default) or more for a preset time (default 7 seconds), the Man-down alarm is triggered.

No-movement alarm: If no movement is detected during a preset time (default 30 seconds), the No-movement alarm is triggered.

When an alarm is triggered, the following occur depending on the settings:

- A dialog window "Man-down warning. Cancel?" or "No- movement warning. Cancel?" is shown in the display, and a warning tone is also played for a period (default 7 seconds) before the alarm is sent.
- To prevent the alarm from being sent and to silence the warning tone, do one of the following:
 - Press any key or button. The alarm is reset.
 - Put the telephone in a charger. The alarm is temporarily disabled, and the corresponding alarm icon is hidden. The alarm is enabled when you remove the telephone from the charger.
- If no key or button is pressed during the warning tone, the alarm is sent. Depending on set parameters, a beep, vibrator, or LED signal confirms that the alarm has been sent.
- An ALS may be activated after the alarm has been sent. See [Acoustic Location Signal](#) on page 83.
- A call to a predefined number is established. See [Automatic Call after Alarm](#) on page 84.

Acoustic Location Signal

Depending on set parameters, the ramped up ALS is played after an alarm. The signal is always ramped from the lowest volume to the highest. Press the Mute button to turn the ALS off.

Depending on the PDM settings, it is possible to make the user enter a password when turning the ALS off. This password is the same as the phone lock password.

ALS is configurable for Man-down and No-movement alarm and Push-button alarm.

Automatic Call after Alarm

A telephone can be configured to call a predefined number after an alarm has been sent. If configured, it is also possible to call the predefined number without sending an alarm by pressing the Alarm button . Depending on the settings, the call can be established in the following modes:

- Loudspeaking mode
- Normal mode

Note:

When Bluetooth is enabled, the loudspeaker audio is lowered due to current limitations in the intrinsically safe 3749 telephone.

Advanced Functions

Procedure Call

When configuring the functions Call services, In Call menu, Contacts, or a shortcut/favourite to the *Phone call* function, the data added in these functions is static. When entering the data for the function to be used, it is possible to add a variable *U* that allows the user to enter additional numerical characters before calling the number or sending the data to a system.

Note:

Configuration of Call services and In Call menu functions requires PDM/AIWS.

**Tip:**

If you are configuring the Phone call function, see the following example for more information.

Example of configuration:

A user wants to create a Favourite with the Phone call function. The PBX requires that a prefix must be added to a phone number. In this case, the user can pre-program the prefix and then enter the applicable phone number when using the Phone call function.

1. Press **Menu**, or the confirmation button.
2. Select **My Favourites**.
3. Select **Add new**.
4. In the **Name** field, enter "Call no."
5. Select the function **Phone call**.
6. In the **Number** field, enter the prefix to be used followed by the character *U*. In this case, the text string is as follows *21**U*. The character *U* represents an Enter number dialog where the user can enter the phone number.
7. Press **Save**.

When using the function, an Enter number dialog appears, see [figure 6](#). If the user enters "123" and presses **OK**, the number *21*123 will be dialled. Note that no call is established before the user presses **OK**, that is, post-dial.

Figure 6: Enter number dialog.

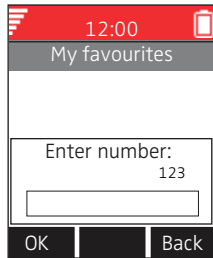

Admin Menu

The telephone has a hidden menu for system administrators. See also *Installation and Administration Manual, DECT R4*.

The Admin menu contains:

- Software and hardware information, IPEI/IPDI and user ID
- DECT information
- Centralized Management showing online information
- Fault logging
- Factory reset option
- System menu with ability to alter protection
- Site Survey Tool for indication of radio signal and base station listing.

For activating the admin menu see *Installation and Administration Manual, DECT R4*.

For quick access to device information short codes are available in the idle menu.

| Information | Code |
|------------------|-------|
| Software version | *#34# |
| Hardware version | *#34# |
| IPEI | *#06# |
| IPDI | *#06# |

Clear Lists in Charger

Via PDM or AIWS it is possible to set a parameter that will clear messaging lists and call lists that has been stored in the cordless telephone. When the parameter is activated and the function has been downloaded to the cordless telephone, the lists will be deleted when placed in a charger. This can be useful during administration of cordless telephones for new users. See also *Installation and Administration Manual, DECT R4*.

System Handling

Software Upgrade

Software and parameters in the Avaya 3740 and 3749 DECT Telephone can be upgraded by using the PDM or the AIWS. See *Installation and Administration Manual, DECT R4*.

To view the telephone's software version, enter `*#34#` in idle mode.

Troubleshooting

This section contains information on how to solve common operational problems, and warnings you may receive.

Go through the following lists if you encounter any problems. If this checklist does not solve the problem, contact your system administrator.

If others have similar problems, there may be a system error.

Operational Problems

| Fault | Probable cause | Action or comment |
|--|--|--|
| No display | The battery level is low or the telephone is defective. | Charge the battery or contact system administrator. |
| No ringing | The sound off icon is on, or ringer volume set to silent, or the telephone is defective. | Long press the Sound off key, or increase volume, or contact system administrator. |
| No change in time & date setting | PBX dependent. | Changes in the telephone appear after a maximum of 24 hours after a change in the system or by turning the telephone off and on again. |
| Bad sound during conversation in a call or for any dial tones on the 3749 in loudspeaker mode. | The handset loudspeaker volume level is set to high for the current connection. Received speech volume of dialog person is too loud. | Reduce volume for the loudspeaker. |

Error or Warning Messages

| Display shows | Probable cause | Action or comment |
|---|---|---|
| No access | The network is in range, but no access rights. | Switch telephone off and then switch it on again or contact system administrator. |
| No System. The telephone beeps once a minute (during max 30 minutes) with a low tone followed by a high tone (if enabled, the vibrator also follows the beeps). | The telephone is out of coverage or telephone is defective. | Stop the beep with the Sound off key and go into range. Note: When re-entering the coverage area it can take a couple of minutes before the telephone automatically has registered into the system. or contact system administrator. |

| Display shows | Probable cause | Action or comment |
|---|--|---|
| SERVICE NEEDED Parameters corrupt | The telephone is defective. | Select the reset option on the middle Soft key if available. Upgrade the telephone's software to version 3.0.0 or greater. If the problem persists, the telephone needs repair. Note: Display message only shown in English. |
| Enter PIN code | The telephone's lock is activated. | Enter the required PIN code. If PIN code lost enter new via PDM or do a factory reset via PDM. |
| Battery low, charge now | The battery level is low. | Charge or replace the battery. |
| Phonebook is not available at the moment. | The phonebook does not respond, not available at the moment. | Try again later or if fault persists do a factory reset via admin menu or PDM. |
| Voice mail number not defined | There is no Voice mail number defined in the telephone. | Define a Voice mail number via PDM. |

Operation Notice

Accessibility and Voice Quality

The base network is not always available. If you do not get in contact with your system, contact your system administrator. For best voice quality, avoid positioning near computer, radio or similar equipment.

Operating Area

You can only use your cordless telephone in the area that is covered by your system. Outside this area, you will lose contact with the system. The signal strength icon will be low and **Searching** text will be displayed.

Out of Range

A system administrator can use WinPDM to adjust the Out of range alert signalling. When the phone loses connection to the system, the handset displays the Searching text and plays a beep every minute for a maximum of 30 minutes. You can turn off the beep or set it to play only once. See [Descriptions](#) on page 24.

Note:

If the parameter **Disable permanent mute** is enabled, it is not possible to turn the sound off. See *Installation and Administration Manual, DECT R4*.

When re-entering the coverage area, it can take a couple of minutes before the telephone is automatically registered into the system.

Maintenance

Charge the Battery

Place the telephone in the desktop charger or in the rack charger. The battery is being charged when the LED on the telephone is steady orange. When the battery is fully charged the LED will be green.

 An animated battery icon is also shown in the display indicating charging by starting with its current charge and ending with the full charge. A filled Battery icon indicates a fully charged battery.

Note:

Only use the prescribed chargers for charging.



CAUTION:

On the 3749 telephones, battery charging or replacement is NOT permitted in a hazardous area. When charging the EX classified handset, it is only permitted to use a charger marked with DC3-CAAB/1A (or greater), DC4-CAAB/3A (or greater) or CR3-CAAB/2A (or greater) on the label. It is not permitted to charge the EX battery pack alone.

Charge Spare Batteries

Spare batteries can be charged with a separate Multiple Battery Charger. It can charge six batteries at the same time.

Replace the Battery

If the standby time for the cordless telephone becomes too low, the battery should be replaced by a new one. Please contact your system administrator or your supplier, for information about new batteries. Attach the battery as described in the illustration below. The battery is easy to replace. It is attached inside the battery lid and is connected to the cordless telephone in such a way that no miss-contact is possible.

For 3749 phones, a specific tool is required and specific environmental conditions need to be considered before replacing the battery.

⚠ CAUTION:

On the 3749 battery charging or replacement is NOT permitted in a hazardous area.

Figure 7: Easy replaceable battery, unlock the lid and remove the battery

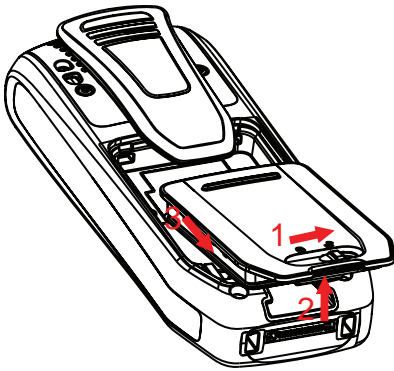

3740 telephone

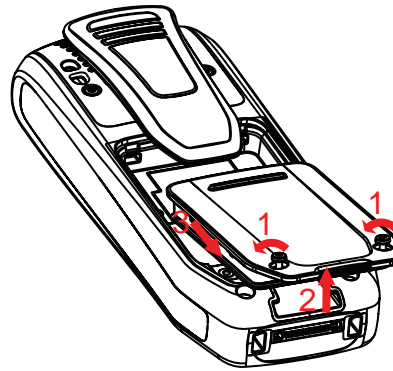

3749 telephone

Attach the Hinge-type Clip

Attach the hinge-type belt clip as described in the illustration below.

Figure 8: Screw the hinge-type clip into position

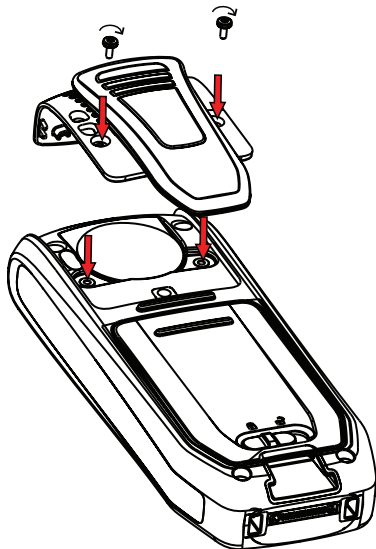

3740/49 telephone

Attach the Swivel-type Clip

Attach the swivel-type belt clip as described in the illustration below.

Figure 9: Screw the swivel-type clip into position

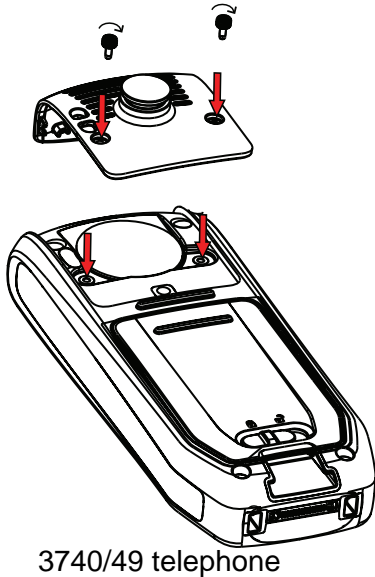

Attach Cover for No Clip

Attach the enclosed cover as described in the illustration below when no clip is to be used.

Figure 10: Screw the cover into position

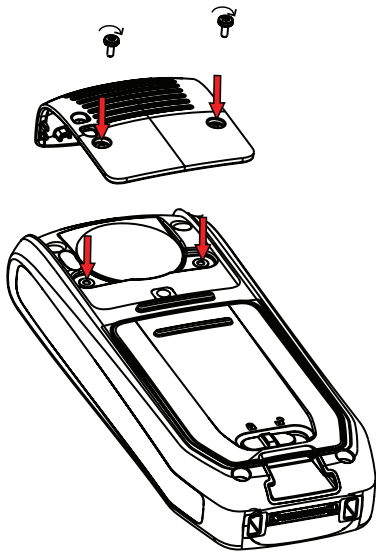

3740/49 telephone

Bluetooth Headset for 3749 phones

Introduction

Bluetooth technology replaces the cord between the cordless telephone and the headset. This allows the user to move more freely and eliminates the risk of a headset cord getting stuck.

The Bluetooth is factory mounted on the cordless telephone's circuit board.

Bluetooth supported functions:

- Pair the cordless telephone with it's headset
- Chose which device to use when making a call
- Play ring signal in the Bluetooth Headset
- Answer and connect sound to the Bluetooth Headset when answering with the headset's button.
- End call with the Bluetooth headset's button
- Transfer audio to/from Bluetooth headset during call, using the menu in the cordless telephone.
- Increase/decrease the volume in the Bluetooth headset with the volume buttons on the cordless telephone.

Wear

For optimal performance wear the Bluetooth headset and the telephone on the same side of your body. The best audio quality in the headset is achieved when no obstructions, including your body, are between the headset and the cordless telephone.

Figure 1: Wear the headset and the telephone on the same side of your body.

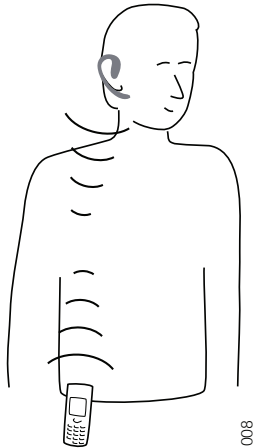

Headsets

A number of Bluetooth headsets for different work situations have been tested together with the telephone. Refer to the *Installation and Administration Manual, DECT R4* for a list of verified Bluetooth headsets.

Since the Bluetooth supports the Bluetooth 2.0 standard, other headsets may also work although not verified by Avaya.

Note:

Your Bluetooth headset may have more or less functions than described here, refer to the Manual for the Bluetooth headset.

Operation

Step between the menus with the navigation key. Confirm each menu selection by pressing the Soft key **Select**.

Enable Bluetooth

1. Enter the menu by pressing the **Menu** Soft key, or the confirmation button on the navigation key.
2. Select **Connections** icon.
3. Select **Bluetooth**.
4. Select **Enable**. A Bluetooth connection icon  will be displayed in the header bar.

Note:

To disable Bluetooth again, select **Disable**. The 3749 cordless telephone restarts when you enable or disable the Bluetooth option.

Pair and Connect a Bluetooth Headset

Before a headset can be used a connection (pairing) between the headset and the telephone must be established.

1. Place the Bluetooth headset and the telephone next to each other.
2. Select **Connections** icon in the telephone menu.
3. Select **Bluetooth > Headset > Add new**.
4. Put the headset in pairing mode and press the Soft key **OK**. The telephone starts to search for the headset.

Note:

For instruction, see headset manual.

5. The headset is displayed in the telephone menu **Headset found**. Press the Soft key **Select** on the telephone to select the headset. The pairing starts.
6. A PIN-code is requested for the Bluetooth headset. Enter the PIN-code and press **Select** on the telephone. **Pairing successful** is displayed.

Note:

For instruction, see headset manual.

7. The paired headset is displayed in the telephone menu **Headset**. When pairing a new headset it is automatically connected and will be used for calls.

Add another Bluetooth Headset

Up to four headsets can be paired to the telephone, but only one at a time can be selected. To pair another headset repeat section "Pair and Connect a headset" steps 1-6.

The paired headsets are displayed by a default name in the telephone menu **Headset**. See 6. *Confirm with the Soft key Select.*

Select a Bluetooth Headset

1. Select **Connections** icon in the telephone menu.
2. Select **Bluetooth > Headset**.
3. Step with the navigation key, **▲** or **▼** to the headset to be selected.
4. Press the Soft key **Select**, **Connection successful** is displayed. The headset is now selected.

When a new headset has been selected any previous headset will automatically become disconnected.

Remove a Headset

1. Select **Connections** icon in the telephone menu.
2. Select **Bluetooth > Headset**.
3. Step with the navigation key, ▲ or ▼ to the headset to be removed.
4. Press the Soft key **More**.
5. Select **Delete**.
6. Confirm with the Soft key **Select**.

Change the name of Bluetooth headset.

The name, in the headset list, of the headset is the default name for the headset.

1. Select **Connections** icon in the telephone menu.
2. Select **Bluetooth > Headset**.
3. Step with the navigation key, ▲ or ▼, select the headset.
4. Select **More > Edit name**.
5. See [Alphanumeric Keys](#) on page 34.

Calling

Make a Call

1. Enter the number on the telephone.
2. Press the Soft key **Call** or the **Off-hook** key.
3. When **Transfer call to phone?** is displayed press **No** or ignore the message to use the Bluetooth Headset.
4. Press **Yes** to use the telephone.

Answer a Call

A ring signal sounds in both the selected Bluetooth headset and the telephone to signal an incoming call.

To answer the call in the Bluetooth headset, press the button* on the headset.

To answer the call in the telephone press the **Off-hook** key on the telephone.

End a Call

Press the button* on the headset or the **On-hook** key on the telephone.

Volume/Mute Control

Adjust the Volume During a Call

Press the upper **Volume up** button on the upper left side of the telephone to increase the volume and the **Volume down** button to decrease the volume in the headset.

Depending on the Bluetooth headset it might be possible to adjust the volume directly on the headset*.

Turn the Microphone On/Off During a Call

Mute the headset and the telephone with the **Sound off** key on the telephone. See [Switch the Telephone On/Off](#) on page 47.

Messaging

When a text message is received a beep sounds in the Bluetooth headset.

Transfer a call

Transfer a Call to the Telephone

You are on a call with the Bluetooth Headset.

1. Press the Soft key **More** on the telephone.
2. Select **Audio transfer**.

Transfer a Call to the Bluetooth Headset

You are on a call with the telephone.

1. Press the Soft key **More** on the telephone

2. Select **Audio transfer**.

It is also possible to transfer a call to the Bluetooth headset by pressing the button* on the Bluetooth headset.

Switch to a Headset with Cord

If a headset with a cord is connected during a call, the call is transferred to this headset automatically.

Menu Tree

See [Settings](#) on page 44.

Operation Notice

Accessibility and Voice quality

Bluetooth uses the frequency of 2.45 GHz. WLAN, microwave oven, and other devices that use the same frequency can disturb the use of a Bluetooth headset.

Operation Area

Maximum distance between the headset and the telephone is 10 metres. The communication distance between the telephone and headset may vary considerably due to the environment and disturbances from other 2.45 GHz equipment. Different headsets can also give different communication distances.

Out of Range

If a connection cannot be made with the selected Bluetooth headset the call is transferred automatically to the telephone.

If the Bluetooth headset and the telephone get out of range from each other the connection is temporarily lost. Since the last connected headset is always considered **selected**, the connection is automatically established again when a call is made or received.

Environmental Requirements

Bluetooth Headset Battery

See the manual for the Bluetooth headset.

Troubleshooting

| Problem | Reason | Solution |
|---|---|--|
| No headset found | Headset is turned off | Turn on headset |
| | Headset is out of battery | Charge headset |
| | Headset is out of range | Move headset closer to telephone < 10 meter. |
| Pairing fails | Headset is not in pairing mode | Turn headset into pairing mode (see headset manual for details) |
| | Incorrect PIN entered | Try again and enter correct PIN (see headset manual for details) |
| | Headset is not in pairing/ discoverable mode (see headset manual for details) | |
| Connecting fails/Failed to connect headset | Headset is not turned on | Turn on headset |
| | Headset is out of range | Move headset closer to telephone |
| | Link key in headset has been deleted | Repeat pairing procedure |
| | Headset is already connected to another telephone | Disconnect headset from the other telephone |
| Headset can not connect to telephone (see headset manual for details on how to connect) | Too close to disturbing devices. | Disturbing devices can be WLAN equipment, microwave etc. |
| | Telephone is not turned on | Turn on telephone |







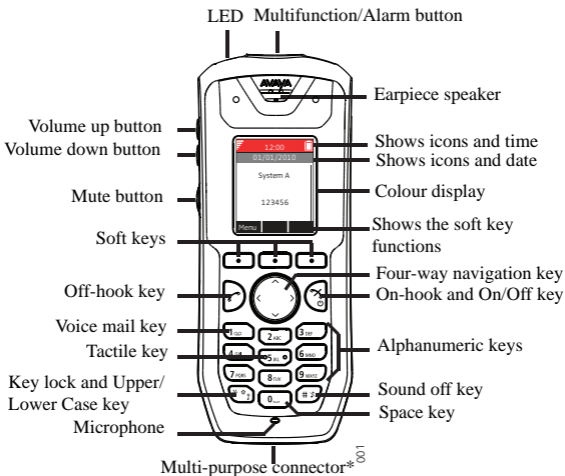













| Problem | Reason | Solution |
|----------------|---|--|
| | Telephone is out of range | Move telephone closer to headset |
| | Bluetooth module is disabled | Enable Bluetooth in Bluetooth menu |
| | Another headset is already connected to the telephone | Disconnect the connected headset |
| | Link key is missing in either headset or telephone. | Repeat pairing procedure |
| | Too close to disturbing devices. | Disturbing devices can be WLAN equipment, microwave etc. |





















Avaya 374x DECT
Telephone
Quick Reference Guide



**)Used for battery charging, software download, configuration and connection of headsets.*

| | | |
|---|---|---|
| 3749 | 3740 | Display Icons |
|  |  | Signal strength |
|  |  | Battery status |
|  |  | Voice mail |
|  |  | Sound off |
|  |  | Ring volume set to silent |
|  |  | Loudspeaker on |
|  |  | Loudspeaker off |
|  |  | Microphone off |
|  |  | Headset connected |
|  | | Bluetooth headset connected (only for 3749) |
|  | | Bluetooth (only for 3749) |
|  | | Man-down alarm(only for 3749) |

| | | |
|---|---|-----------------------------------|
|  | | No-movement alarm (only for 3749) |
|  |  | New message |
|  |  | Read message |
|  |  | Missed call |
|  |  | New missed call |
|  |  | Incoming call |
|  |  | Outgoing call |
|  |  | System connection |
|  |  | Key lock |
|  |  | Phone lock |

Product presentation

The cordless telephone is a feature-rich handset with colour display, telephony, messaging, and bluetooth. It is designed to be used in office environment and medium demanding environment such as hospital environment.

It is suitable for users dependent of being reachable and/or having a need for mobile voice and messaging features, which makes it ideal for applications where the user needs either one way messaging or to be able to interact with other users. The colour display enhances and simplifies the use of the cordless telephone.

Read the safety instructions before use.

For software download and parameter set up, read the *Installation and Administration Manual, IP DECT*

| <i>Functions</i> | <i>374x</i> |
|---|-------------|
| <i>Local phonebook (250 contacts)</i> | <i>X</i> |
| <i>Central phonebook</i> | <i>X*</i> |
| <i>Company phonebook</i> | <i>X</i> |
| <i>Vibrator</i> | <i>X</i> |
| <i>Headset connector</i> | <i>X</i> |
| <i>Microphone on/off during call</i> | <i>X</i> |
| <i>Loudspeaking function</i> | <i>X</i> |
| <i>SMS (Short Message Service)</i> | <i>X*</i> |
| <i>Voice mail access</i> | <i>X*</i> |
| <i>Centralized management</i> | <i>X*</i> |
| <i>Procedure call</i> | <i>X</i> |
| <i>Telephone restrictions</i> | <i>X</i> |
| <i>Easy replaceable battery (for 3740 telephones only)</i> | <i>X</i> |
| <i>Bluetooth for 3749 phones (for 3749 telephones only)</i> | <i>X</i> |

** System dependent*

Note: Your unit may have more functions than described here; see *User Guide, Avaya 374x DECT Telephone*.

Basic functions

Switch the telephone on/off

Press and hold the **On-Hook** key  until pop-up question is displayed.

Make a call

Dialling can be made in the following ways:

- In idle screen, dial the number and press the **Off-hook** key .

- Press the **Off-hook** key  and enter the number.
- Press a pre-programmed Hot key* or Soft key.
- Dial a number from the local phonebook. Enter the Contacts menu, select **Call contact** and select the name

from the list, press **Call** or the **Off-hook** key .

- Dial a number from the Central phonebook. Enter the Contacts menu, select **Central phonebook > search by name/number/last result**, and press **Search**. Press **Off-hook** key .

* *The alpha-numeric keys can be programmed with a telephone number.*

Answer/End a call

When the ring signal sounds; press the **Off-hook** key  to answer.

To end the call, press the **On-hook** key .

Turn loudspeaking function on/off

During a call, press the left Soft key to turn the loudspeaking function on/off.

Turn audio signals on/off

In idle mode a long press on the **Sound off** key changes between audio signals on/off. The **Sound off** icon  indicates a completely silenced telephone.

- A short press on the **Sound off** key before answering a call, silences the ring signal.

Lock/Unlock the keypad manually

Press the -key to lock/unlock and then Soft key **Lock/Yes**. The **Locked keypad** icon  indicates a locked keypad.

Change the volume during a call

Press the Volume button upwards to increase the volume, downwards to decrease the volume. Or, use the Navigation key to adjust the volume.

Charge the battery

Charging is done in a desktop charger or in a charging rack. Charging is indicated by orange LED. When the battery is fully charged the LED is green and a fully charged **Battery** icon  is displayed.

While in a desktop charger the telephone is fully operational. The telephone does not vibrate in charger.

The battery can also be charged in a separate battery pack charger.

Note: Charging below 5°C will harm the battery and shorten the lifetime.

Remove the battery

It is recommended to switch off the telephone before removing the battery.

Messaging



Receive a text message

When a text message is received, the LED starts flashing and a message tone sounds. A pop-up **New message(s):1 View now?** is displayed and the Soft keys **Yes/No** to read

the message now or later. The message is then stored in the message list. The **New message** icon  is shown in the display.

If the message is received during a call, the user is notified by a beep.

Read a stored message

Open the Message list, either from the messaging menu or by pressing the Navigation key  in Idle screen. Use the Navigation key  to navigate in the Message list. Select message and press the soft key **View** to read the message.

Send message

Open the Messaging menu , and select **Write new message**. Enter text, press the soft key **Send**, and then enter a number, or press the middle soft key for phonebook look-up. Press **Send**.

Delete a stored message

To delete a message, select message and press the soft key **More**, select **Delete**, and press the soft key **Yes**.

Check voice mail

A new voice mail is indicated by a pop-up and the  icon. Only one voice mail at the time will be displayed in the message list.

Open the **Messaging** menu, select **Inbox**, select , press the soft key **View**, and press **Call**.

or

A long press on digit key **1** will call your voice mail. If the extension number is not available a pop-up **Voice mail number not defined** is displayed. See *User Guide, Avaya 374x DECT Telephones*.

Menu

For descriptions of all functions; see *User Manual, Cordless Telephone 374x*.

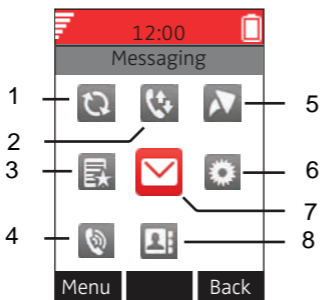

Figure notes:

- | | |
|------------------|---------------|
| 1. Connections | 5. Short cuts |
| 2. Calls | 6. Settings |
| 3. My favourites | 7. Messaging |
| 4. Profiles | 8. Contacts |

Navigate the menu

Use the Navigation key to move around in the menu structure.

The three Soft keys below the display are used for choices in the menu. The function of each Soft key is explained by text in the soft key field in the display.

Use the local phonebook

To find and call a name: Enter **Contacts** , step to **Call contact** and press **Select**. Enter the first letter in the name or the whole name (will be displayed in Search field while

entering text), or step in the contact list. Select the name and press **Call**.

To edit the contact: Select **Edit contact**, select the name and press **Edit**. Make your changes, press **OK** and then press **Save**.

To add a contact, select **Add contact**, select **New** or **From call list**. Press **Add**, enter the name and press **OK**. Select **Number**, enter the number, press **OK** and press **Save**.

To delete a contact: select **Delete contact**, select the name, press **Delete**, and then press **Yes**.

Use the central phonebook

Enter **Contacts** , and select **Central phonebook**. Select **Search by name**, **Search by number**, or **Last result**. Enter the first letter(s) in the first name, and/or the first letter(s) in the family name. Press **Search**. The Central phonebook will be searched and a list of matching names will be displayed. You can step to the next entry in alphabetic order by pressing the Navigation key. Press

More to add contact, or press **Call** or the Call key  to make the call.

Use the company phonebook

The company phonebook has to be imported via the PDM before it will be visible in the handset. See *User Manual, Cordless Telephone 374x*.

Enter **Call list**. A contact from the company phonebook is marked with the  symbol. Select name/number and press **Call**, only work number is available for the contact and it is not editable.



Soft keys, Hot keys and Multifunction button

The three Soft keys below the display can be defined for specific functions such as dialling a specific number. A long press on a Hot key can have the same function as a Soft key and any key **0**, **2 - 9** can be programmed as a Hot key. The Multifunction button can also be programmed for different functions with the use of long press and double

press.

For more information about Soft keys, Hot keys and Multifunction button, see *User Guide, Avaya 374x DECT Telephones*.

Turn the automatic keypad lock on/off

Enter **Settings** , and step to **Locks**. Select **Automatic key lock Off/On**, select **On/Off**, and press **Back**. A locked keypad is indicated by the **Key lock** icon .

To unlock, press the key , and then the Soft key **Yes**.

Accessories

The following accessories for the Avaya 374x DECT telephone are available:



Leather casing incl. belt clip



Belt clip, swivel type



Desktop chargers

Also available:

- Rackmount Charger
- Multiple Battery Charger only for 3740 DECT telephones
- Headset Mic on boom
- Peltor hearing protection headset

Index

A

| | |
|-----------------------------|--------|
| Accessories | 22, 35 |
| Admin Menu | 86 |
| Alphanumeric keys | 34 |
| Antenna | 25 |

B

| | |
|-----------------------------|--------|
| Battery | 26, 91 |
| charge | 91 |
| full battery icon | 29 |
| low battery icon | 29 |
| Belt Clips | 35 |
| Bluetooth headset | 59, 95 |
| calling | 98 |
| enable | 96 |
| pairing | 97 |
| verified types | 96 |

C

| | |
|---|----|
| Call answering | 49 |
| Call back | 54 |
| Call declining | 49 |
| Call diversion | 65 |
| Call info | 37 |
| Call list | 63 |
| Call Services | 65 |
| Call Waiting | 55 |
| Calling | |
| call a number from the call list | 49 |
| dial a number | 50 |
| quick call by a name in the phonebook | 51 |
| Calls | |
| menu tree | 37 |
| Case | 25 |
| Central phonebook | 73 |
| Charger | 26 |
| disconnnet telephone | 27 |
| telephone behaviour | 61 |
| Chemical resistance | 19 |
| Clip | 26 |
| Company phonebook | 73 |
| Conference Call | 54 |
| Connections | |
| menu tree | 43 |
| Contacts | 73 |
| menu tree | 39 |

D

| | |
|------------------------------------|----|
| Dispose of old equipment | 14 |
| Divert Calls | 65 |
| DTMF | 55 |

E

| | |
|--------------------|----|
| Earpiece | 25 |
|--------------------|----|

F

| | |
|---------------------------|----|
| Favourites | 67 |
| menu tree | 42 |
| Frequency range | 16 |

H

| | |
|-----------------------------|----|
| Handsfree key | 24 |
| Headset connector | 24 |
| Hot keys | 33 |

I

| | |
|-------------------------|----|
| Icons | 29 |
| Idle mode | |
| date | 28 |
| time | 28 |
| user identity | 28 |
| In Call | |
| menu tree | 45 |

K

| | |
|---------------------------|----|
| Key sound | 76 |
| Keypad lock key | 33 |

L

| | |
|------------------------|--------|
| Language | 80 |
| Lock/unlock | |
| keypad | 47 |
| telephone | 48 |
| Loudspeaker | 25 |
| Loudspeaking | 29, 49 |
| icon | 29 |

M

| | |
|--------------------------------|--------|
| Man-down Alarm | 83 |
| Menu icons | 31 |
| Message | |
| new message | 29, 57 |
| old message icon | 29 |
| receive | 57 |
| send | 57 |
| voice message icon | 29 |
| Messaging | 68 |
| menu tree | 41 |
| Microphone | 26 |
| on/off | 52 |
| Missed calls list | 64 |
| Multifunction Button | 33 |
| Mute button | 34 |

N

| | |
|---------------------------------------|----|
| Navigation/Confirmation key | 32 |
| No-movement Alarm | 83 |
| Number input mode | 34 |

O

| | |
|---------------------------|----|
| Off-hook key | 32 |
| On/Off key | 32 |
| On-hook key | 32 |
| Operating area | 90 |
| Out of coverage | 90 |

P

| | |
|------------------------------|----|
| Personal phonebook | 73 |
| Phone lock | 77 |
| PIN code | 77 |
| Procedure Call | 85 |
| Profiles | 72 |
| menu tree | 40 |

Q

| | |
|---------------------------------|-----|
| Quick Reference Guide | 103 |
|---------------------------------|-----|

R

| | |
|------------------------|----|
| Ring signals | 76 |
| Ring volume | 75 |

S

| | |
|------------------------------|---|
| Safety Information | 9 |
|------------------------------|---|

| | |
|-----------------------------------|----|
| Settings | 75 |
| menu tree | 44 |
| Short cuts | 66 |
| menu tree | 42 |
| Signal strength icon | 29 |
| Sound off button | 34 |
| Special characters | 57 |
| Switch between Calls | 53 |
| Switch telephone on/off | 47 |
| System | |
| change | 60 |
| subscribe | 60 |
| unsubscribe | 61 |

T

| | |
|---------------------------|-----|
| Text input mode | 35 |
| Transfer Call | 54 |
| Troubleshooting | 88 |
| Bluetooth | 101 |

V

| | |
|--------------------------------|----|
| Vibrator | 76 |
| Voice mail | 58 |
| key | 32 |
| Voice quality | 90 |
| Volume | |
| adjust during a call | 52 |
| button | 33 |
| ringer | 75 |
| speaker | 25 |

W

| | |
|-----------------------------|----|
| Writing Text/Numbers | |
| add space in text | 35 |
| pause | 34 |
| upper/lower case | 35 |
