



Engine

Make	Kubota
Model	1505 Stage V
Cylinders	4
Fuel type	Diesel
Cylinder volume cm ³	1498
Cooling system	Fluid

Power

SAE, gross power kW/hp	18,5/26
Max gross torque Nm	93
At engine speed r/min	1700
Max engine speed without load r/min	2300

Electrical system

Battery V-Ah	12-53
Generator A	40

Service volumes

Cooling system l	6
Engine oil l	5
Fuel tank l	20
Hydraulic tank l	45
Hydraulic system total volume l	50

Performance

Lifting power hydraulic kg	2100
Breakout force 50 cm kg	1500
Tipping load, straight kg	1500
Tipping load, articulated kg	900
Operating weight kg	1790
Drive speed low km/h	0-9
Drive speed high km/h	0-20
Pulling force high kg	800
Pulling force low kg	1550

Hydraulic system

Working hydraulics l/min	(18+32) 50
Engine speed rpm	2300
System pressure bar	240
Drivetrain hydraulics l/min	85
Drivetrain max system pressure bar	350

Cycle times

Raising boom s	4,2
Lowering boom s	2,6
Folding in bucket s	2,9
Tipping bucket s	2,2
Steering wheel rotations L/R rev	4/5

Tires

Dimension	320/55-15 TR
-----------------	--------------

Quiet and strong

The new a 7240 is replacing our a 7236. It will come with an upgraded engine fulfilling the requirements of Stage V. It will be strong, quiet, and more environmentally friendly. The new engine also makes vibration lower.

The pulling force has been improved to an impressive number of 1550 kg. Due to the redesign of the hydraulic system, the boom function is faster at lower rpms, which gives a smoother and more silent work mode with lower fuel consumption.

The a 7240 has dual working hydraulic pumps and can be used together with all the same attachments as the a 7236.

Norcar a 7240 is based on the same platform as the precursor, the a 7236, and will be compatible with all optional extras found on a 7236. This means that all the same optional extras, such as comfort cabin, AC, and so on, will be available for the new machine.

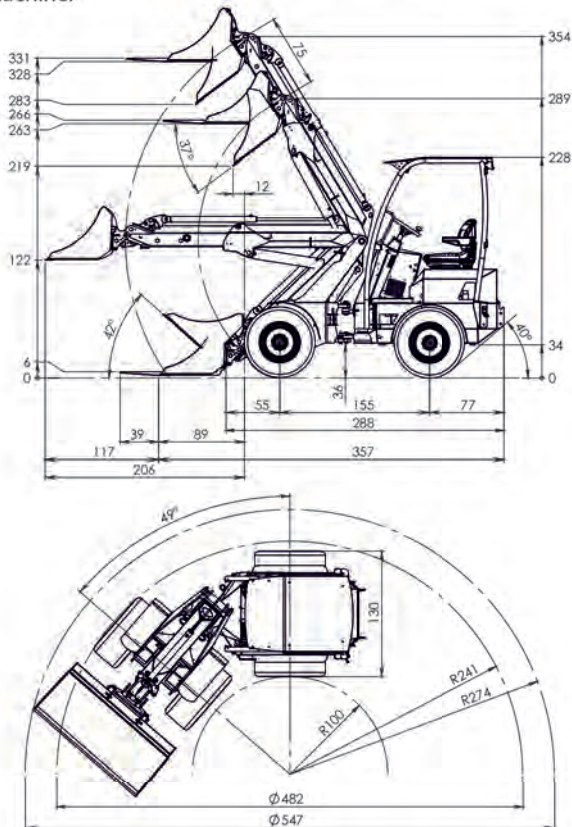

3540 mm	26 hp	0-9 km/h 0-20 km/h
---------	-------	-----------------------



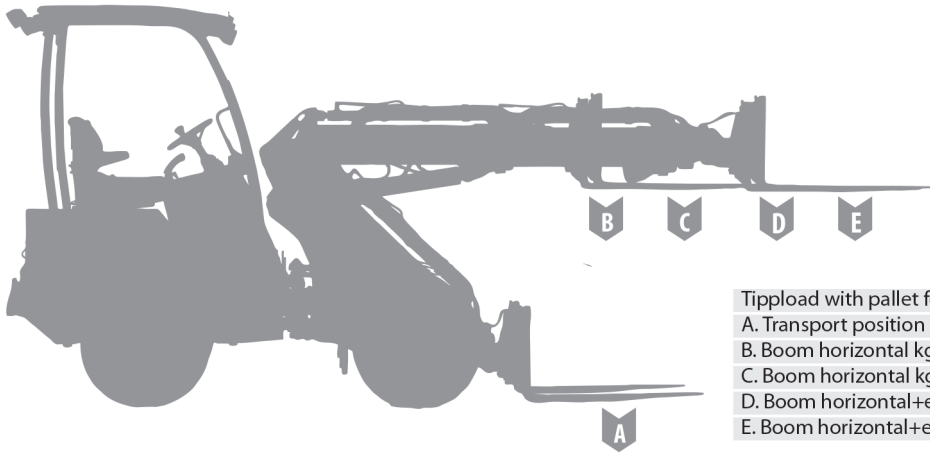

	Standard machine		+extra weight 270 kg	
Tipload with pallet fork	Straight.....	Articulated	Straight	Articulated
A. Transport position kg	1170	940	1500	1360
B. Boom horizontal kg	1500	1025	1670	1450
C. Boom horizontal kg	1010	700	1500	1050
D. Boom horizontal+extension 745	540		1070	760
E. Boom horizontal+extension 675	450		930	630

Standard equipment a7240

Roll bar ROPS/FOPS, seatbelt
 Working lights, front
 Electrically maneuvered parking brake/safety system
 Float on the lifting boom
 Hand throttle/Foot throttle
 Engine speed and hour meter, engine heat and fuel level gauges
 Suspension seat with armrest
 Adjustable steering column
 ProDrive



MultiFaster Quick release coupling
 The MultiFaster Quick release makes changes of hydraulic tools easy and quick. All the hydraulic connections are completed with a simple hand motion and makes it impossible to cross connect. Pressure is automatically released and no oil will leak.



Telescope Extension Boom
 750mm telescope boom gives good lifting height and reach. Electronically controlled using lifting boom's joystick.



Parallel leveller
 Keeps equipment in the set position regardless of the boom's movements. Increases safety and precision during lifts, especially with pallet forks.



Hydraulic Outlet, rear, single
 Single acting hydraulic outlet (R2) and free return (R3). Controls hydraulic attachments directly with joystick buttons. Rear hydraulic outlets should not be connected at the same time as hydraulic outlet, front. Hydraulic oil flow max 57 l/min.



Hydraulic Oil Cooler
 Maintains hydraulic oil's temperature at correct level while operating tools that require high oil flow during long driving periods.



High Capacity Hydraulics
 Dual working hydraulic pumps provide selectable flow (18/50 l/min) for hydraulic outlets. Telescope extension boom and external hydraulics work independently of each other, regardless of the boom's movements.



Two Speed Ranges
 Change between pulling force and speed. Low gear: 0-9km/h, pulling force 1550kg High gear: 0-20km/h, pulling force 800kg.



Tire 320/55-15 TR
 Tractor patterned tire. Provides good traction and is suitable for softer surfaces such as soil, sand, and gravel. Tread pattern is designed to keep the tire clean while driving on wet surfaces. Machine width 127 cm.



Traction control
 Provides better traction on slippery or uneven surfaces. Traction is guaranteed on the same side wheels.



FOPS Protective Roof
 Steel roof that protects the operator from falling objects.



Load Warning System
 Load warning provides a good overview of load weight and warns of the risk of tipping. The load warning can easily be calibrated to different counter weight alternatives.

Extra equipment a7240



Full traction control
Provides continuous traction on all wheels, regardless of terrain.

7004567



Oscillation lock
Locks the loader's pendular movement in the joint. Can be used during eg. leveling tasks when the tool needs to be parallel to the rear wheels.

7004619



Automotive
Automotive drive system allows the operator to change direction using a control switch on the loader's joystick. The loader is easy to operate and especially suitable for loading, janitorial jobs and when there's a need for driving longer distances.

7007180



Tire 27x8,5-15 IN
Durable multi-purpose tire that can withstand heavy loads. Suitable for work on harder surfaces such as asphalt, concrete, and hard packed gravel. Machine width 105 cm.

7006083



Tire 320 55-15 GR
Densely patterned tire. Soft tire that is gentle to surfaces and grips well. Suitable for work on grass, gravel paths, and roads. The tire is also good on snow and ice. Machine width 127 cm.

7004565



Tire 320/60-12 TR
Durable, tractor patterned tire that can withstand heavy loads. Suitable for work on hard surfaces but also gives good traction on soft ground. Machine width 127 cm.

7004563



Tire 400/45-15,5 IN
Specially designed for grass and sensitive ground conditions. Flexible for both soft and hard surfaces. Machine width 142 cm.

7006348



Extra Hydraulic Outlet, front
Electrically operated double-acting hydraulic outlets (4 and 5). Provides the ability to control several hydraulic functions on attachments directly with buttons on the joystick. Hydraulic oil flow max 18 l/min.

7004571



Hydraulic Outlet, rear
Double acting hydraulic outlet (R1)(R2) and free return (R3). Controls hydraulic attachments directly with joystick buttons. Rear hydraulic outlets should not be connected at the same time as hydraulic outlet, front. Hydraulic oil flow max 50 l/min.

7004573



Hydraulic Quick Lock
Change attachments quickly and easily without leaving the driver's seat.

7004569



LED Work Lighting
Work lighting with efficient LEDs. The lighting package contains seven LED fixture mounted forward, back and on the sides of the top of the roll bar, and a fixture attached to the front end to provide effective lighting for the attachment.

7006038



Traffic Equipment
Lights and equipment necessary for driving on public roads. Inspection and registration is required for driving on public roads and can vary between countries. Consult your dealer for advice regarding inspection in your region.

7004578



Rear View Mirrors
Rear view mirrors mounted on each side of the loader provide a comfortable and secure drive.

7004582



Rear Working Lights
Effective lighting, mounted at the back of the protective cage.

7004584



Beacon Light
Warns surroundings of working vehicle.

7004576



Mounting Plate for Counter Weight and Hitch
Mounting plate for attaching hitch, along with space for 4 x 45 kg extra weights.

7004609



Hitch
Hitch with standard 50 mm ball. Mounting Plate 7004525 needed for installation.

7004611



Hitch Combo
Hitch with standard 50 mm ball combined with pin for trailer towing eye. Mounting Plate 7004609 needed for installation.

7004613



Counter Weight 45 kg
Increases the machine's stability during handling of heavy loads. Easily installed without tools on Mounting Plate 7004609. Max 4x (180kg).

7004615



Counter Weight Bracket
Handy and compact counter weight for a-series loaders. The counterweight's and accessories' bracket is installed easily with a bolted connection on the chassis.

7008284

a7240

**Counter Weight 29 kg**

Counterweights are selected as needed and locked in place with a through bolt. The counterweights are designed with lifting points and notches in order to facilitate manual handling. Mounting on bracket 7008284. Max 12 (365 kg).

7008285**Counter Weight System**

Combination of 7008284 and 7008285. Recommendation for a7240, eight to twelve pieces.

7004586**Engine Pre-heater**

Improves starting ability and decreases wear during cold starts. Recommended plug-in time 30 min.

7004574**Windshield**

Protects against flying debris when working, for example, with flail shredder, hydraulic hammer, or snow blower. Windshield wipers and washer included.

7004586**Generator 60A**

A more effective generator for machines with high power consumption. Recommended for machines with traffic equipment and cab with heat.

7004621**Catalyst****7006396****Comfort seat**

Designed with a low-profile mechanical suspension that significantly reduces vibrations. Weight adjustment range 50-170 kg. Adjustable or foldable armrests, Backrest extension.

7006830**Seat Heater**

Heat in the seat's sitting part increases comfort when driving in cold weather.

7004605**Seat Heater, Comfort seat**

Heat in the seat's sitting part and backrest increases comfort when driving in cold weather.

7006831**Bottom Armour**

Steel plate mounted below the engine and front frame, protects the machine when working in difficult terrain.

7004607