

The Anatomy of Conical Helices,
Consciousness, and Universal
Constants

Author:

Jeffrey S. Keen

BSc Hons ARCS MInstP CPhys MBCS MIMS CEng

© 2006 by Jeffrey S Keen

All rights reserved. No part of this article may be reproduced, stored in a retrieval system, or transmitted or translated in machine language in any form or by any means, electronic, mechanical, photocopying, recording or otherwise, without the prior written permission of the author.

The Anatomy of Conical Helixes, Consciousness, and Universal Constants

Abstract

As rotation is an important feature of the universe, preliminary evidence suggests that its study could help in understanding consciousness. Research detailed in this paper further develops the author's work in Reference 1, with particular emphasis on fields perceived to be displaying a spiral nature. Numerous quantitative properties of these fields are detailed, and as often found in scientific research, the results spring several surprises.

The study of spirals and vortices results in relationships with high correlation coefficients, together with universal constants that occur in other disciplines in science. These facts not only reinforce the validity of the research techniques being adopted, but also further the quest in understanding consciousness and the structure of the universe. The conclusions suggest that vortices are not only involved in consciousness, but also have wider implications in understanding our universe, and therefore the subject warrants further research.

Objectives

Rotation of objects in orbit, or the spin of objects around their axes seem to be an important property of the universe at whatever scale one chooses – be it rotating galaxies, planets revolving in solar systems, planets spinning on their own axes, electrons spinning around nuclei of atoms, or the spin associated with fundamental particles. The latter particles that carry the fundamental forces of nature, such as the photon and the gluon are bosons, which have integer spin, whilst the quarks and leptons that make up matter are fermions, which have half-integer spin ($1/2$, $3/2$...). The objectives of the research described in this article are to further the author's quest in the study of consciousness, its connection with spin/vortices, and the mind's interaction with the structure of the universe.

Scope

For thousands of years, numerous civilisations around the world have been aware of “spiritual aspects”, “earth energies”, “auras”, and other sensations that are not yet detectable by instrumentation. As will become apparent, studying these subjects, and using this approach to scientific research, may at first seem unusual, but is proving to be very productive in the study of consciousness. In this context, it will be demonstrated that dowsing is a useful, relevant, and powerful tool. In particular, “spirals”, as they are popularly known, the subject of this paper, are one of the most common features detected when on-site dowsing, and in the study of earth energies.

Spirals appear in numerous diverse places; in fact anywhere on, above, or under the Earth's surface. Set out below are some examples of where spirals are found.

1. Ancient sites and burial mounds.
2. Within the auras of solid bodies.
3. Over geological features, including underground intersecting watercourses.
4. Inside substantial buildings.
5. Inside underground caves.
6. The mind can generate spirals anywhere.
7. The intersection of two dowsable lines produces a spiral.
8. Spirals terminate dowsable lines.

Findings Common to all Spirals, Irrespective of Source

All spirals seem to have the same structure, whatever their source. Elevations, plans, and cross-sections in the following diagrams, give a general indication of the geometry involved.

Plan View of an Anti-clockwise Spiral

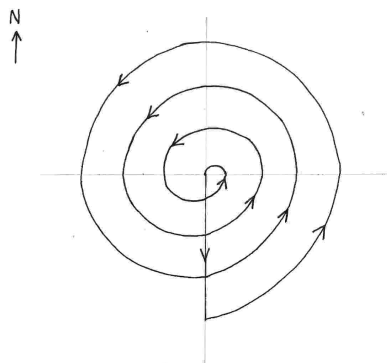

Figure 1

Figure 1 is a typical plan view of a spiral. Several features are immediately apparent. There is a perceived flow in an anti-clockwise direction. This seems to start from the centre of the spiral, flows in a straight line due south, and then makes a right-angled turn to start the spiral. The spiral finishes where it started, at the centre. Both clockwise and anti-clockwise spirals exist, which will be elaborated on later. The separation distance between adjacent turns of a spiral is approximately the same, implying that spirals are more closely arithmetic rather than geometric. Highly significant is that all spirals have $3\frac{1}{2}$ turns, and any line drawn through the origin always intersects the spiral at 7 dowsable points (the origin/centre is not a dowsable point in this context). These 7 points are approximately equally spaced apart so measurements form an arithmetic series. The fact that in some scales a harmonic octave has 7 notes is relevant.

Figure 2 is a typical side elevation view of a spiral. As is apparent, spirals are 3 dimensional. An observer tracing a spiral on the ground will initially perceive a pattern similar to figure 1. Only after further investigation will the observer realise that the “spiral” is not just 2-dimensional. As illustrated in figure 2, vortices/spirals are perceived to possess an outer conical envelope. Hence, the correct name for this phenomenon is not a *2-D spiral*, but a *3-D conical helix*. In fact, figure 1 is figure 2 projected on to the ground, or in other words, the intent of the observer in figure 1 is to look down and view the conical helix from above its central axis. It is now

possible to understand the flow pattern initially perceived in figure 1. This flow starts at the apex of the cone, and goes vertically upwards, along the central axis of the cone. On reaching the base of the cone it flows due south along a horizontal radius until it reaches the edge of the cone. It then descends with $3\frac{1}{2}$ turns back to the apex.

Side Elevation View of an Anti-clockwise Spiral

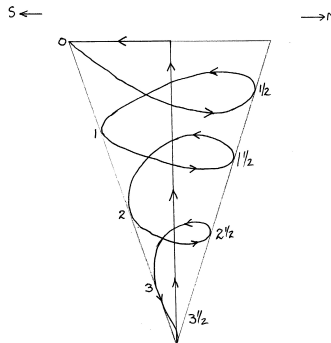

Figure 2

Figure 3 is a typical cross-section view of a conical helix, where the cross-section is a vertical north-south plane through the central axis. In figure 2 the observer is viewing from the outside, whilst in figure 3 the view is from the inside. Both figures depict the same helix. For an anti-clockwise helix the flow of the helix on the left hand side of the cone is coming out of the paper, and the perceived flow goes into the paper on the right hand side.

Cross-Section View of an Anti-clockwise Spiral

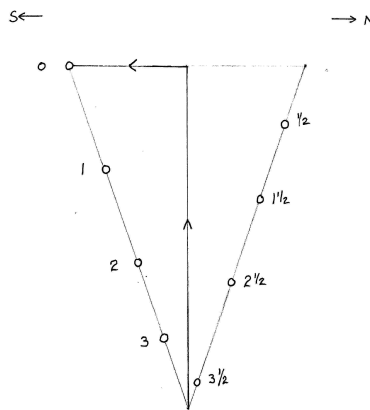

Figure 3

Figures 4, 5, and 6 are identical to figures 1, 2, and 3 except they depict a clockwise spiral. An important difference between the two spirals is that the flow along the vertical axis of an anti-clockwise helix is nearly always upwards which naturally leads to the downward flowing helix. However, the vertical flow along the cone's axis is nearly always downwards for a clockwise helix and leads naturally to the perceived upward flowing helix.

Plan View of a Clockwise Spiral

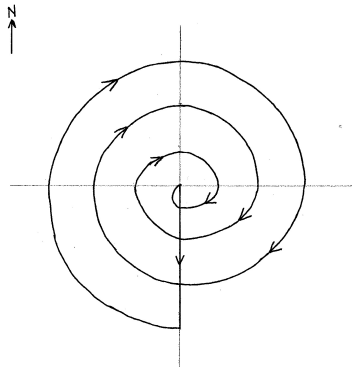

Figure 4

Side Elevation View of a Clockwise Spiral

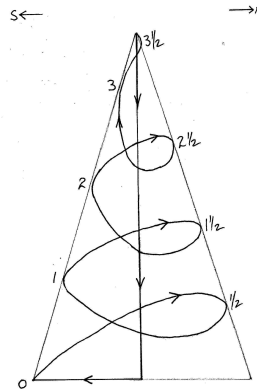

Figure 5

Cross-Section View of a Clockwise Spiral

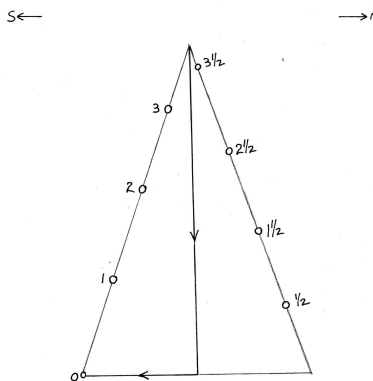

Figure 6

A fundamental feature is that most “spirals” seem to comprise two linked conical envelopes. Conceptually, these two cones are linked apex to apex, with an X-shaped cross-section. The top cone points down whilst the bottom cone points upwards; in other words figure 2 sits on figure 5, as in figure 7. As is apparent, passing through

the touching apexes is a horizontal plane of symmetry; the lower conical helix is a mirror image of the top one. Looking down, if the top spiral is anti-clockwise, the bottom is clockwise, and vice versa. Upper cones have a propensity for a perceived anti-clockwise downward flow, whilst the lower cones have a clockwise upwards flow. There is no evidence of a connection between the top and bottom flows – they seem to be independent reflections. Being reflections, the cones have the same sizes, and in particular, the diameter of the base of the top cone equals the diameter of bottom cone's base.

Side Elevation View of a Pair of Conical Helices

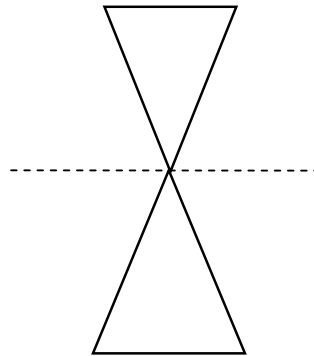

Figure 7

For those cases where the top cone is clockwise, figure 8 illustrates the flow when looking down. It has the same orientation as figure 1, but an opposite flow.

Plan View of a Top Clockwise Spiral

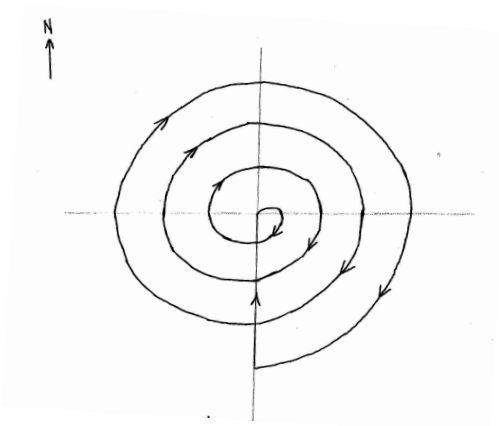

Figure 8

To avoid confusion, it is important to adopt two practical conventions. The first is when visualising conical helices, the viewer should, by convention, always be looking down (ie along the direction that gravity is pulling). The second convention is that the definition of whether a conical helix is upward or downward depends on the perceived flow of the spiralling part of the helix, not the upwards or downwards perceived flow along the vertical axis. The obvious reason for these two arbitrary conventions is that

an observer whose intent is to visualise conical helices standing on the ground looking upwards, will perceive the opposite flow to an observer looking down.

As always in science, when some one believes they understand a subject, subsequent new data can lead to new insights. Having determined that “spirals” are really a pair of conical helices, on further investigation it is discovered that “spirals” are more accurately a series of seven pairs of conical helices, stacked vertically, one on top of each other, sharing a common axis. Acknowledgements are due to Bob Sephton for bringing this to the author’s attention. This is depicted in figure 9, where the column can be erroneously construed as a series of diamond patterns, not as reflections of pairs of cones of the same size and the same separation.

Side Elevation View of a Series of 7 Conical Helices



Figure 9

Traditionally, people associate perceived upwards spirals as positive, beneficial, or “healing”, whilst downwards spirals are negative or associated with, say, burials. This presents a challenge because the findings of the research described in this article suggest that all spirals have both an upwards and downwards component. A possible explanation is that there is a scientific phenomenon to be discovered, whereby the bottom upwards cone is dominant for a positive spiral, and the top downward spiral is dominant for a negatively perceived spiral. Alternatively, the positive or negative sensation could all be in the observer’s mind depending on whether the observer’s intent is focused on the top or bottom conical helix. This could be a possible subject for further research.

As is apparent, every conical helix has a vertical axis. This suggests that gravity is a fundamental factor in the production of conical helices.

What spirals have in common is that they are all Type 3 fields (reference 1, page 227). Unlike other types of dowsable fields, they and their source, are unaffected by light photons or electromagnetic fields in general, and are not diminished by a Faraday Screen, or attenuated by being enclosed in by a thick metal container. This and gravity will be discussed later.

Complexities of the Real World

To facilitate an introduction to the following more complex concepts, the previous sections were a simplified quantitative summary of the properties of the ubiquitous “spiral”. In the real world, there are additional complexities and perturbations, which are only discovered qualitatively, ie by the standard scientific method of measurement. Before proceeding any further, it may be instructive to examine the experimental techniques adopted, together with some of the locations where the research for this article was undertaken. To illustrate the diversity of the phenomenon of conical helices, and the extensiveness of the measurements undertaken, the author in his travels around the world has assembled on-site measurements, together with relevant supporting photographs, from the following situations and sources.

1. Part of the aura of a solid body comprises an outer series of spirals. In particular, the following crystalline solid objects were used in the experiments. 0.1grams of Quartz, 0.6g of Hematite, 4g of Quartz, 8g of Moss Green Agate, a Pebble weighing 34g, a piece of Granite weighing 1,090g, and an Amethyst of 4,425g.
2. A dowsable line terminates in a spiral. In this case, two interacting pebbles from a beach in Turkey created the line. (Reference 1, page 110)
3. Man-made prehistoric sites are a well known source of spirals. In this case a series of spirals were measured that were created by the linear double dykes at the ancient site of Hengistbury Head (in Bournemouth, UK), and the rings of banks and ditches at Avebury.
4. Isolated spirals such as those associated with a burial mound at Hengistbury Head were analysed, as well as those at the centre of an ancient Greek temple, and an ancient Greek Offering Table at a different site.
5. A small vent near the summit of Mount Etna caused an isolated spiral.
6. At the centre of the Rollwright Stones, there is a spiral possibly caused by underground intersecting watercourses.
7. Spirals created by the geometry of a building’s architecture are very common. Examples used in this article include those in domed rooms in St Petersburg palaces; in the auditorium in the Kirov Theatre, and at the centre of Angkor Wat in Cambodia.
8. Domed chambers in underground caves generate spirals, and a study was made of one in Majorca.
9. The mind can generate spirals. (Reference 1, page 202). For the research described in this article, these were formed locally a few feet away, as well as created remotely 3,500 miles away from an aircraft at 32,000 ft.
10. The intersection of two dowsable lines generates a spiral. In item 2 above, two interacting crystalline stones created one dowsable line. In this extension of the experiment, the two lines were created in laboratory conditions by four stones, i.e. two pairs of interacting stones.

Several months were spent analysing data resulting from the above observations, and this has lead to some interesting results and conclusions. However, before detailing results, it is appropriate to describe the experimental techniques adopted, in order to encourage duplication of these experiments, and for others to confirm and refine the findings. This is good science.

Experimental Techniques

As already elaborated, nearly all spirals are 3-dimensional helices, which have conical envelopes. Seven basic measures helped to prove this conclusion.

1. Angle of Cone

A simple, but effective technique for measuring a cone's angle is to dowse for the vertical axis of the helix, and mark its location on the ground. After fixing a sheet of paper vertically above this mark (ie along the axis of the helix), a line may be drawn on the paper along the vertical axis. It is preferable (being faster and more accurate) to "device-less" dowse the envelope of the conical helix with a pencil, mark the cone on the paper, and hence draw the half-angle of the cone.

2. Diameter of the Base of Cone

The easiest way to dowse the size of the spiral (which more correctly is the diameter of the base of the cone), is by projecting the base of the conical helix on to a floor. The intent is to visualise looking down on the helix, thereby projecting the 3-dimensional helix as a 2-D image of a spiral on flat ground. The spiral can then be marked out.

3. The Height of the Cone

Usually, the height of the cone is either too high, or physically inaccessible to dowse directly. If so, calculating the cone's height by trigonometry is easily done using the radius of the base (half the diameter) and the half-angle of the cone as determined above. Alternatively, it can be measured by having the intent of turning the height of the cone through 90° , and projecting it on to level ground. This is analogous to "The Bishop's Rule" for measuring the depth of water – a century's old proven technique.

4. Spiral Turns

Whilst the plan of the spiral is projected on to the ground, it is possible to dowse the trajectory and flow of the spiral. Measurements can then be recorded of three more properties that are important. These are the number of turns of the spiral, the direction of the perceived flow, and the separation distances between the turns.

5. Orientation

When attempting to build up an accurate 2-dimensional and 3-dimensional model of spirals, it is essential to adopt more advanced measurements. This involves not only measuring distances and angles, but also their direction with respect to North. The easiest way to record orientation is to use a magnetic compass. Orientation is also important, when for example, measuring spiral diameters (as in point 2 above). Because of the shape of the spiral, its diameter varies in different directions.

Experimental Errors

A possible cause of experimental error may be inherent in the techniques being adopted. In particular:

- a) if the vertical plane of the sheet of paper on which the envelope of the cone is being drawn is not aligned to the precise axis of the spirals, a conic section (that is a parabola or a hyperbola) will result instead of a simple cone.
- b) If a magnetic compass is used, errors in the measurements will always occur due to magnetic variation from true north, or from interference from local steel framed buildings or magnetic objects. However, a sensitivity analysis demonstrates that in practice, this potential source of error is insignificant.
- c) Actual on-site measurements depend on error prone human dowsing sensitivity.
- d) In addition to on-site measurements, the effective technique of dowsing photographs was adopted. (Reference 1, page 236). Although theoretically this could be a cause of error, in practice, comparison of results between on-site and photograph dowsing showed no significant difference.

Quantitative Findings Common to all Conical Helices

Figure 10 summaries the results of observations of the conical helices associated with the sources detailed earlier. As is immediately apparent, all spirals have 3½ turns, with upper cones possessing an anti-clockwise downward flow, and a north-south radial entry. There was no difference between on-site or photograph measurements.

Upper Spirals and their Properties

Location	Source	Spin Direction	Number of Turns	Flow Direction	Entry Path
Mind from 3,500 miles - Actual	Actual	a/c	3.5	Down	N to S
Mind from 3,500 miles - Intent	Specified	a/c	3.5	Down	N to S
Quartz 0.1g	Actual	a/c	3.5	Down	N to S
Hematite 0.6g	Actual	a/c	3.5	Down	N to S
Mind - Local	Actual	a/c	3.5	Down	N to S
Line Termination (2 crystals 24g)	Actual	a/c	3.5	Down	N to S
Kirov Theatre	Photo	a/c	3.5	Down	N to S
Quartz 4g	Actual	a/c	3.5	Down	N to S
Moss Green Agate 8g	Actual	a/c	3.5	Down	N to S
Quartz 100g	Actual	a/c	3.5	Down	N to S
Mind - Remote 120 miles	Photo	a/c	3.5	Down	N to S
HH D/D Spiral - on-site	Actual	a/c	3.5	Down	N to S
HH D/D Spiral - photo	Photo	a/c	3.5	Down	N to S
Granite 1,090g	Actual	a/c	3.5	Down	N to S
Pebble 34g	Actual	a/c	3.5	Down	N to S
Domed Cave Floor - Majorca	Photo	a/c	3.5	Down	N to S
Amethyst 4,425g	Actual	a/c	3.5	Down	N to S
St Petersburg Palace	Photo	a/c	3.5	Down	N to S
HH Burial Mound	Photo	a/c	3.5	Down	N to S
Rollwrights - centre	Photo	a/c	3.5	Down	N to S
Mount Etna Vent	Photo	a/c	3.5	Down	N to S
Ancient Greek Offering Table	Photo	a/c	3.5	Down	N to S

Figure 10

In general research on spirals, there is often known and consistent perturbations, some of which are now briefly described. An analysis of the separation distances between the turns of one of these spirals is not straightforward. Errors could arise from

projecting inaccurately a 3-dimensional image to a 2-dimensional spiral on the ground. It also seems to affect the results, if the measurements are taken from the centre of the spiral, as opposed to the periphery; the challenge being to define the exact location of the origin of the measurements. There also seems to be anomalies in the measurements at the spiral's centre and at its edges. This is a common problem when taking measurements at nodal points of a dowsable field. Another complication is that often the cone is not symmetrical, with an elongated bulge in some directions. This subject obviously requires further research.

Figure 11 summarises the measurement of the turns of a typical spiral, which, in this case, was produced by two intersecting dowsable lines. These measurements were along one diameter of the spiral (with the origin in this case taken at the outer edge of the spiral), and suggest that the turns form an arithmetic (also known as an Archimedean) spiral, but with perturbations.

Turns of Spirals

Turns of Top or Upper Conical Spiral Projected on to the Ground			
Points on a Diameter n	Distance from Periphery metres	$(n+1) - n$	$(n+1)/n$
1	0.000		
2	0.390	0.390	2.033
3	0.793	0.403	1.440
4	1.142	0.349	1.247
5	1.424	0.282	1.157
6	1.648	0.224	1.125
7	1.854	0.206	

Figure 11

Figure 12 gives an indication of the size of the spirals associated with the sources in figure 10. The smallest spirals are mind generated or from very small solids. The largest are from large domed architecture, large ancient sites, Earth energies, and volcanoes. This is only indicative of spiral diameters because each measurement was at different times of the day, on different days, on different months, on different years. As always, dowsable fields are constantly changing.

Some spirals, such as those covering an entire ancient site, can extend to over 100 metres. As these measurements require specialist equipment, they have not been included in the quantitative analyses of this article. However, their qualitative properties are similar to smaller spirals, possibly displaying properties of fractal geometry, i.e. the larger patterns being self replicating versions of the smaller ones, and vice versa.

Sources of Spirals and their Size

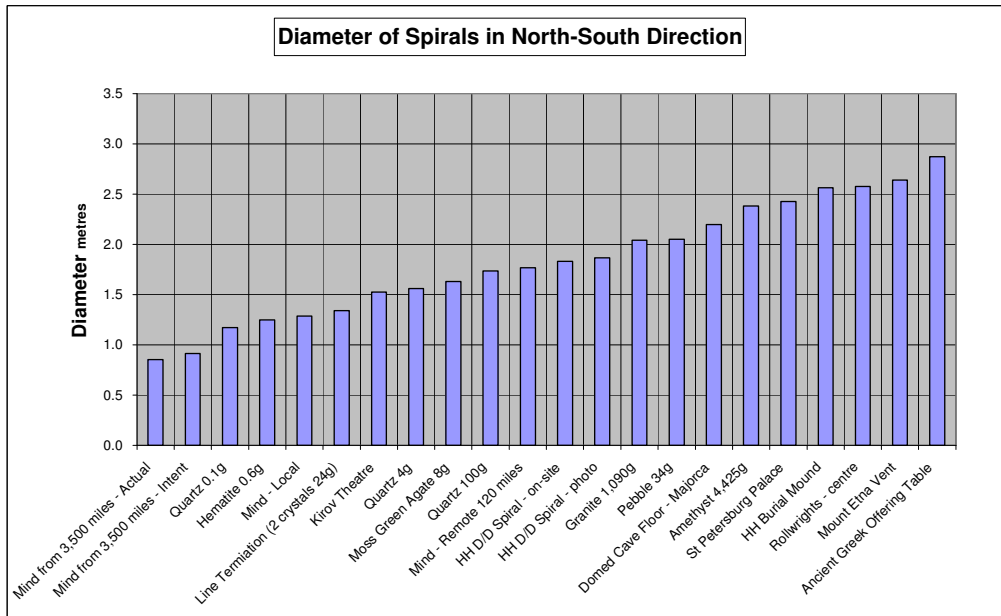

Figure 12

Polar Diagram of Spiral Turns

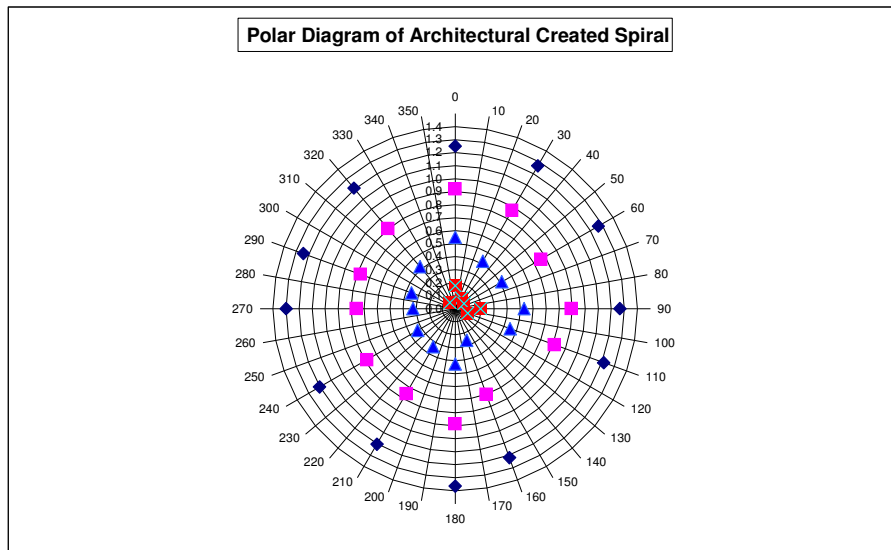

Figure 13

The limitation of analysing measurements such as those in figure 11 is that the measurements are in one dimension. As discussed earlier, the measurement of orientation is essential to study three-dimensional conical helices. This leads to the use of polar diagrams to represent results. As a result of extensive studies of polar diagrams it is found that, in general, all spirals look similar. The polar diagram in figure 13 was produced from taking measurements from a photograph of the spiral on

the floor at the centre of a large domed room in one of the palaces in St Petersburg, Russia. This polar diagram only gives a snapshot at specific co-ordinates; it does not give a continuous line. Figures 1, 4, and 8 gave an idealised interpretation of the geometry. Figure 14 traces the flow of the spiral, and is superimposed on the polar diagram in Figure 13.

As is apparent from figure 14, spirals are not always symmetrical. This also illustrates the importance of recording orientation with respect to north when taking measurements. As in all “earth energies” studies, there are the usual perturbations caused by the spin of the Earth on its axis, the rotation of the Earth around the Sun, the rotation of the Moon, and other cosmic activity. It is interesting to note that these causes of perturbations to dowsable fields are, in turn, caused by spin!

Spiral Turns and Flow

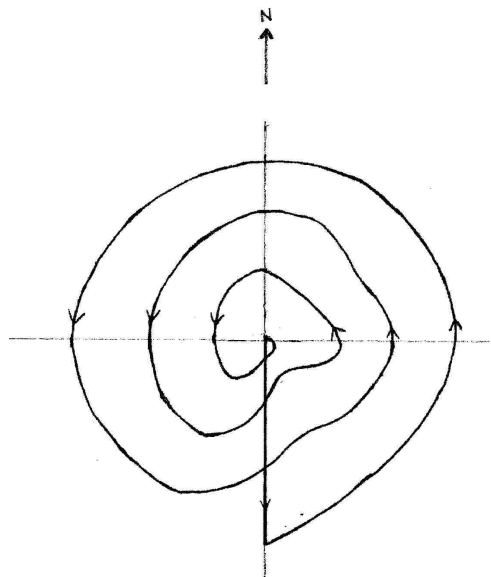

Figure 14

Figure 7 gave a conceptual illustration of a pair of conical helices with touching apexes. This was over simplified. In practice, the two cones are linked by an overlap of apexes as in figure 15. The overlap is asymmetrical, so that a vertical cross-section produces a trapezium shaped overlap area, with the left hand side often lower than the right.

Possibly, the perturbations causing asymmetry in figure 14 are the cause of asymmetry in figure 15. What seems to be happening is that the top and bottom helices are not only reflections of each other as explained earlier, but they seem to be precessing around each other like a wobbling spinning top, or the Earth on its axis. Further measurement reveals that the area of overlap depends on the orientation of the measurement, as illustrated in figure 16.

Asymmetrical Cone Overlap

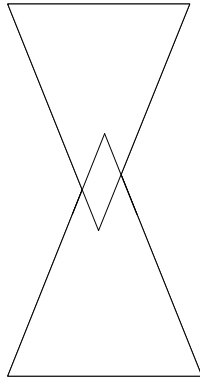

Figure 15

The Affect of Orientation on the Area of Overlap of Conical Spirals

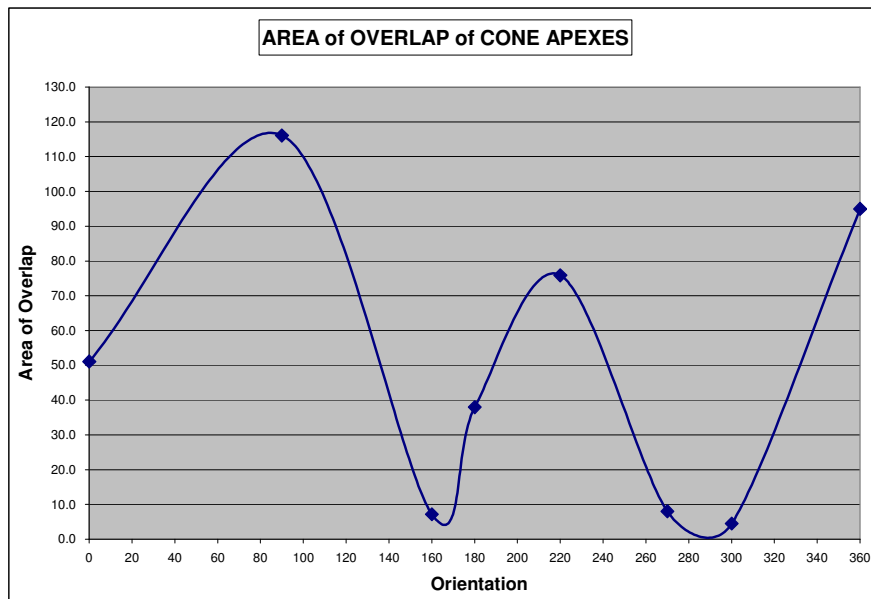

Figure 16

As is apparent from figure 16, the area of overlap is at a maximum when the measurements are to the East (90°), South-West (225°), and North (360°). They are at a minimum when the orientation is to the South (180°) and West (270°). These results are unexpected but very interesting. Another unexpected observation is that there is an anomaly, because the value at 0° is not identical to the value at 360° .

The Affect of Orientation on the Half Angles of Cones

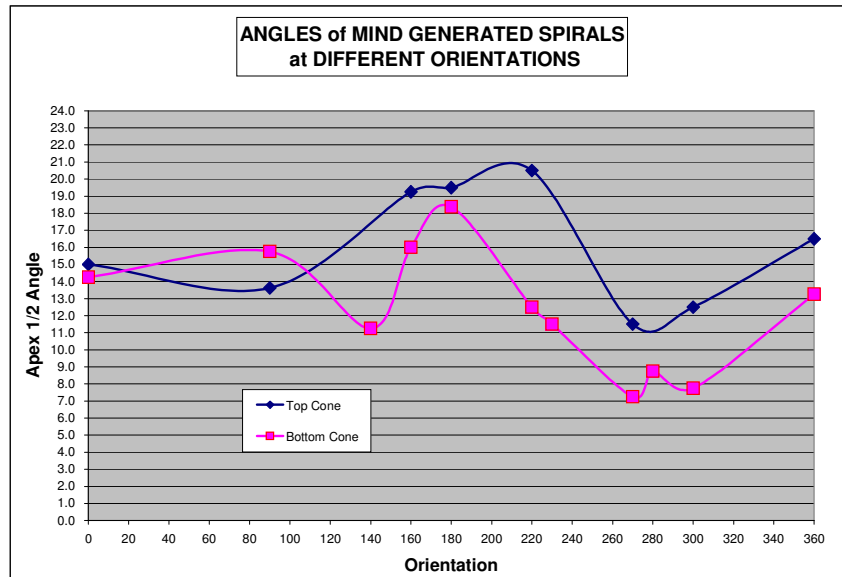

Figure 17

Figure 17 plots the half angle of a conical helix, which varies for different orientations. Maxima for both the top cone as well as the lower cone occur when the orientation is due south (180°). This is reassuring as it is consistent with the findings depicted in figure 1, which shows that the maximum diameter of the base of a conical helix is in the north-south plane, and hence the angle at the apex of the cone will be a maximum. A similar reason explains minima for both the top cone as well as the lower cone occurring when the orientation is due west (270°).

Allowing for experimental error, even more reassuring is that the maxima and minima occur at good approximations to the angles 19.471° , 11.537° , and 8.213° . These are key universal constants of angles with a sine of $1/3$, $1/5$, and $1/7$, and will be discussed in more detail later.

Non-Common Properties of Conical Helices

An earlier heading was “Findings Common to all Spirals, Irrespective of Source”. This section details those sources of spirals that generate some additional properties to those covered so far. In particular, we will examine auras of solid objects, series of spirals at ancient sites, and spirals at the intersection of two dowsable lines.

Series of spirals in auras of solid bodies

Auras from a solid body comprise a core aura, a series of ellipsoid fields, and an outer series of spirals that seem to extend to infinity in a straight line. (See reference 1, page 155). The relevance here is the latter outer series of spirals. As there is a plethora of findings, the summary below is numbered for ease of reference.

1. Figure 18 is a graph of how far away spirals are from their source. The distance of the first spiral from its source object is a function of the source's mass. The larger the mass, the further away are the associated spirals. There is a logarithmic relationship between the mass of a source object and the distance from its centre of its first spiral. This relationship has a quite high correlation coefficient (0.8). (A similar logarithmic relationship exists for the size of the source's core aura compared to its mass). Because of the logarithmic relationship, spirals generated by the heaviest objects are only approximately three times as far away from their sources, compared to the distances of spirals emanating from the lightest of source objects.
2. However, in figure 18 there is a significant anomaly at zero mass. Logically there should be no spiral, but the graph indicates there is one about 3 metres from a non-existent source! Physically, to what does this 3 metres relate?
3. The orientation of the source is irrelevant. The source object can be turned through 360° (either around a horizontal or vertical axis), but the locations of the spirals remains the same. The significance of this and the following point is discussed later.
4. There is similarly no difference in either the location or the properties of the spirals, if the source is rapidly spun.

Distance of First Aura Spiral from its Source Object

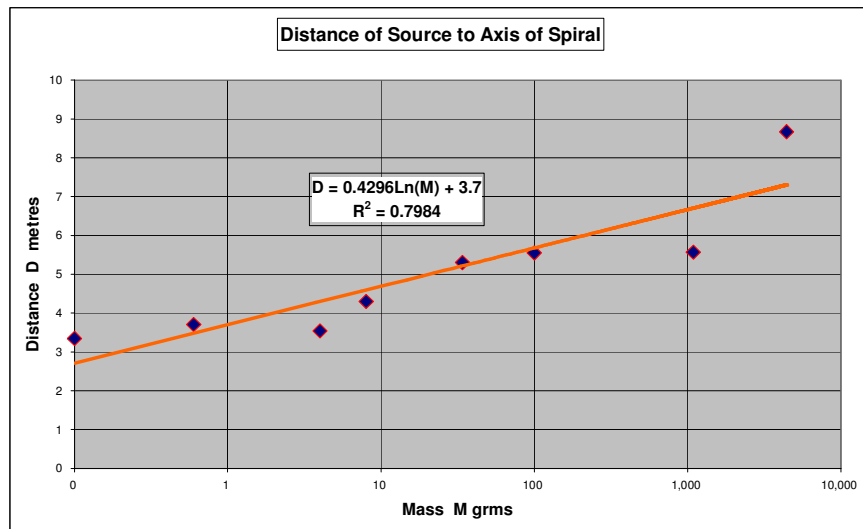

Figure 18

5. Figure 19 is a graph of the size of aura spirals compared to the mass of the solid body creating them. The larger the mass of the source object, the greater are the diameters of the bases of the associated conical helices. As before, there is a logarithmic relationship between the mass of a source object and the diameter of the spirals in its aura. This relationship has a high correlation coefficient (0.9). Interestingly, as a result of this logarithmic relationship, the diameters of spirals generated by the heaviest objects are only approximately double the size of spirals emanating from the lightest source objects.

Size of Spirals Created by Source Objects of Different Mass

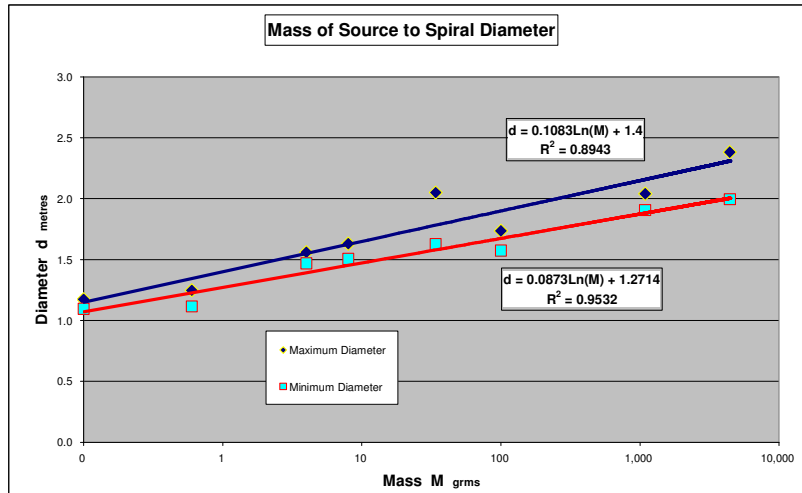

Figure 19

6. Once again, there is the anomaly of zero mass having 1-metre diameter spirals. There should be no spirals if there is no source to create an aura! Obviously, further research work is required to find the reason for this anomaly.
7. The apex $\frac{1}{2}$ angle of the series of conical helices associated with a solid source are an inverse function of the mass of the source. For example, for a source with low mass, the apex $\frac{1}{2}$ angle may be 30° , whilst for a relatively heavier source, this angle may be 20° . This is counter intuitive. If larger masses produce a larger diameter cone base, the apex angle would become shallower if the heights were constant. Presumably, the height of a cone having a heavy mass source is significantly higher than the height of a cone from a low mass source. Further experimentation is required to prove if this is true.
8. The series of spirals within auras start with the inner most top conical helix being anti-clockwise down, with the next one being clockwise up, and then alternating. Adjacent spirals are between 2-10 feet apart.

Series of spirals at ancient sites

Spirals at ancient sites possess the same properties common to all spirals but with the additional characteristic that they form a series of spirals if associated with banks and ditches. These series are similar to point 8 above; being alternate clockwise and anti-clockwise spirals, but they follow the contours of the banks and ditches that have created them. The separation distance between these adjacent spirals is usually between 100 - 200 feet apart.

Spirals resulting from the intersection of two dowsable lines

This section studies the spirals produced at the intersection of 2 simple dowsable linear fields (henceforth referred to as "lines"). To facilitate changing the parameters of experiments, two "artificial" man-made dowsable linear fields were created in

laboratory conditions. The apexes of the usual double conical helices meet where the lines cross. The special case of two lines at right angles, one vertical, and one horizontal is illustrated in Figure 20, which is the side elevation view.

Spiral Created by Two Intersecting Dowsable Lines

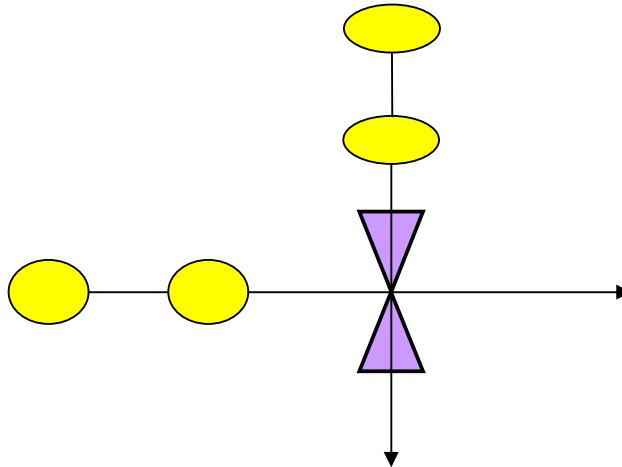

Figure 20

Although any 2-body interaction produces lines, it is convenient to use olive sized crystals or stones. In these laboratory conditions, it is possible to perform experiments that are impossible on-site. For example, both horizontally and vertically orientated lines were studied, and one of the objectives of the experiment was to change their angle of intersection.

It is found that the spirals are invariant to the orientation of the 2 interacting dowsable linear fields. In other words, a spiral with a **vertical** axis is formed if the 2 intersecting lines are vertical or horizontal, or any combination in between. This reinforces the earlier statement that gravity is involved in producing spirals.

The Effect of Intersection Angles on Spirals

Angle	Top	Cone	Bottom	Cone
90°	c/w	up	a/c	down
30°	c/w	up	a/c	down
12°	c/w	up	a/c	down
7°	a/c	down	c/w	up
5°	a/c	down	c/w	up
3°	a/c	down	c/w	up

Figure 21

Another significant finding is that conical helices are affected by the angle of incidence of the two lines that are forming them, as shown in figure 21. In particular, for small intersection angles, the top conical helix has an anti-clockwise downwards flow, as in the majority of spirals discussed so far. However, there is an interesting anomaly for larger angles of intersection: the top cone switches to being clockwise

with an upwards flow. As always, the bottom cone reflects the changing top cone. Is this an example of entanglement?

This has led to further experiments to determine the null intersection angle when the flow reverses. Figure 22 illustrates a method for measuring this null angle accurately, by the use of trigonometry. The two intersecting lines and the distance between the two rear stones form a triangle, the apex of which is the centre of the created spiral. Dropping a perpendicular from the centre of the spiral to the line joining the two rear stones, gives a right-angled triangle, the base of which is x , and the height is y . The intersection half-angle is θ , where **Tan $\theta = x/y$** . Theoretically, this experiment can be made very accurate by adjusting the four stones so that y is very long. However, in practice, y is very difficult to measure when there is no spiral in the null position!

As this experimental technique does not lead to an accurate answer, the upper and lower limits of the null angle of intersection ($2\theta^\circ$) between the two lines has been determined by a series of over 20 experiments leading to the following values:

- If $2\theta^\circ > 10.286^\circ$ the top cone is an upwards clockwise spiral
- If $10.286^\circ < 2\theta^\circ > 8.107^\circ$ no spirals are created
- If $2\theta^\circ < 8.107^\circ$ the top cone is a downwards anti-clockwise spiral

This result raises the obvious question as to whether there is any connection between arcsine (1/7), which is 8.213° , and the above null angle.

Another intriguing preliminary observation is that the flow of the helix part of the conical helix reverses at 8.213° , but the flow along the vertical central axis of the conical helix reverses at 11.537° (arcsine 1/5). Further experiments are required to verify this, and to explain what happens between these two angles.

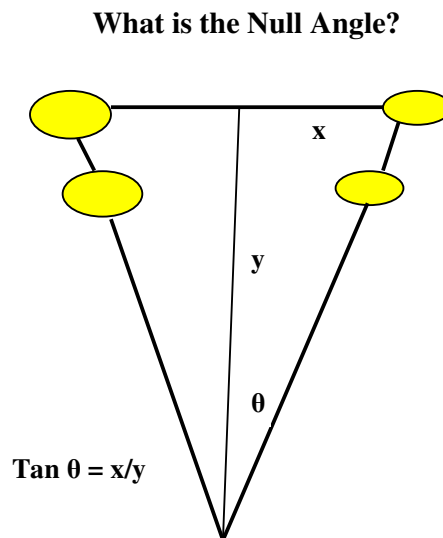

Figure 22

Conclusions

Even an enthusiastic reader may by now have become impatient and started to ask the question “so what?” What is the relevance of all these measurements of lines, spirals, arithmetic series, angles, spin, and gravity? Where does it all fit into the “big picture”? Fortunately, numerous fundamental conclusions can be drawn from the observations in this paper, and these are numbered below for ease of reference.

1. Adding to the weight of other relevant publications, this paper is a further confirmation of the power of using the technique of dowsing in the scientific study of consciousness. Our level of understanding of both dowsing and consciousness is probably comparable to the knowledge of astronomy about 600 years ago. For example, Tycho Brahe’s meticulous but relatively primitive astronomical measurements, eventually led to Newton’s laws of planetary motion.
2. This study of spirals, has produced some interesting properties, but more importantly, reproducible numerical values, relationships, and universal constants. It is hoped that this paper will contribute in a similar way, as did Tycho Brahe, to further understanding the structure of the universe, but in this case, there is also the prize of understanding consciousness. This paper’s findings will not only need to be consistent with a future “unified theory of everything”, but will also provide a means to test parts of it. With this in mind, the remainder of this section summarizes some of the major findings in this article that may be involved in understanding consciousness and its place in the universe.
3. As stated earlier, an important feature of conical helices is that they always have a vertical axis. It would therefore seem that Gravity has a fundamental influence in producing them.
4. All the “spirals” display the characteristics of Type 3 fields. Elsewhere, (in Reference 1 page 226), these are explained in detail where it is shown that Type 3 fields are impervious to electro-magnetic fields. Unlike other types of dowsable fields, they and their source, are unaffected by light/photons, electromagnetic fields in general, and are not diminished by a Faraday Screen, or attenuated by being surrounded by a thick metal container.
5. The above point 4, coupled with vertical axes, suggests that the creation of the phenomenon of “spirals” involves one of the two fundamental long-range forces of nature – gravity, but not by the other - electro-magnetism. (This does not apply to other dowsable fields).
6. The strong north-south orientation of spirals suggests that the Earth’s spin is also involved in the generation of conical helices. The position of the North Pole is determined by the spin of the Earth on its axis with respect to the plane of the Earth’s orbit around the Sun. An additional component of conical helices is therefore a cosmic and rotational influence.
7. In contrast to the previous point, it does not seem to affect the nature, the geometry, or the location of the “spirals” associated with physical matter, if the latter is spinning or not. The mechanism that produces conical helices is therefore

non-physical, (in the normal accepted meaning of the word), and has the property of being unaffected by spin. This suggests that the formation of conical helices requires a process with a mathematical transformation of axes that is invariant to rotation.

8. There is a preference for measurements within a spiral, and along a row of spirals, to produce an arithmetic series. This seem unusual, because when studying earth energies and mind generated experiments, geometric series are just as prevalent as arithmetic.
9. It cannot be co-incidence to have found three key angles (and universal constants), $\arcsin 1/3$, $1/5$, $1/7$. The geometry associated with these angles is shown in Figure 23. If the reader prefers geometry, then Pythagoras theorem applies to these basic right-angled triangles. Alternatively, if trigonometry is preferred the angles are:

$$\arcsin 1/3 = 19.4712^\circ \quad \arcsin 1/5 = 11.537^\circ \quad \arcsin 1/7 = 8.213^\circ.$$

In other similar research work, arc sine $1/9$ has also been found, and so continues the series. This ties up with other research work where self-replicating geometry, repeating patterns, and “reflections” have been found.

The Three Key Angles

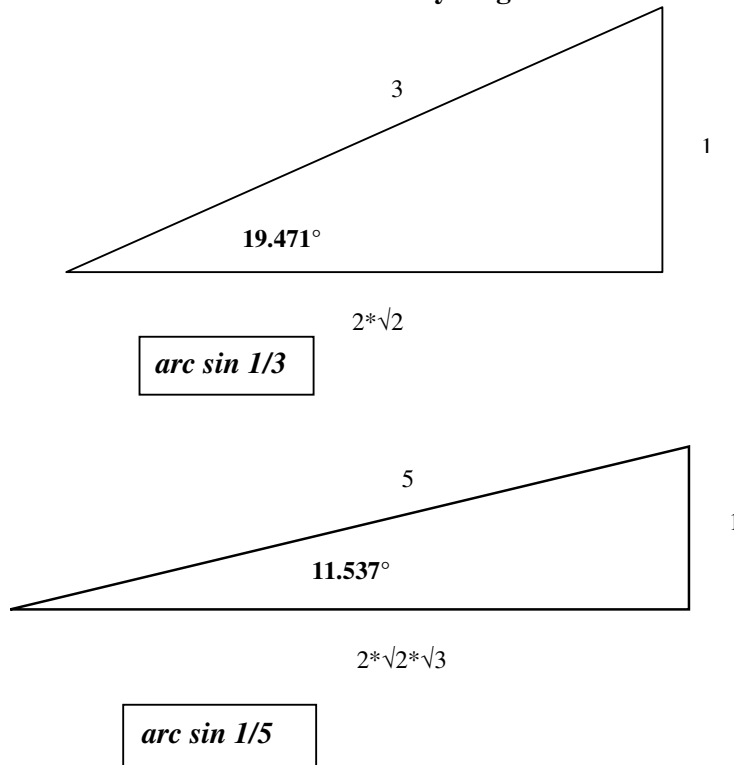

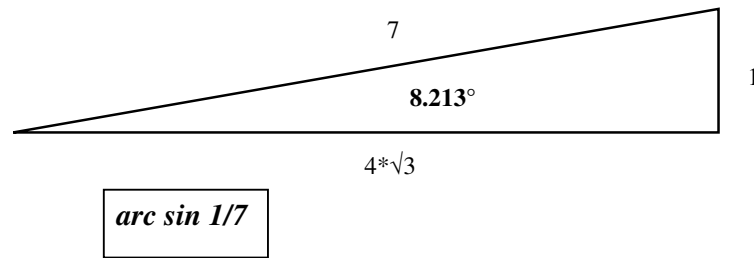

Fig 23

10. Even a cursory internet search of academic papers gives numerous other examples where these angles occur. Diverse topics range from columnar vortices; cosmology; Ampere and dipole force laws and null-points; static and dynamic studies of polyhedral structures, vortices, and torroids; astronomical events on the surfaces of Jupiter and Saturn; statistical analysis of the size of birds; flight dynamics; chemistry and molecular structures; fluid dynamics, including bow waves and the Kelvin Wedge; climate studies; aging bone studies; cognitive behavior; quantum mechanics for spin $\frac{1}{2}$ particles in a magnetic field; etc.
11. The implied conclusion of points 9 and 10 above is that dowsable conical helices seem inherently connected to the structure of the universe – not just an isolated random phenomenon.
12. The validity of dowsing relevant photographs is again well demonstrated by the consistency with on-site measurements. It makes no difference if the photographs are thousands of miles away from their subject matter, on the other side of the world. Using the vocabulary of quantum physics, this would seem to be an example of non-local entanglement, with instant connectivity.
13. This paper therefore adds yet more evidence of the commonality between the structure of the universe, information, geometry in general and polyhedral and vortex structures in particular, and how all of these link with connectivity and consciousness.
14. The concept in point 13 is not new, and has numerous names ranging from the Akashic Record from thousands of years ago, to the Zero Point Field, the Information Field, or more recently, the Cosmic Internet.
15. So what causes these observed dowsable fields? This research work supports the theory that these dowsable fields are a natural result of the interaction of the geometry, and the physical presence of matter with a universal field containing information. Excitingly, this paper also provides evidence that the mind, as well as matter, interacts with this Information Field. With the appropriate intent of the observer, the mind detects changes in the Information Field caused by matter, mind or spin interacting with the Information Field. The observer perceives these changes as spirals, lines, or any other dowsable pattern. What we seem to be measuring are changes in the quantum phase interference patterns that form part of the structure of the Information Field. The implied conclusion is that auras, lines, spirals, and other dowsable patterns we perceive are not physically there –

“they are all in the mind”. The process is analogous to everyday sight. “Seeing” is a model of an image in the brain, not a physical image on the retina in the eye.

16. The implication of this research is that the same mechanism as above, explains all forms of dowsing, be it on-site dowsing for underground objects, map dowsing, photograph dowsing, dowsing for information, or the associated phenomena of remote viewing, healing, telepathy, etc, and are all linked to the structure of the universe.
17. The Information Field structure of the universe is obviously not just confined to dowsing (which in this article is used for quantitative research), but explains findings in such diverse disciplines as cosmology, quantum physics, evolutionary biology, as well as consciousness research.
18. What is the connection between cones, spirals, angles whose sine's are $1/3$, $1/5$, and $1/7$, and the Information Field? Figures 25, 26, and 27 may give a strong clue.

A Standard Torus

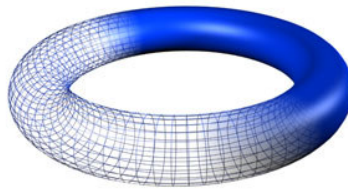

Figure 24

But first, we first need to consider a torus. Figure 24 is a representation of a standard 3-D torus, popularly known as a doughnut, or bagel shape. In the model about to be developed, let us assume that these infinitesimally small quantum tori are spinning like vortices to form the Information Field.

A Torus can spin or rotate in 3 different ways:-

1. If, for example, it is flexible, or a fluid, or an energy field, it can roll in and out on itself. Analogies of this could be vortices in a tornado, or water flowing down a plughole.
2. It can rotate about a vertical axis, so it appears to remain in the same place.
3. It can rotate about a horizontal axis like a paddle wheel.

Combining motions 1 and 2 above, and visualizing a point on the surface, produces a circular spiral.

In order to illustrate how it is possible to produce a cone, let us consider a torus where the hole in the centre has the same diameter as the thickness of the torus. Figure 25 represents a cross-section through the centre of our special torus, where each component has a radius (a), and diameter ($2a$). i.e. where the thickness of the torus ($2a$) equals the diameter of the central hole. A cone that just fits inside the central hole has a base radius (a) where it touches the inside of the torus. If the length of the outside of this cone is equal to the outer radius of the torus ($3a$), the half-angle of the cone is arcsine ($a/3a$) = $1/3$ which is 19.471° .

Single Torus

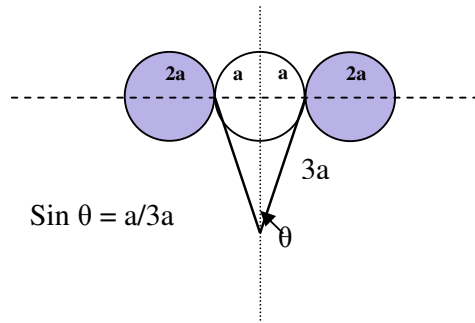

Figure 25

Figure 26 represents the torus in figure 25 surrounded by another torus with equal thickness. In this case, the cone that just fits inside the central hole still has a base radius of a where it touches the inside of the central torus. However, if the length of the outside of this cone is equal to the outer radius of the torus ($5a$), the half-angle of the cone is arcsine ($a/5a$) = $1/5$ which is 11.537° .

Interestingly, if one torus is rotating in one direction the other rotates in the opposite direction. This may explain alternate spirals being clockwise and anti-clockwise.

Two Concentric Tori

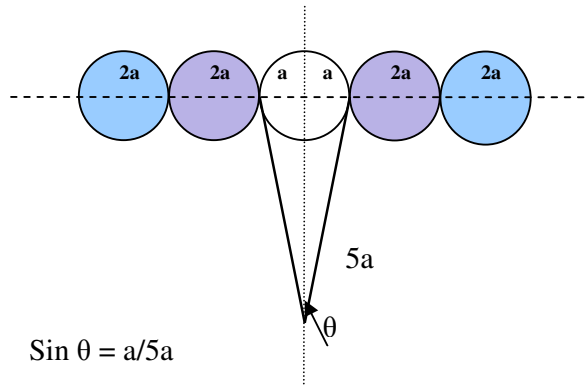

Figure 26

A similar logic applies to figure 27, where there are 3 concentric tori, and the half-angle of a similarly drawn cone is arcsine $1/7$ which is 8.213° .

A possible inference is that the conical helices being observed at the macro level, replicate the structure of the Information Field. At the infinitesimally small Planck quantum level, the basic units of the Information Field could therefore be similar to vortices and rotating tori.

The next obvious question is why should cones at the quantum level appear several metres tall in our minds? The mechanism for this could be yet another example of fractal geometry, whereby phenomena at the micro and quantum level become reproduced at the macro level. Although not fully explaining why an observer

perceives conical helices, analogies include a rainbow, a hologram, or self-replicating geometry. In all these examples what appears as large objects, result from the manifestation of very small phenomena.

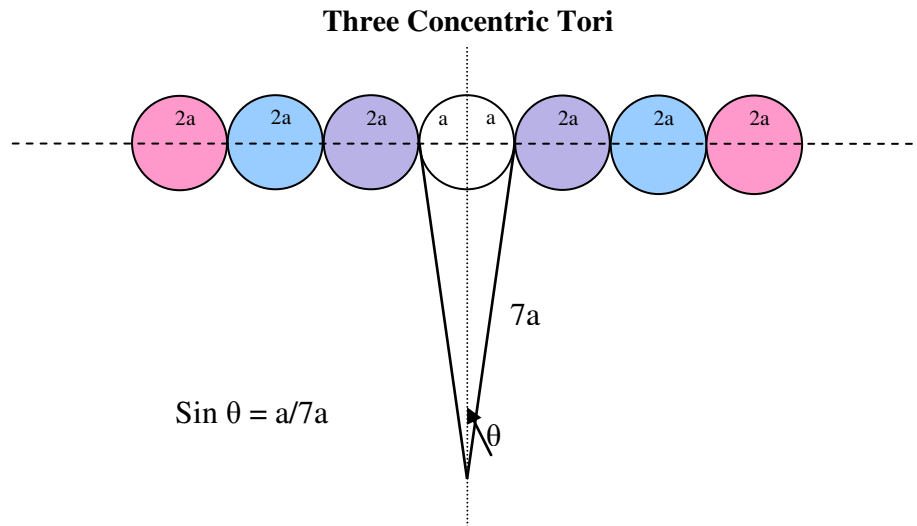

Figure 27

From the results of measurements detailed in this paper, and from other sources, the basic structure of the universe seems not like a “*vibrating string theory*”, but more like a “*spinning bagel theory*”!

The overall conclusion to this article is that consciousness is more than just a brain in a skull. It involves the structure of the Universe. We are indeed living in exciting times!

Further Research

Following up the findings in this article are suggested areas for further research. These are set out below.

1. Discovering the cause of the perturbations that affect the shape of the cones. The reason(s) for this could lead to further fundamental discoveries.
2. When measuring the turns of spirals, or the separation distances between spirals, what causes the perturbations to a simple mathematical progression?
3. Why is there a perceived precession of the overlapping apexes of a pair of conical helices? Is this connected to the perturbations in points 1 and 2 above?
4. What effect, if any, does the Earth’s rotation have on the above experimental results?
5. There may be some insight in attempting to transform the conical helices described in this paper, into a hologram pattern of interference fringes, and using this as a basis for exploring the structure of the Information Field.
6. Similarly, what are the mathematical transformations that convert spinning tori into conical helices possessing the properties outlined in this paper?

7. Why there are $3\frac{1}{2}$ turns in a conical helix, and what is the connection to those musical octaves comprising 7 notes.
8. Are all spirals the same, as seems to be implied by this research?
9. What causes dowsable spirals to appear the same if originating from differing sources?
10. In figure 16, are we just measuring conical spirals in different directions, or is the changing orientation of the observer an additional factor?
11. Why are there anomalies when graphs of distances between spirals and their source, and graphs of spiral diameters are extrapolated to zero mass?
12. Further experimentation is required to prove if the height of a cone having a heavy mass source is significantly higher than the height of a cone from a low mass source.
13. More accurate measurements are required of maxima & minima of cone angles to confirm if that they are exactly 19.471° , 11.537° , and 8.213° .
14. For helices generated by 2 intersecting lines, does the configuration of the vertical column of spiral reflections change at 11.537° , and spiral flow at 8.21° ?
15. Further research is required to find the accurate null angle between intersecting lines, causing spirals to reverse from clockwise to anti-clockwise.
16. Further research is required into the trajectory of the perceived flow. In fact what is flowing? Does the helix have a constant "bore"? Is the perceived flow at a constant velocity? Does the perceived flow accelerate?
17. Is energy involved, or is a potential difference being detected?
18. Why is there a mirror image between pairs of conical helices? This seems to apply to both vertical and horizontal "reflections".
19. As discussed in points 4 and 5 above, conical helices are unaffected by electromagnetic fields, but strongly affected by gravity. It is therefore suggested that the further study of conical helices may be a good method of exploring the interaction between the Information Field and gravity, and how and why the Information Field produces conical helices.

As always in research, there are more queries than answers, and it is interesting to note that the number of items in the conclusions to this article equals the number of suggested topics for future research! It is hoped that this article may provide a general motivation to hunt for other universal constants, using the proven technique of dowsing, to further the study of consciousness.

Acknowledgements

Acknowledgements are due to the Dowsing Research Group members who inspired this avenue of research, and reviewed some of the experiments, observations, and conclusions discussed in this article. In particular, Bob Sephton and Jim Lyons, initially assisted the author in some of the experiments, and helped in placing the findings of the key angles in the wider scientific context.

Bibliography

- 1 Jeffrey Keen; *Consciousness, Intent, and the Structure of the Universe*; Trafford; 2005; 1-4120-4512-6; <http://www.trafford.com/robots/04-2320.html>

- 2 Lawrence Edwards; *The Vortex of Life*; Floris; 1993; 0-86315-148-5
- 3 Ervin Laszlo; *Science and the Akashic Field*; Inner Traditions; 2004; 1-59477-042-5
- 4 Jude Curran; *The Wave*; O-Books; 2005; 1-905047-33-9
- 5 Dean Radin; *Entangled Minds*; Paraview; 2006; 1-4165-1677-8