

# CAMBRIAN

## *model rail*

NARROW GAUGE

COMPONENTS



Jun 2022

[cambrianmodelrail.co.uk](http://cambrianmodelrail.co.uk)

**for 16mm Scale**

# cambrianmodelrail.co.uk

## Cambrian 16mm Scale Catalogue June 2022

Components are injection moulded in medium grey polystyrene (N prefixed items), with some metal parts where appropriate. Prices include VAT at 20%.

**Price codes:** C - £1.80; D - £2.10; E - £2.70; F - £3.00; G - £3.30; H - £3.90; I - £4.40; J - £5.40; K - £6.00; M - £7.20; N - £9.00; O - £10.80, T - £8.40

## BOGIES

Sold in pairs for one wagon/coach – with frames, stretchers, bolsters & pivot bolts. Can also be used for 45mm gauge using plasticard to lengthen stretchers (3mm each side). Higher postage rate applies to bogies.

### **NB1 Lynton & Barnstaple 4' wb Freight Bogies Price code N**

As fitted to most L & B bogie wagons. Requires 24mm wheels & bearings. Note that the frame spacing is reduced by 6mm to avoid clearance problems & to allow the stretchers to be used for other bogies. (L & B bogies were wider than usual for 2ft. gauge)

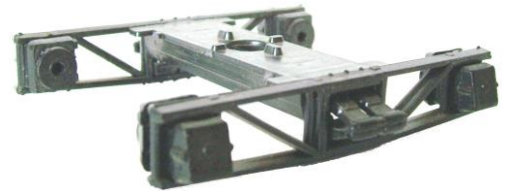

### **NB2 Lynton & Barnstaple 3' wb Freight Bogies Price code N**

Smaller wheelbase bogies as fitted to wagon No.28312 (as drawn by Mike King). Requires 24mm wheels & bearings. Can also be made up without bearings. Smaller wheels could be fitted to make a pair of 4 wheel wagons, or even used for a bogie diesel loco.

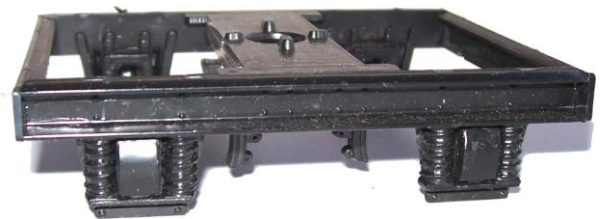

### **NB3 "Fox" Pressed Steel Bogies - 3' 3" wb Price code N**

As fitted to Victoria Railways Narrow Gauge stock. Similar bogies were fitted to the Leek & Manifold open wagons and transporters. See SMT No.66 November '93. Requires wheels & bearings as NB1. Can also be made up without bearings.

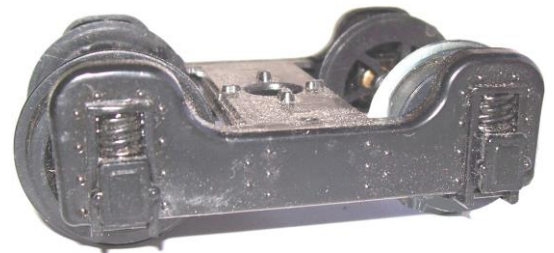

### **NB4 L & B Passenger Bogies - 4' 4"wb Price code O**

Distinctive bogies as fitted to L & B coaches. Requires 24mm wheels and CA13 bearings to complete. The axleboxes have working plastic springs. (Will take 2kg. per bogie)

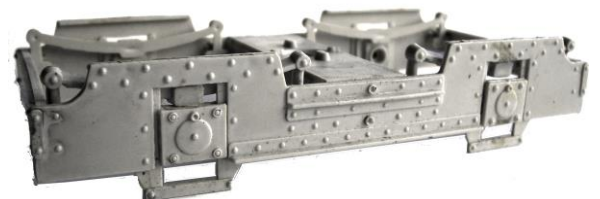

### **NB5 Rye & Camber Coach Bogies Price code N**

Channel framed bogies fitted to the R & C coaches. Could also be used for wagon chassis. 2mm axle holes. 20mm wheels required.



## AXLEGUARDS

### NA1 Talylyn Railway Axleguards Price code I

Set of four. As used on various TR wagons. From drawings/photos in Sept '65 MRN. Pin or glue in place.



### NA2 "Record" Wagon Axleboxes Price code F

Set of four. As fitted to tipper wagons. From a drawing in MRN p306 1961. Can be fitted direct to plastic solebars, or to a rectangle of plasticard & pinned to wooden ones. Can also be drilled through for inside bearings.



### NA8 W & L Type Wagon Axleguards Price code J

Set of 4 based on W & L wagons. Use Brandbright RSA28B bearings or plastic bearings supplied. Separate springs & axleboxes give a degree of springing to the axles. With some extra work, the springs could be fitted behind the "W" irons, which NG stock sometimes had.



### NA22 "Sandy River" Axleguards Price code J

Set of 4 "inside sprung" based on those fitted to the Sandy River (US) railcars converted from road vehicles – see NA20 for radiator and NA29/30 for headlights and cowcatcher.

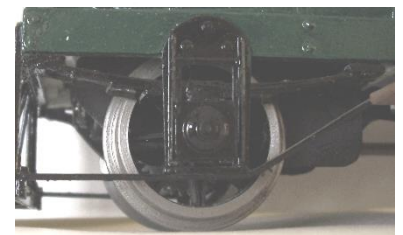
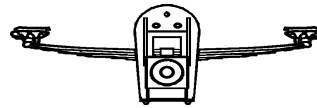

### NA26 Simplex Loco Axleguards Price code J

Set of 4 as fitted to 8/12hp locos. Also includes bracket for skid bar. Could also be used for small wagons.

### NA27 "Fowler" Axleboxes Price code J

Set of 4 axleboxes, plus springs, "chain tensioners" and small flanged "boss". Baseplate is approx. 21mm wide x 19mm high

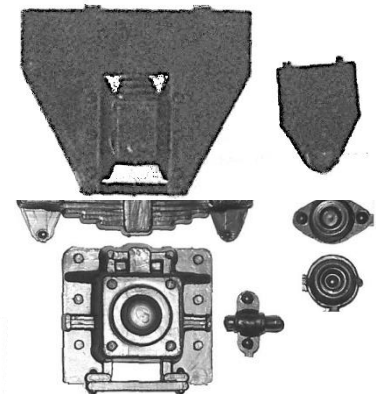

### NA28 GVT Coach Axleguards Price code J

Set of four axleguards



### NA34 Simplex "Axleguards" Price code J

Set of four, as fitted to plate-framed locos. Axlebox & spring with hangers. Could also be fitted to other outside framed locos.



### NA38 GVT Wagon Axleguards Price code J

Set of four. Includes a 3D printed back.

## BRAKEGEAR

### NA9 Set of 4 Brakeshoes Price code F

Brakeshoes & Hangers for four shoe brakegear - use two sets for 8 shoe type. Based on W & L type, for 24 - 30mm wheels.



### NA10 Glyn Valley type Brakegear Price code H

Set of 4 shoes & push rods as fitted to GVT coaches (non-working). For 5ft. 6in. wheelbase (88mm) and 24 - 26mm wheels. Picture shows centre bar still attached to moulding.





## FITTINGS

### NA3 Talylyn-type Coach Door Handles Price code G

For 12 doors, with dummy hinges. Also includes parts to make working hinges/catches for inwards opening guard's doors. (Two mouldings per pack)

### NA4 Hooks & eyes for safety chains Price code G

8 hooks & eyes, 4 larger hooks & 2 hooks for 3-link couplings. (Two mouldings per pack)

### NA5 Nuts & Bolts Price code F

Add the finishing touch with these. Approx. 180, selection of three sizes. (Two mouldings per pack)

### NA6 Brake Handwheels etc. Price code E

2 brake wheels, 3 round & 4 curly valvewheels, plus 2 sizes of pressure gauges. Smokebox door handle & loco regulator

### NA7 Rivet Heads Price code F

Approx. 230. Even more fun to fit than NA5!  
1.5mm dia. Not suitable for hot surfaces.  
(Two mouldings per pack)

### NA11 Centre Buffer Coupling Price code I

Pair of buffers with metal hook. The moulded "bolt heads can be cut off to reveal holes for fixing with pins or small bolts. Requires chain.

### NA12 Coach / Wagon Buffers Price code K

Set of four sprung buffers. Based on Talylyn type.

### NA13 Handrail Knobs Price code F

12 per pack. 8 with hole right through,  
& 4 with half depth hole for ends. For 1.5mm/z" rod

### NA14 Loco Headlight Price code H

Large light based on L & B type. With 9mm dia. lens.  
Can be lit with L1/L10/L19 LED. Supplied unassembled.

### NA15 Coach Door Vents Price code E

Set of four over-door vents, based on GVT type.

### NA16 Radiator Price code C

Simplex type. Note: two are required for a free-standing radiator. 41mm high x 24mm wide.

### NA17 Louvres Price code F

For detailing diesels locos. etc. Two each of 8 louvres x 18mm; 8 louvres x 12mm; 12 louvres x 8.5mm.  
Pre-spaced, fit in position with solvent & cut from sprue when set.

Top picture shows appearance of louvres when fitted. See also illustration for NA29 on the next page.

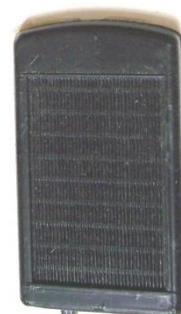
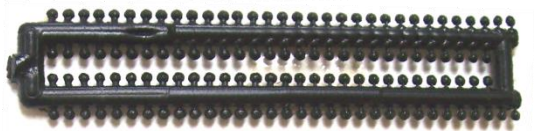
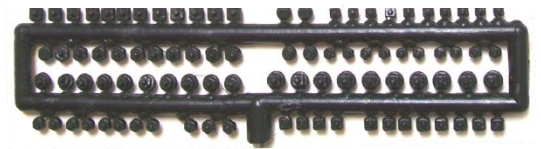
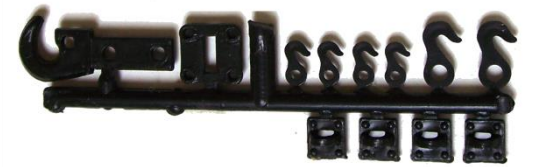

**NA18 Plastic Box Price code G**

Open top box—use for a quick “tub” wagon body— decorate with plastic strip & NA7 Rivets. 75mm long x 50mm wide & 35mm high. (not shown). Higher postage rate applies to this item.



**NA19 Plastic Box Price code F**

Larger size: 100mm long x 60mm wide & 25mm high. (shown right)  
Higher postage rate applies to this item.



**NA20 Radiator – Ford “A” type Price code C**

Use on railbuses e.g. Irish or Sandy River. It can, of course, also be used for road vehicles.  
31.5mm high x 29.5mm wide



**NA21 Detailing parts for Simplex locos Price code K**

Brake wheel, handle & supporting frame; 4 sandboxes, chequer plate for driver’s footplate; gearbox end detail, starter handle guide, clutch pedal and bracket for silencer.

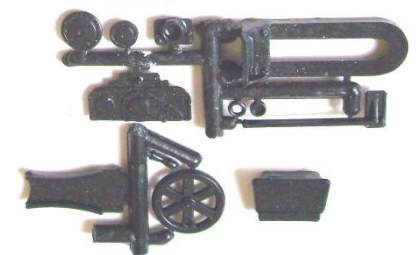

**NA23 Radiator Panel Price code C**

Flat Panel for Locos or larger railcars, 48mm h x 29mm w.  
Based on the roof-mounted radiators on Belgian SNCV “Autorails”.



**NA24 Diesel Horns Price code E**

One each of 20mm long & 25mm long (supplied as "halves")  
Based on the horns on SNCV “Autorails”.



**NA25 Pressed-type Loco Seat Price code C**

As used on small diesel locos, 20mm wide x 19mm deep.

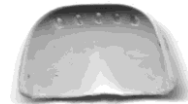

**NA29 Headlight Price code F**

Suitable for railcars and diesel locos. Approx. 12mm dia. at front.  
Includes clear “lens”. As fitted to Sandy River Track Autos >  
(Picture also shows the largest size of NA17 Louvres)

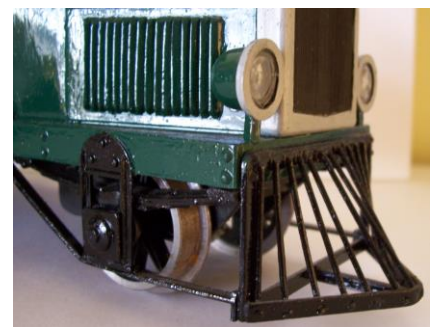

**NA30 Cowcatcher Price code I**

Requires assembly. Plastic frame with wire for the “bars”. Size of backframe 48mm wide x 24mm high.  
As fitted to Sandy River Track Autos etc.



**NA31 Coach end steps Price code F**

Set of four, based on GVT type



**NA32 Loco Brake Standard Price code F**

With handle, top ring and square base.  
Approx. 57mm high to top of handle boss (can be shortened). Requires assembly.



**NA33 Guard's Van Brake Standard Price code F**

With wheel & round base, requires assembly  
Approx. 56mm high to top of handle boss.

The height can be altered by shortening the column before assembly.



**NA35 "Ruston" Radiator Grille Price code C**

Based on the 20DL locotype. 19.5mm x 17mm.  
Other Ruston locos had similar grilles.



**NA36 Coach Roof Brackets Price code H**

Use for coaches with end verandahs.  
Based on Ziller coach type. Set of four. 20mm along edges. Could also be used as brackets for wall-mounted station lamps.

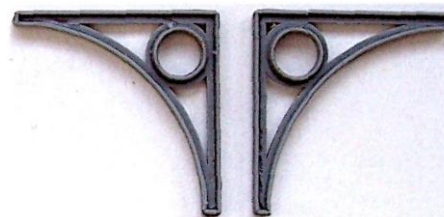

**NA37 Platform Canopy Valance Price code I**

Pack of two. 144mm by 26mm per length.  
Can be joined end to end, or split to make a slight slope for the ends of a canopy.

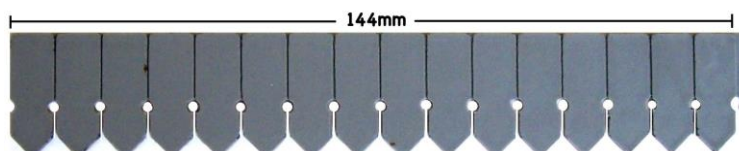

**SIGNAL PARTS**

**NS1 Signal Ladder Price code F**

Approx. 200mm long – Can be joined to make a longer ladder. Also useful for water tanks, tank wagon access ladders etc.  
It is possible to curve the ladder, if done carefully.



**NS2 Signal Parts Price code M**

Arm & back blind, lamp & bracket, finial, balance arm and mounting plate, platform support & handrail etc. Based on L & B "Evans & O'Donnell" type, with instructions. Includes spectacle material.

Lamp can be fitted with L1 LED.

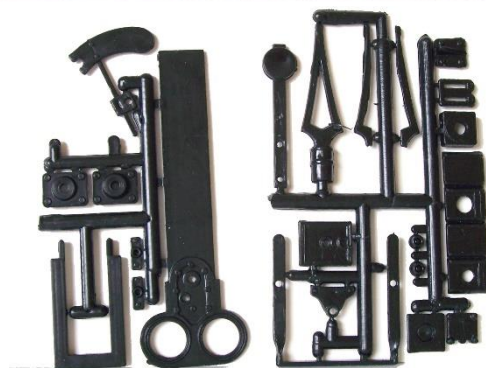

**NS3 Brackets for junction signals Price code H**

To support cross bar, with 3 rings in the angle.  
Could also be used for wall-mounted gas lamps or platform canopy supports (Crediton station has this type of bracket). 2 brackets per pack.  
Dimensions: 48mm x 55mm along straight edges.

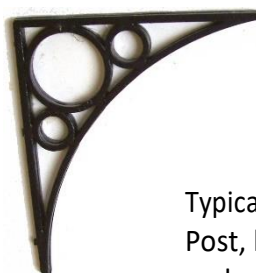

Typical assembled signal.  
Post, base, platform and rodding are not included in NS2.





## WHEELS

Plastic wheels, approx. 6mm thick and 2mm deep flanges.

### NW2 30mm 8 spoke Price Code H

Set of 4  
For 2mm axles.

### NW3 24mm with six curly spokes Price code H

Set of 4. Used on slate wagons etc.  
For 2mm axles.

### NW4 20mm Five spokes Price code H

Set of 4. Can be used with NB2 Bogies for making 4  
wheel wagons. For 2mm axles.

### NW5 25mm Disc Price code H

Set of four. For 4mm dia. axles

### NW6 21mm Spoked Loco wheels Price code K

For Faller battery locos. Set of six for 2mm axles.

### NW7 Wheel Set for "Excelsior" 0-4-2T Price code J

Set of 4 driving wheels & two trailing wheels. 19mm / 13mm dia.  
Drivers: 8" axle, pony 2mm axle.  
Drawings of the "Excelsior" loco are in the "Kerry  
Tramway" book – Plateway Press.



## TRANSFERS

### NG01/3 Welsh Highland Lettering Price Code T

For vans and wagons. 2 sheets



### NG08/3 Tallylyn Coaches Price Code T

2 sheets



- We prefer to process all orders via our on-line shop at [www.cambrianmodelrail](http://www.cambrianmodelrail) where you can see availability and pay by credit or debit card.
- We can also take orders by phone or post, where cheques need to be payable to Cambrian Model Rail Ltd.

Cambrian Model Rail Ltd

PO Box 85

Greenhithe

Kent

DA10 9DN

01322 515672

[cmr@cambrianmodelrail.co.uk](mailto:cmr@cambrianmodelrail.co.uk)